

# Yealink



## Yealink T2 Series and T19(P) E2 IP Phones User Guide

Version 84.80  
Aug. 2019

# Copyright

## **Copyright © 2019 YEALINK(XIAMEN) NETWORK TECHNOLOGY**

Copyright © 2019 Yealink (Xiamen) Network Technology CO., LTD. All rights reserved. No parts of this publication may be reproduced or transmitted in any form or by any means, electronic or mechanical, photocopying, recording, or otherwise, for any purpose, without the express written permission of Yealink (Xiamen) Network Technology CO., LTD. Under the law, reproducing includes translating into another language or format.

When this publication is made available on media, Yealink (Xiamen) Network Technology CO., LTD. gives its consent to downloading and printing copies of the content provided in this file only for private use but not for redistribution. No parts of this publication may be subject to alteration, modification or commercial use. Yealink (Xiamen) Network Technology CO., LTD. will not be liable for any damages arising from use of an illegally modified or altered publication.

## Trademarks

Yealink®, the logo and the name and marks is trademark of Yealink (Xiamen) Network Technology CO., LTD, which are registered legally in China, the United States, EU (European Union) and other countries.

All other trademarks belong to their respective owners. Without Yealink's express written permission, recipient shall not reproduce or transmit any portion hereof in any form or by any means, with any purpose other than personal use.

## Warranty

### (1) **Warranty**

THE SPECIFICATIONS AND INFORMATION REGARDING THE PRODUCTS IN THIS GUIDE ARE SUBJECT TO CHANGE WITHOUT NOTICE. ALL STATEMENTS, INFORMATION, AND RECOMMENDATIONS IN THIS GUIDE ARE BELIEVED TO BE ACCURATE AND PRESENTED WITHOUT WARRANTY OF ANY KIND, EXPRESS OR IMPLIED. USERS MUST TAKE FULL RESPONSIBILITY FOR THEIR APPLICATION OF PRODUCTS.

### (2) **Disclaimer**

YEALINK (XIAMEN) NETWORK TECHNOLOGY CO., LTD. MAKES NO WARRANTY OF ANY KIND WITH REGARD TO THIS GUIDE, INCLUDING, BUT NOT LIMITED TO, THE IMPLIED WARRANTIES OF MERCHANTABILITY AND FITNESS FOR A PARTICULAR PURPOSE. Yealink (Xiamen) Network Technology CO., LTD. shall not be liable for errors contained herein nor for incidental or consequential damages in connection with the furnishing, performance, or use of this guide.

### (3) **Limitation of Liability**

Yealink and/or its respective suppliers are not responsible for the suitability of the information contained in this document for any reason. The information is provided "as is", and Yealink does not provide any warranty and is subject to change without notice. All risks other than risks caused by use of the information are borne by the recipient. In no event, even if Yealink has been suggested the occurrence of damages that are direct, consequential, incidental, special, punitive or whatsoever (Including but not limited to loss of business profit, business interruption or loss of business information), shall not be liable for these damages.

## End User License Agreement

This End User License Agreement ("EULA") is a legal agreement between you and Yealink. By installing, copying or otherwise using the Products, you: (1) agree to be bounded by the terms of this EULA, (2) you are the owner or an authorized user of the device, and (3) you represent and warrant that you have the right, authority and capacity to enter into this agreement and to abide by all its terms and conditions, just as if you had signed it. The EULA for this product is available on the Yealink Support page for the product.

## Patent Information

China, the United States, EU (European Union) and other countries are protecting one or more patents of accompanying products and/or patents being applied by Yealink.

## Customer Feedback

We are striving to improve our documentation quality and we appreciate your feedback. Email your opinions and comments to [DocsFeedback@yealink.com](mailto:DocsFeedback@yealink.com).

## Technical Support

Visit Yealink WIKI (<http://support.yealink.com/>) for the latest firmware, guides, FAQ, Product documents, and more. For better service, we sincerely recommend that you use Yealink Ticketing system (<https://ticket.yealink.com>) to submit all your technical issues.

## GNU GPL INFORMATION

Yealink phone firmware contains third-party software under the GNU General Public License (GPL). Yealink uses software under the specific terms of the GPL. Please refer to the GPL for the exact terms and conditions of the license.

The original GPL license, source code of components licensed under GPL and used in Yealink products can be downloaded online: [http://www.yealink.com/onepage\\_83.html](http://www.yealink.com/onepage_83.html).

# Table of Contents

<b>Table of Contents</b> .....	<b>1</b>
<b>Before You Begin</b> .....	<b>9</b>
Related Documentation .....	9
<b>Getting Started</b> .....	<b>10</b>
Hardware Overview .....	10
T2X Series Hardware .....	11
Power LED Indicator .....	12
Line Key LED .....	12
Screen and Icons .....	13
Idle Screen .....	13
Calls Screen .....	14
Icons in the Status Bar .....	15
T29G Icons in the Status Bar .....	15
T27G Icons in the Status Bar .....	16
T23G/T23P/T21(P) E2/T19(P) E2 Icons in the Status Bar .....	16
Line Key Icons .....	17
T29G Line Key Icons .....	17
T27G Line Key Icons .....	18
T23G/T23P/T21(P) E2 Line Key Icons .....	18
Entering Characters .....	18
<b>Call Features</b> .....	<b>19</b>
Changing the Default Account .....	19
Placing Calls .....	19
Placing a Call from the Dialer .....	20
Placing Multiple Calls .....	20
Placing a Call with a Speed Dial Key .....	20
Placing a Call Back to the Last Incoming Number .....	21
Redialing a Number .....	21
Dialing a Hotline Number .....	22
Placing an International Call .....	22
Placing a Call from the Call History .....	22
Placing a Call from the Directory .....	22
Placing an Anonymous Call .....	23
Placing Calls to Google Contacts .....	24
Placing an Emergency Call from a Locked Phone .....	24
Answering Calls .....	24
Answering a Call .....	24
Answering a Call When in a Call .....	25
Answering a Call Automatically .....	25
Switching Among the Handset, Speakerphone and Headset Modes .....	26

Disabling Call Waiting .....	26
Silencing or Rejecting Incoming Calls .....	26
Silencing a Call .....	27
Rejecting a Call Manually .....	27
Rejecting Anonymous Calls .....	27
Rejecting Calls with Do Not Disturb (DND) .....	27
Rejecting Calls with DND on All Lines .....	28
Rejecting Calls with DND on a Specific Line .....	28
Deactivating DND .....	29
Ending Calls .....	29
Redialing a Call Automatically .....	30
Muting/Unmuting Audio .....	30
Keep Mute .....	31
Holding and Resuming Calls .....	31
Holding a Call .....	31
Resuming a Held Call .....	32
Redirecting Incoming Calls .....	32
Forwarding All Incoming Calls to a Contact .....	32
Forwarding All Incoming Calls on All Lines .....	33
Forwarding All Incoming Calls on a Specific Line .....	33
Deactivating Call Forward .....	34
Forwarding an Incoming Call Manually .....	34
Forwarding Incoming Calls with a Forward Key .....	34
Diverting Calls to a Contact .....	35
Transferring Calls .....	35
Performing a Blind Transfer .....	35
Performing a Semi-Attended/Attended Transfer .....	35
Performing Transfer with a Transfer Key .....	36
Setting a Transfer Key .....	36
Performing a Blind Transfer Using a Transfer Key .....	36
Performing a Semi-attended/Attended Using a Transfer Key .....	37
Performing a Call Transfer by Selecting a Transfer Mode .....	37
Conference Calls .....	38
Local Conference .....	38
Setting Up a Local Conference Call .....	38
Merging Two Calls into a Conference .....	39
Inviting a Transfer Target and a Transferee into a Conference .....	39
Holding or Resuming a Conference Call .....	39
Muting or Unmuting a Conference Call .....	39
Splitting a Conference Call .....	40
Managing Conference Participants .....	40
Ending a Conference Call .....	40
Network Conference .....	40
Setting Up a Network Conference .....	40

Recording Using a USB Flash Drive .....	41
Recording a Call .....	41
Pausing/Resuming a Recording .....	42
Stopping a Recording .....	42
Managing the Recordings .....	42
Listening to a Recording .....	42
Pausing/Resuming a Playback .....	43
Fast Forwarding/Rewinding a Playback .....	43
Deleting a Recorded Call .....	44
Viewing the Available Recording Time .....	44
Multicast Paging .....	44
Sending Multicast Paging .....	45
Setting a Multicast Paging Key .....	45
Sending a Paging by a Multicast Paging Key .....	46
Setting a Paging List Key .....	46
Setting a Paging Group .....	46
Sending Pages by a Paging List Key .....	47
Deleting a Paging Group .....	47
Receiving Multicast Paging .....	47
Managing a Paging Call .....	48
<b>Advanced Call Features .....</b>	<b>49</b>
Using Call Completion .....	49
Call Pickup .....	50
Picking up a Call Directly .....	50
Picking up a Group Call Directly .....	51
Picking up a Call with a Directed Pickup Key .....	51
Picking up a Call with a Group Pickup Key .....	52
Call Park and Call Retrieve .....	52
Parking or Retrieving a Call in the FAC Mode .....	52
Parking a Call in the FAC Mode .....	53
Retrieving a Parked Call in the FAC Mode .....	53
Parking or Retrieving a Call in the Transfer Mode .....	54
Parking a Call in the Transfer Mode .....	54
Retrieving a Parked Call in the Transfer Mode .....	54
Parking or Retrieving a Call with a Park or Retrieve Key .....	54
State Indicator of the Park/Retrieve key .....	55
Parking a Call using a Park Key .....	55
Retrieving a Parked Call using a Retrieve Key .....	55
Busy Lamp Field (BLF) .....	56
State Indicator of Remote Line by BLF Key .....	56
Audio Alert for BLF Pickup .....	57
Setting an Alert Tone for Monitored Lines .....	57
Visual Alert for BLF Pickup .....	57
Setting a BLF Key .....	57

Picking up a Remote Call by BLF Key .....	58
Transferring a Call by BLF Key .....	58
Performing a Blind Transfer .....	59
Performing a Semi-attended/Attended Transfer .....	59
Parking or Retrieving a Call by BLF Key .....	59
Parking a Call to a Monitored Line .....	59
Retrieving a Parked Call .....	59
BLF List .....	60
State Indicator of Remote Line by BLF List Key .....	60
Audio Alert for BLF Pickup .....	60
Setting an Alert Tone for Monitored Lines .....	61
Visual Alert for BLF Pickup .....	61
Ring Type for BLF Parked Call Monitor .....	61
Setting an Alert Tone for the BLF Parked Call Monitor .....	61
Visual Alert for BLF Parked Call Monitor .....	62
Picking up a Remote Call by BLF List Key .....	62
Transferring a Call by BLF List Key .....	62
Performing a Blind Transfer .....	63
Performing a Semi-attended/Attended Transfer .....	63
Parking a Call by a BLF List Key .....	63
Retrieving a Call by a BLF List Key .....	63
Barging in an Active Call by BLF List Key .....	63
Retrieving a Call Parked to the Monitored Line .....	64
Shared Line .....	64
State Indicator of Shared Line .....	64
Placing Calls on a Shared Line .....	65
Answering Calls on a Shared Line .....	65
Placing a Call on Public Hold .....	65
Placing a Call on Private Hold .....	66
Retrieving a Held Call on a Shared Line .....	66
Barging in an Active Call on a Shared Line .....	66
Pulling a Shared Call on a Shared Line .....	67
Intercom .....	67
State Indicator of the Intercom key .....	68
Placing an Intercom Call .....	68
Picking up an Incoming Call of the Target Extension .....	69
Answering an Intercom Call .....	69
Short Message Service (SMS) .....	70
Reading a Text Message .....	70
Sending a Text Message .....	70
Replying to a Text Message .....	71
Deleting a Text Message .....	71
Voice Mail .....	71
Setting the Voice Mail Code .....	71



Leaving Voice Mails .....	72
Listening to Voice Mails .....	72
Using the Hot Desking .....	72
Automatic Call Distribution (ACD) .....	73
State Indicator of ACD User .....	73
Logging into the ACD System .....	73
Changing the ACD Status .....	73
<b>Directory .....</b>	<b>75</b>
Local Directory .....	75
Managing the Local Directory Groups .....	75
Adding Contact Groups .....	75
Editing Contact Groups .....	75
Deleting Contact Groups .....	76
Managing the Local Directory Contacts .....	76
Adding Contacts .....	76
Viewing Contacts .....	76
Editing Contacts .....	76
Deleting a Contact .....	77
Deleting All Contacts .....	77
Moving a Local Directory Contact to Blacklist .....	77
Searching for Contacts .....	77
Favorites .....	78
Adding Favorites .....	78
Adding an Existing Contact to Your Favorites .....	78
Adding a New Contact to Your Favorites .....	78
Viewing Favorites .....	79
Reordering Favorites .....	79
Deleting Favorites .....	79
Blacklist .....	79
Adding a Blacklist Contact .....	79
Viewing Blacklist Contacts .....	80
Editing a Blacklist Contact .....	80
Deleting Blacklist Contacts .....	80
Deleting a Blacklist Contact .....	80
Deleting All Blacklist Contacts .....	80
Moving a Blacklist Contact to the Local Directory .....	81
Mobile Contacts .....	81
Saving a Mobile Contact to the Local Directory .....	81
Searching for Mobile Contacts .....	81
Updating the Mobile Contacts .....	82
Google Contacts .....	82
Viewing Google Contacts .....	82
Updating Google Contacts .....	83
Searching for Google Contacts .....	83

Remote Phone Book .....	83
Searching for Remote Phone Book Contacts .....	83
Viewing Remote Phone Book Contacts .....	83
Saving a Remote Phone Book Contact to the Local Directory .....	84
Saving a Remote Phone Book Contact to the Blacklist .....	84
<b>Call History .....</b>	<b>85</b>
Call History Icons .....	85
Viewing History Records .....	85
Saving a History Record to Local Directory .....	85
Saving a History Record to Blacklist .....	86
Deleting History Records .....	86
Deleting a Call Record .....	86
Deleting All Call Records .....	86
Disabling History Record .....	86
<b>Customizing Your Phone .....</b>	<b>88</b>
Changing the Administrator Password .....	88
Wallpaper .....	88
Changing Wallpaper on Idle Screen .....	89
Adding a Wallpaper from a USB Flash Drive .....	89
Screen Saver .....	89
Changing the Waiting Time for Screen Saver .....	89
Disabling Time & Date and Status Icons Display .....	89
Adding a Screen Saver from a USB Flash Drive .....	90
Setting the Screen Saver Type .....	90
Changing the Backlight and Time .....	91
Adjusting the Screen Contrast .....	91
Changing the Language .....	92
Time & Date .....	92
Setting the Time and Date Manually .....	92
Changing the Time and Date Format .....	92
Setting a Key as Send .....	93
Customizing the Soft Keys .....	93
Phone Lock .....	93
Setting the Phone Lock .....	94
Locking Your Phone Manually .....	94
Unlocking Your Phone .....	94
Changing Your Phone Unlock PIN .....	95
Extending the Line Key Labels .....	95
<b>Audio Settings .....</b>	<b>96</b>
Adjusting the Volume .....	96
Setting the Ring Tone .....	96
Setting a Ring Tone for the Phone .....	96
Setting a Ring Tone for an Account .....	96

Setting a Ring Tone for a Group .....	97
Setting a Ring Tone for a Contact .....	97
Disabling the Key Tone .....	97
<b>Optional Accessories with Your Phone .....</b>	<b>98</b>
Headset .....	98
Connecting the Analog Headset .....	99
Wireless Headset .....	99
Bluetooth Headset .....	99
USB Headset .....	99
Using Headsets .....	99
Bluetooth .....	100
Activating the Bluetooth Mode .....	100
Pairing and Connecting the Bluetooth Headset .....	100
Pairing and Connecting the Bluetooth-enabled Mobile Phone .....	101
Syncing the Mobile Contacts to the Phone .....	101
Enabling the Mobile Contacts Sync Feature .....	102
Viewing Your Mobile Contacts on the Phones .....	102
Disabling the Mobile Contacts Sync Feature .....	102
Viewing the Bluetooth Device Information .....	103
Editing Device Name of Your Phone .....	103
Deleting the Paired Bluetooth Device .....	103
Disconnecting the Bluetooth Device .....	104
Deactivating the Bluetooth Mode .....	104
Wireless Network .....	104
Activating the Wi-Fi Mode .....	104
Connecting to the Wireless Network .....	105
Connecting to an Available Wireless Network Manually .....	105
Connecting to the Wireless Network Using WPS .....	105
Adding a Wireless Network Manually .....	106
Viewing the Wireless Network Information .....	106
Managing the Saved Wireless Network .....	107
Disconnecting the Wireless Network Connection .....	107
Deactivating the Wi-Fi Mode .....	107
Expansion Module and Your Phone .....	108
Connecting the Expansion Module .....	108
Assigning the Features for Ext Keys .....	108
Adjusting the Contrast of the Expansion Module .....	108
Adjusting the Backlight of the Expansion Module .....	109
<b>Maintaining Your Phone .....</b>	<b>110</b>
Warnings .....	110
Investigating Warnings .....	110
Re-provisioning Your Phone .....	110
Clearing Warnings .....	111

Diagnosing the Network .....	111
Rebooting Your Phone .....	111
Resetting to Factory Settings .....	111
Updating the Phone Configuration .....	112
Clearing User's Personalized Configuration Settings .....	113
<b>Appendix - Menu Structure .....</b>	<b>114</b>
For the T29G Phone .....	114
For the T27G/T23P/T23G/T21(P) E2/T19(P) E2 Phone .....	115

---

## Before You Begin

---

This guide provides information you need to quickly use your new phone.

Firstly, verify with your system administrator that the IP network is ready for phone configuration. Also, be sure to read the Quick Start Guide which can be found in your phone package before you set up and use the phone. As you read this guide, keep in mind that some features are only configurable by your system administrator or determined by your phone environment. As a result, some features may not be enabled or may be operated differently on your phone. Additionally, the examples and graphics in this guide may not directly reflect what is displayed or is available on your phone screen.

### Note

This guide mainly takes T27G phones as an example.

This user guide contains information for the following Yealink products:

- T29G IP phones
- T27G IP phones
- T23P IP phones
- T23G IP phones
- T21(P) E2 IP phones (including T21 E2 and T21P E2 IP phones)
- T19(P) E2 IP phones (including T19 E2 and T19P E2 IP phones)

## Related Documentation

You can view more types of documents to make the phone to perform more functions.

You can obtain additional information on the following phones from Yealink Support:

- [IP Phone T29G](#)
- [IP Phone T27G](#)
- [IP Phone T23P](#)
- [IP Phone T23G](#)
- [IP Phone T21\(P\) E2](#)
- [IP Phone T19\(P\) E2](#)

The following types of related documents are available on each support page on [Yealink support page](#):

- Release Notes, which details bug fixes and feature enhancements when an update is released.
- Quick Start Guide, which describes how to assemble your phone and configure the basic phone features.
- Wall Mount Installation Guide, which provides detailed instructions on how to use an optional wall mount bracket to mount your phone on the wall.
- Administrator Guide, which provides detailed information on how to configure phone features for the system administrator.
- Regulatory Notice, which provides information about all regulatory and safety guidance.

You can also view other user documents which provide descriptions and examples for phone settings and features on the [Yealink support page](#).

## Getting Started

Before you use your phone, take some time to get familiar with its features and user interface.

The terms "the phone" and "your phone" refer to any of the IP phones. Unless specifically noted in this guide, all phone models are operated in similar ways.

### Topics

[Hardware Overview](#)

[Screen and Icons](#)

[Entering Characters](#)

## Hardware Overview

Understanding the phone hardware helps you easily use the phone's features.

Yealink T2 series phones have distinct hardware types:

Hardware	T19(P) E2	T23P/T23G/T21(P) E2	T27G	T29G
Screen	Grayscale	Grayscale	Grayscale	Color
Line Keys	No	Yes	Yes	Yes
USB Port	No	No	Yes	Yes

### Topics

[T2X Series Hardware](#)

[Power LED Indicator](#)

[Line Key LED](#)

[T2X Series Hardware](#)

## T2X Series Hardware

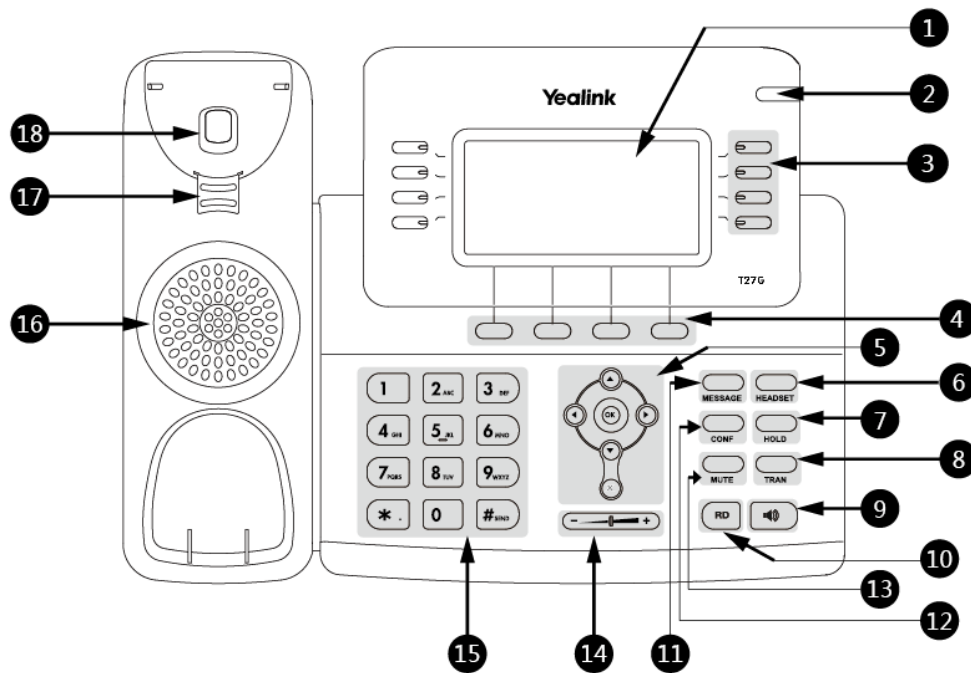

NO.	Item	Description
1	Phone Screen	Shows information about your phone, such as calls, messages, soft keys, time and date.
2	Power LED Indicator	Indicates call status, message status and phone's system status.
3	Line Keys	Access your phone lines and features. The T19(P) E2 phone does not have Line keys.
4	Soft Keys	Access the function displayed on the screen above the soft keys. The soft keys change depending on what you are doing at the time.
5	Navigation Keys	<ul style="list-style-type: none"> <li>• Scroll through information or options displayed on the screen.</li> <li>• Access History and Directory respectively.</li> </ul>
	OK Key	Confirms actions or answers incoming calls.
	Cancel Key	Cancels actions or rejects incoming calls. On the T23G/T23P/T21(P) E2 phones, you can also use it to mute or unmute an activate call. The T19(P) E2 phones do not have Cancel Key.
6	HEADSET Key	Toggles the headset mode on or off. The LED indicator glows green when the headset is activated. Only the T29G/T27G phones have a key light.
7	HOLD Key	Places a call on hold or resumes a held call. The T23G/T23P/T21(P) E2/T19(P) E2 phones do not have HOLD key.
8	TRAN Key	Transfers a call.

NO.	Item	Description
9	Speakerphone Key	Toggles the speakerphone (hands-free) mode or not.
10	RD Key	Redials a previously dialed number.
11	MESSAGE Key	Accesses your voice messages. The LED indicator glows green when receiving a new voice mail. The T19(P) E2 phones do not have a key light.
12	CONF Key	Creates a conference with another party. The T23G/T23P/T21(P) E2/T19(P) E2 IP phones do not have CONF key.
13	MUTE Key	Toggles the microphone on or off. The T23G/T23P/T21(P) E2 phones do not have MUTE key.
14	Volume Key	Adjust the volume of handset, headset, speaker.
15	Keypad keys	Allow you to enter numbers, letters, and special characters. If a menu item has an index number, you can use the keypad key to select the item.
16	Speaker	Provides ringer and speakerphone audio output.
17	Reversible Tab	Secures the handset in the handset cradle when the phone is mounted vertically. For more information on how to adjust the reversible tab, refer to <a href="#">Yealink Wall Mount Quick Installation Guide for Yealink IP Phones</a> .
18	Hookswitch	Connects or disconnects the phone from the phone line. The hookswitch is automatically activated when a user lifts the handset from the cradle to get a dial tone.

## Power LED Indicator

The power LED indicator indicates the call, message and phone's system status.

LED Status	Description
Solid red	The phone is initializing.
Fast-flashing red (0.3s)	The phone is ringing.
Slowly-flashing red (1s)	The phone receives a voice mail or text message.
Solid red for 0.5s and off for 3s alternately	The phone enters the power-saving mode. It is only available on the T29G phones.

### Note

The T19(P) E2 phone only has a yellow key light.

The above introduces the default LED status. Your system administrator can configure the status of the power LED indicator.

## Line Key LED

The line key LED indicators are associated with the status of phone lines and features.

**Line key LED** (associated with the phone line)

LED Status	Description
Solid green	The line is seized. The line is in conversation.



LED Status	Description
Fast-flashing green	The line receives an incoming call.
Slowly-flashing green	The call is placed on hold.
Off	The line is inactive.

**Line key LED** (configured as a page switch key)

LED Status	Description
Solid red	There is a call parked on the line, and the line key is not on the current page.
Fast-flashing green	The line receives an incoming call, and the line key is not on the current page.
Fast-flashing red	The monitored user whose line key is not on the current page receives an incoming call.
Off	The line keys are idle.

## Screen and Icons

The user screens and icon indicators can help you navigate and understand the important information on the phone's status.

### Topics

- [Idle Screen](#)
- [Calls Screen](#)
- [Icons in the Status Bar](#)
- [Line Key Icons](#)

## Idle Screen

The idle screen is made up of the status bar, line keys, and soft keys. The time & date in the status bar or middle of the screen varies by phone models.

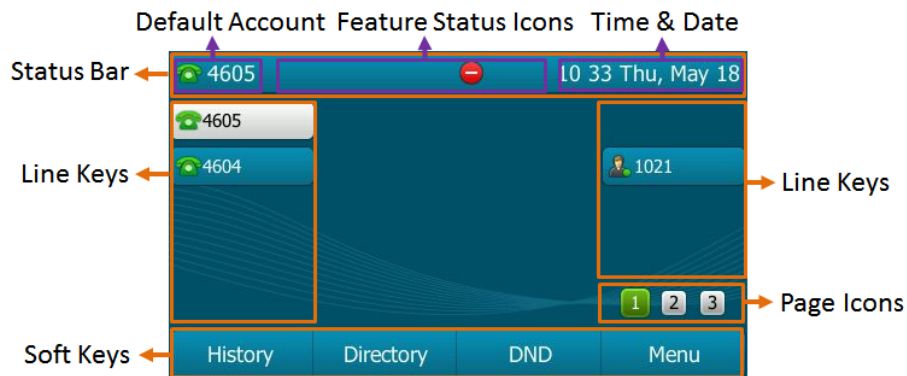

**T29G**

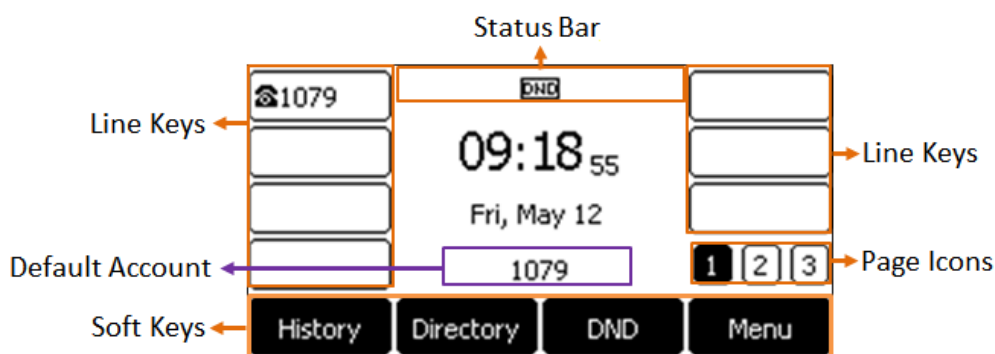

### T27G

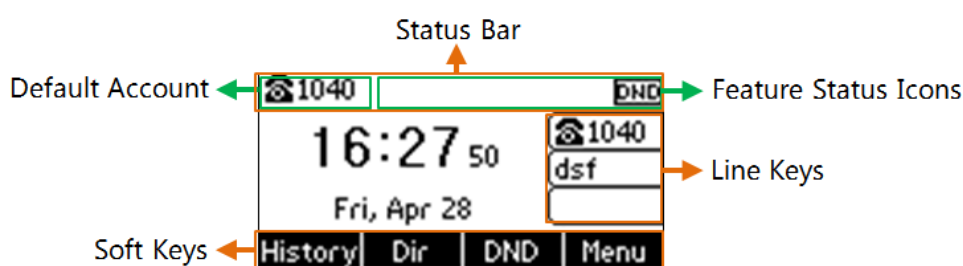

### T23P/T23G

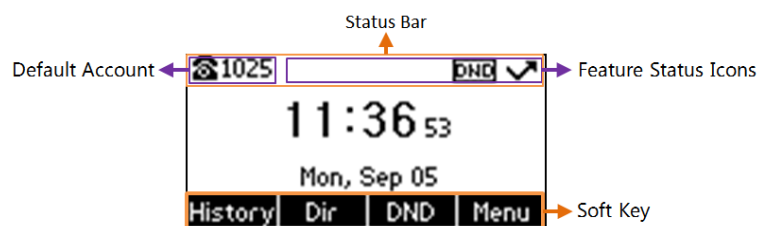

### T19(P) E2

- **Status Bar:** Display the default account, feature status icons, and the time. The status icons are displayed when features are activated.
- **Line Keys:** Display the information associated with the line keys and feature keys on the phone.
- **Page Icons:** The page icons appear only when you assign functionality to line key located in line key 11-27 on the T29G phones or line key 9-21 on the T27G phones.
- **Soft Keys:** Each soft key label indicates the action for the soft key below the screen.

#### Related Topics

[Icons in the Status Bar](#)

[Changing the Default Account](#)

[Customizing the Soft Keys](#)

## Calls Screen

All of your active and held calls are displayed on the calls screen. You can press up or down navigation key to switch among calls.

For T27G, the calls screen can display the local name or number. Check with your system administrator to find out if this feature is available on the phone. When there is an active call and a held call, the calls screen is shown below:

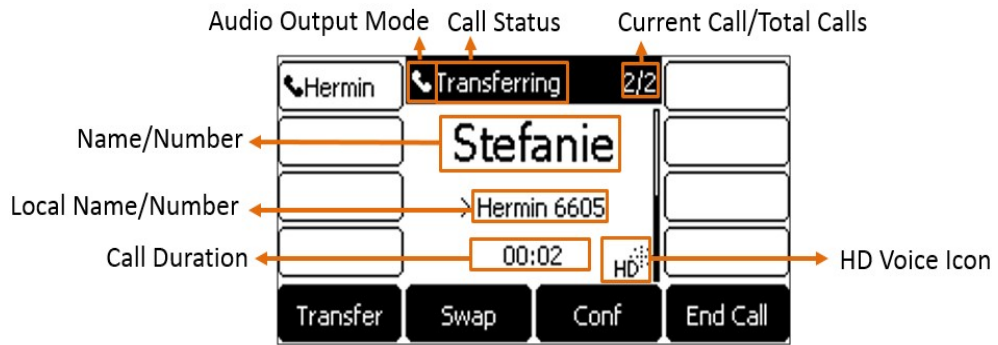

During a call, you can press the OK key to view the current time & date and phone status. The phone screen is shown below:

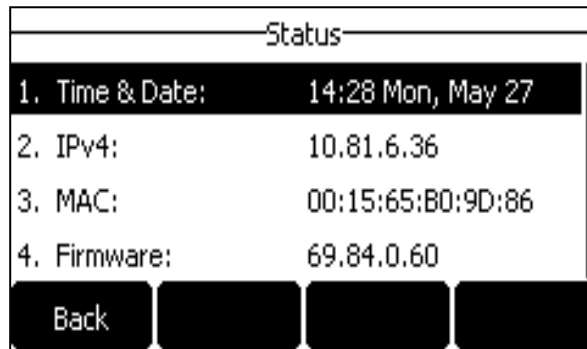

## Icons in the Status Bar

The icons in the status bar help you easily get the current phone status, such as call and message status. Icons in the status bar vary by phone models.

### Topics









[T29G Icons in the Status Bar](#)

[T27G Icons in the Status Bar](#)























[T23G/T23P/T21\(P\) E2/T19\(P\) E2 Icons in the Status Bar](#)

### T29G Icons in the Status Bar







Icons	Description	Icons	Description
	Wired network is unavailable		Phone Lock
	Wired network is unreachable		Missed Calls
	speakerphone (hands-free) mode		Call Forward
	Handset mode		Recording starts successfully (Using a USB flash drive)
	Headset mode		Recording is paused (Using a USB flash drive)
	Voice Mail		Bluetooth mode is on









Icons	Description	Icons	Description
	Text Message		Bluetooth headset is both paired and connected
	Auto Answer		Bluetooth-enabled mobile phone is both paired and connected
	Do Not Disturb (DND)		Wi-Fi connection is successful
	Keep Mute		Wi-Fi connection fails
	Ringer volume is 0		

### T27G Icons in the Status Bar

Icons	Description	Icons	Description
	Wired network is unavailable		Network is unreachable
	Speakerphone (hands-free) mode		Handset mode
	Headset mode		Voice Mail
	Text Message		Auto Answer
	Do Not Disturb (DND)		Phone Warning
	Keep Mute		Ringer volume is 0
	Phone Lock		Missed Calls
	Call Forward		Recording starts successfully (Using a USB flash drive)
	Recording is paused (Using a USB flash drive)		Wi-Fi connection is successful
	Bluetooth mode is on		Wi-Fi connection fails
	Bluetooth headset is both paired and connected		Wi-Fi connection is unreachable

### T23G/T23P/T21(P) E2/T19(P) E2 Icons in the Status Bar

Icons	Description	Icons	Description
	Wired network is unavailable		Do Not Disturb (DND)
	Wired network is unreachable		Phone Warning
	Speakerphone (hands-free) mode		Keep Mute

Icons	Description	Icons	Description
	Handset mode		Ringer volume is 0
	Headset mode		Phone Lock
	Voice Mail		Missed Calls
	Text Message		Call Forward
	Auto Answer		

## Line Key Icons

By viewing the line key icons, you can easily get the function of the line key. Icons in the line keys vary by phone models.

### Topics







[T29G Line Key Icons](#)

[T27G Line Key Icons](#)



















[T23G/T23P/T21\(P\) E2 Line Key Icons](#)

## T29G Line Key Icons

**Icon indicators** (associated with line)







Icons	Description	Icons	Description
	The private line is registered successfully.		The shared/bridged line is registered successfully.
	Register failed.		Registering.
	DND is enabled on this line.		Call forward is enabled on this line.

**Icon indicators** (associated with line key features)

Icons	Description	Icons	Description
	Hold		DND
	Voice Mail		SMS
	Direct Pickup		Group Pickup
	Conference		Forward
	Transfer		ReCall
	Record		Recording starts successfully
	Multicast Paging		Hot Desking
	Paging List		Directory
	Phone Lock		
	Speed Dial		







## T27G Line Key Icons

Icon indicators (associated with line)

Icons	Description	Icons	Description
	The private line is registered successfully.		The shared/bridged line is registered successfully.
	Register failed.		Registering.
	DND is enabled on this line.		Call forward is enabled on this line.

## T23G/T23P/T21(P) E2 Line Key Icons



Icon indicators (associated with line)

Icons	Description	Icons	Description
	The private line is registered successfully.		The shared/bridged line is registered successfully.
	Register failed.		Registering.
	DND is enabled on this line.		Call forward is enabled on this line.

## Entering Characters

You can use the keypad keys on your phone to enter or update field information.

The following table describes how to enter different characters using the keypad keys.

Task	Action
Switch input modes	Press the <b>ABC</b> , <b>abc</b> , <b>Abc</b> , <b>2aB</b> , or <b>123</b> soft key to switch the input modes.
Enter alphas	Select <b>ABC</b> , <b>abc</b> , <b>2aB</b> , or <b>Abc</b> mode. On the T27G/T23(P) E2/T19(P) E2 phones, press the keys labeled with letters until your desired letter appears. On the T29G phones, press a keypad key repeatedly to view the character options and stop when the letter you want to enter is displayed in the field. Wait one second, and then enter the next letter.
Enter numbers	Select <b>123</b> mode, press the corresponding keys.
Enter special characters	Select <b>ABC</b> , <b>abc</b> , <b>2aB</b> , or <b>Abc</b> mode, press * key or # key one or more times to enter one of the following special characters: <b>* key:</b> *,'?! \ - ( ) @ / : ; + & % = < > £ \$ ¥ ¢ [ ] { } ~ ^ _ ¡ ¢ \$ # "   <b># key:</b> # In <b>123</b> mode, you can press the * key to choose the following special characters: .*/@[].
Insert space	Select <b>ABC</b> , <b>abc</b> , <b>2aB</b> , or <b>Abc</b> mode, press the <b>0</b> key.
Move cursor	Press  or  to position the cursor.
Delete one or more characters	Position the cursor to the right of the character, and select the <b>Delete</b> soft key.

## Call Features

You can use the phone to place and answer calls, ignore incoming calls, transfer a call to someone else, conduct a conference call and perform other basic call features.

### Topics

[Changing the Default Account](#)  
[Placing Calls](#)  
[Answering Calls](#)  
[Switching Among the Handset, Speakerphone and Headset Modes](#)  
[Disabling Call Waiting](#)  
[Silencing or Rejecting Incoming Calls](#)  
[Ending Calls](#)  
[Redialing a Call Automatically](#)  
[Muting/Unmuting Audio](#)  
[Keep Mute](#)  
[Holding and Resuming Calls](#)  
[Redirecting Incoming Calls](#)  
[Transferring Calls](#)  
[Conference Calls](#)  
[Recording Using a USB Flash Drive](#)  
[Multicast Paging](#)

## Changing the Default Account

If there are multiple registered accounts on the phone, you can place a call with the default account by default. For T29G phones, you can change it manually.

It is not available on the T19(P) E2 phones.

### Procedure

1. Navigate to **Menu > Features > Others > Default Account**.
2. Select the desired account from the **Default Account** field.
3. Select **Save**.

### Tips

From the idle screen, you can press the left or right navigation key to change the default account.

## Placing Calls

You can use your phone like a regular phone to place calls in many ways easily.

### Topics

[Placing a Call from the Dialer](#)  
[Placing Multiple Calls](#)  
[Placing a Call with a Speed Dial Key](#)  
[Placing a Call Back to the Last Incoming Number](#)  
[Redialing a Number](#)  
[Dialing a Hotline Number](#)  
[Placing an International Call](#)

- [Placing a Call from the Call History](#)
- [Placing a Call from the Directory](#)
- [Placing Calls to Google Contacts](#)
- [Placing an Anonymous Call](#)
- [Placing an Emergency Call from a Locked Phone](#)

## Placing a Call from the Dialer

The Dialer enables you to enter a number to place a call, and it displays a list of previously placed calls or contacts in your directory.

You can also select the desired contact from the search list, the placed call list or Directory.

### Note

Your system administrator can configure the source list for searching and disable to display the placed call records.

### Procedure

1. Do one of the following:
  - Start typing a phone number.
  - Select the desired line key (not supported on the T19(P) E2 phones).
  - Pick up the handset, press the Speakerphone key  or the HEADSET key.
2. Enter a number or select a contact.
3. Select **Send**.

### Note

Your system administrator can enable live dialpad feature, which enables your phone to automatically dial out the phone number after a period of time without selecting **Send**.

### Related Topic

[Switching Among the Handset, Speakerphone and Headset Modes](#)

## Placing Multiple Calls

When you are in a call, you can hold your current call and place a new call.

### Procedure

1. Do one of the following:
  - Select a line key (not supported on the T19(P) E2 phones). The active call is placed on hold.
  - Press the HOLD key or **Hold** to place the original call on hold.  
Select **New Call (NewCall)**.
2. Enter the desired number or select a contact.
3. Select **Send**.

## Placing a Call with a Speed Dial Key

You can quickly dial a number by using a Speed Dial key.

### Before You Begin

If your system administrator has enabled the Favorites feature on the phone, you cannot manually set a Speed Dial key.

If you are using the T19(P) E2 phones, contact your system administrator for assistance setting a Speed Dial key for you.



**Procedure**

1. Navigate to **Menu > Features > Dsskey**.
2. Select the desired line key.
3. Select **SpeedDial** from the **Type** field.
4. Select the desired line from the **Account ID** field.
5. Do one of the following:
  - (Optional.) Enter the string that will appear on the phone screen in the **Label** field.  
Enter the contact number you want to dial out directly in the **Value** field.  
You can also enter the contact number with the DTMF sequence that you want to send in the **Value** field. The contact number and DTMF sequence are separated by commas. One comma stands for 500 milliseconds. For example, **1234,,123#** means the phone dials out the number 1234 first, then after the call is set up for 1 second, it sends the DTMF sequence 123# to the remote party.
  - On the T29G phones, highlight the **Label** or **Value** field. Press **Directory (Dir)** and select a desired contact from the Directory list.
6. Select **Save**.

**Tip**

By default, you can long press the desired line key to set it.

When the phone is idle, you can press the Speed Dial key to call a contact quickly. The phone calls a contact using the configured line by default. If you want to call a contact using another line, you can first press the line key, and then press the Speed Dial key.

**Note**

During a call, you can press the Speed Dial key to select a transfer mode. Check with your system administrator to find out if this feature is available on the phone.

## Placing a Call Back to the Last Incoming Number

You can redial the last incoming number quickly by using a Recall key.

**Before You Begin**

If you are using the T19(P) E2 phones, contact your system administrator for assistance setting a Recall key for you.

**Procedure**

1. Navigate to **Menu > Features > Dsskey**.
2. Select the desired line key.
3. Select **Key Event** from the **Type** field.
4. Select **Recall** from the **Key Type** field.
5. (Optional.) Enter the string that will appear on the phone screen in the **Label** field.
6. Select **Save**.

**Tip**

By default, you can long press the desired line key to set it.

When the phone is idle, press the Recall key to quickly redial the last incoming number.

## Redialing a Number

The phone keeps a record of all the placed calls. You can recall the contact you recently called.

### Procedure

1. Press the RD key.  
*A record of **Placed Calls** is displayed on the phone screen.*
2. Highlight the desired record, select **Send**.

### Tip

Press the RD key twice to recall the contact you called.

## Dialing a Hotline Number

When the phone is off-hook, it will dial out the hotline number automatically after the designated delay time.

### Procedure

1. Navigate to **Menu > Features > Hot Line**.  
On the T29G phones, navigate to **Menu > Features > Others > Hot Line**.
2. Do one of the following:
  - Enter the desired number in the **Hotline Number** field.
  - Press **Directory (Dir)** and select a desired contact from the Directory list.
3. Enter the desired delay time (0-10 seconds) in the **Hotline Delay** field.
4. Select **Save**.

## Placing an International Call

You can place calls to international phone numbers on your phone.

### Procedure

1. Long press digit key 0 on the phone keypad until the **plus sign (+)** appears.
2. Enter the phone number with the country code.
3. Select **Send**.

## Placing a Call from the Call History

You can place calls to contacts from the History list, which contains the calls that were recently placed, answered, missed, or forwarded.

### Procedure

1. Press **History** or navigate to **Menu > History**.  
*The phone screen displays all call records.*
2. Select the desired call list.
3. Highlight a contact and select **Send**.

## Placing a Call from the Directory

You can place a call to a contact directly from your directory.

### Procedure

1. Select **Directory (Dir)** or navigate to **Menu > Directory > Local Directory**.
2. Select the desired contact group or **All Contacts**.
3. Highlight the desired contact and select **Send**.  
If the selected contact has multiple numbers, highlight the desired number, and select **Send**.

**Related Topic**

[Searching for Contacts](#)

**Placing an Anonymous Call**

You can hide your name and number when you place a call. As a result, the callee receives an anonymous call without caller identity.

**Before You Begin**

Contact with your system administrator to find out if this feature is available on your phone, and to get the anonymous call on code or off code if required.

**Procedure**

1. Navigate to **Menu > Features > Anonymous Call (Anonymous)**.
2. Select the desired line from the **Line ID** field (not supported on the T19(P) E2 phones).  
On the T29G phones, select the desired line.
3. Select **Enabled** from the **Local Anonymous** field.
4. (Optional.) Select the desired value from the **Send Anony Code (Send Anonymous Code)** field.
5. (Optional.) Enter the anonymous call on code and off code respectively.
6. Select **Save**.
7. Select the anonymous line to place a call.

*The callee is prompted with an incoming call from anonymity.*

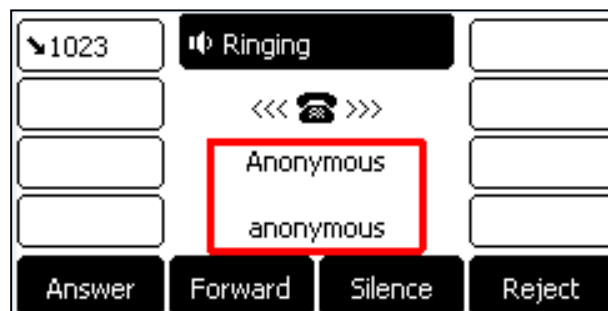

*If the callee enables anonymous rejection feature, you may be prompted that the callee does not accept calls from an anonymous number.*

**Related Topic**

[Rejecting Anonymous Calls](#)

## Placing Calls to Google Contacts

You can call your Google Contacts from your phone.

### Procedure

1. Navigate to **Menu > Directory > Google Contact**.
2. Highlight the desired contact and select **Send**.

## Placing an Emergency Call from a Locked Phone

Once all keys are locked on the phone, you can only dial emergency numbers or authorized numbers that are set up by your administrator, such as 911.

### Procedure

1. Do one of the following:
  - Select **Emergency**.

*The phone screen is shown below:*

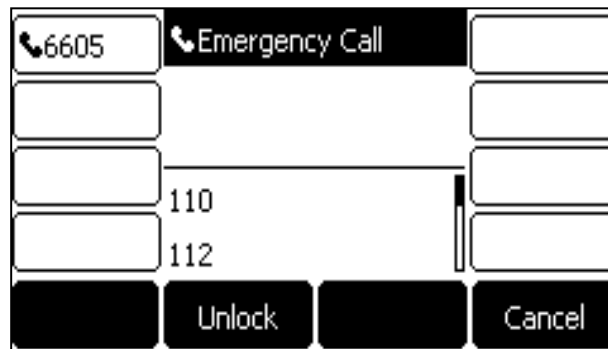

Select an emergency number in the emergency number list.

- Enter an emergency number.
2. Select **Send**.

## Answering Calls

When you receive a call, you can choose to answer it manually or automatically.

### Topics

[Answering a Call](#)

[Answering a Call When in a Call](#)

[Answering a Call Automatically](#)

## Answering a Call

When you receive an incoming call, the phone rings and the screen displays the information of the incoming call. You can choose to answer the incoming call.

### Procedure

1. Do one of the following:
  - Pick up the handset.
  - Press the Speakerphone key .

- Press the HEADSET key.
- Press **Answer** or the line key that has the flashing green LED indicator.  
*The call is answered in the speakerphone (hands-free) mode by default.*

#### Related Topic

[Switching Among the Handset, Speakerphone and Headset Modes](#)

## Answering a Call When in a Call

You can answer a call when there is already an active call on your phone.

When you are in an active call and an incoming call arrives on the phone, a call waiting tone beeps, and the incoming call information is displayed.



#### Procedure

1. Select **Answer**.

*The active call is placed on hold, and the incoming call becomes active.*

#### Note

You can disable the call waiting feature to reject the incoming call automatically during a call.

#### Related Topic

[Disabling Call Waiting](#)

## Answering a Call Automatically

Auto answer enables you to automatically answer an incoming call in speakerphone (hands-free) mode when your phone is idle.

#### Note

When you are in an active call and an incoming call arrives on the phone, the incoming call will not be automatically answered even if the auto answer is enabled.

Your system administrator can configure the phone to automatically answer the incoming call after ending all calls.

#### Procedure

1. Navigate to **Menu > Features > Auto Answer**.
2. Select the desired line (not supported on the T19(P) E2 phones).
3. Enable the **Auto Answer**.
4. Enable the **Auto Answer Mute**.
5. Select **Save**.

If the auto answer feature is enabled for the default account, the auto answer icon appears on the phone screen.

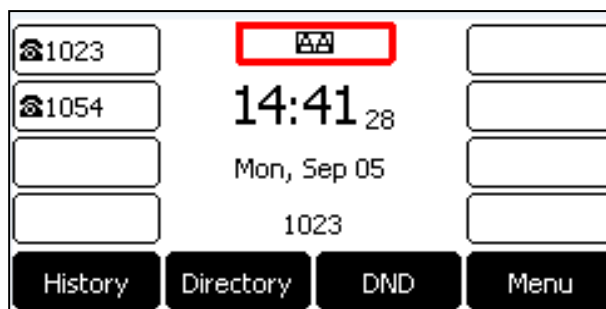

## Switching Among the Handset, Speakerphone and Headset Modes

You can select the desired mode before placing a call or can alternate among Speakerphone, headset, and handset modes during a call.

When using the headset, the LED indicator glows green. The T29G/T27G phones do not have key light.

### Procedure

1. During the call, pick up the handset, press the Speakerphone key , or press the HEADSET key.

For example, if you're using the handset, press the HEADSET key to switch to the headset, or press the Speakerphone key  to switch to the speakerphone.

### Note

Your system administrator can disable you to use the handset, speakerphone (Hands-free) or headset mode.

### Related Topic

[Headset](#)

## Disabling Call Waiting

If the call waiting feature is disabled, when there is already a call, the new incoming call will be rejected automatically.

### Before You Begin

Check with your system administrator if the call waiting off code is required. If required, get it from your system administrator.

### Procedure

1. Navigate to **Menu > Features > Call Waiting**.
2. Select **Disabled** from the **Call Waiting** field.
3. (Optional.) Enter the call waiting off code respectively in the **Off Code** field.
4. Select **Save**.

## Silencing or Rejecting Incoming Calls

When you receive an incoming call, you can choose to silence or reject the call instead of answering.

### Topics

- [Silencing a Call](#)
- [Rejecting a Call Manually](#)
- [Rejecting Anonymous Calls](#)
- [Rejecting Calls with Do Not Disturb \(DND\)](#)

## Silencing a Call

You can silence a call to stop your phone from ringing. Even if you silence the call, the incoming call notification continues to be displayed on your phone.

### Procedure

1. Select **Silence**.

## Rejecting a Call Manually

You can reject a call manually, and the call may be sent to voice mail. The rejected calls are displayed in the Received Calls list in your History list.

### Procedure

1. Select **Reject**.

## Rejecting Anonymous Calls

You can reject incoming calls from the callers who have hidden their identities. As a result, your phone will not ring and you will not be notified of an attempted call.

### Before You Begin

Check with your system administrator if the anonymous call rejection on code or off code is required. If required, get it from your system administrator.

### Procedure

1. Navigate to **Menu > Features > Anonymous Call (Anonymous.)**.  
On the T29G phones, navigate to **Menu > Features > Anonymous**.
2. Select the desired line from the **Line ID** field (not supported on the T19(P) E2 IP phones).  
On the T29G phones, select the desired line.
3. Select **Enabled** from the **Local Anony Reject (Local Anonymous Rejection)** field.
4. (Optional.) Select the desired value from the **Send Rejection Code** field.
5. (Optional.) Enter the anonymous call rejection on code and off code respectively in the **On Code** and **Off Code** field.
6. Select **Save**.

### Related Topic

[Placing an Anonymous Call](#)

## Rejecting Calls with Do Not Disturb (DND)

You can enable DND to reject all incoming calls automatically when you do not want to be interrupted.

If you want to receive incoming calls from the specific numbers when DND is enabled, you can ask your system administrator to set DND Authorized Numbers.

**Note**

Check with your system administrator to find out if the DND feature is available on your phone.

**Topics**

- [Rejecting Calls with DND on All Lines](#)
- [Rejecting Calls with DND on a Specific Line](#)
- [Deactivating DND](#)

**Rejecting Calls with DND on All Lines**

If there are multiple lines on the phone, you can enable DND for all lines. After activating it, the phone will reject all incoming calls automatically.

**Note**

If both DND and busy forward are activated on the phone, calls will be forwarded to the configured destination number.

**Before You Begin**

Check with your system administrator if the DND on code or off code is required. If required, get it from your system administrator.

**Procedure**

1. Navigate to **Menu > Features > DND**.
2. Select **On** from the **DND Status** field.
3. (Optional.) Enter the DND on code or off code respectively in the **On Code** or **Off Code** field.
4. Select **Save**.

*The DND icon appears in the status bar.*

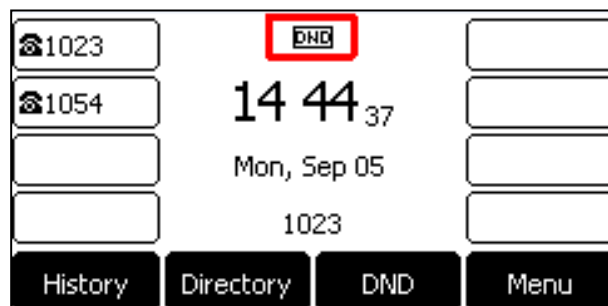

**Tip**

To activate or deactivate DND quickly, press the **DND** soft key when the phone is idle.

**Related Topics**

- [Deactivating DND](#)
- [Redirecting Incoming Calls](#)

**Rejecting Calls with DND on a Specific Line**

By default, the DND feature applies to all lines on your phone. Your system administrator can change the DND mode to Custom so that you can enable DND for specific lines. This feature is not available on the T19(P) E2 phones.

**Before You Begin**



The DND mode is set to Custom. Check with your system administrator if the DND on code or off code is required. If required, get it from your system administrator.

#### Procedure

1. Navigate to **Menu > Features > DND**.
2. Select the desired line.
3. Select **Enabled** from the **DND Account** field.
4. (Optional.) Enter the DND on code or off code respectively in the **On Code** or **Off Code** field.
5. Select **Save**.

*The DND icon appears on the desired line.*

*If you activate DND on the default line, the DND icon will appear both on the line and in the status bar.*

#### Tip

You can press the **All On** soft key to activate DND for all lines.

#### Related Topics

[Deactivating DND](#)

[Line Key Icons](#)

## Deactivating DND

You can deactivate DND when you are ready to resume receiving calls again.

#### Procedure

1. Navigate to **Menu > Features > DND**.
2. (Optional.) If the DND is activated on a specific line, select the desired line.
3. Set **DND Status** or **DND Account** to **Off** or **Disabled**.
4. Select **Save**.

*The DND icon disappears from the status bar.*

#### Tip

To deactivate DND quickly, press the **DND** soft key when the phone is idle.

You can press the **All Off** soft key to deactivate DND for all lines.

## Ending Calls

You can end the current call at any time.

#### Procedure

1. Do one of the following:
  - If you are using the handset, press the Cancel key, **End Call (EndCall)** or hang up the handset.
  - If you are using the headset, press the Cancel key or **End Call (EndCall)**.
  - If you are using the speakerphone, press the Cancel key, Speakerphone key  or **End Call (EndCall)**.

#### Tip

You can press the HEADSET key to end calls. Check with your system administrator to find out if it is available on your phone.

## Redialing a Call Automatically

You can set the phone to redial a phone number automatically when you call a contact and the contact's line is unavailable.

### Procedure

1. Navigate to **Menu > Features > Auto Redial**.  
On the T29G phones, navigate to **Menu > Features > Others > Auto Redial**.
2. Select **Enabled** from the **Auto Redial** field.
3. Enter the desired time (between 1 and 300 seconds) in the **Redial Interval** field.
4. Enter the desired times (between 1 and 300) in the **Redial Times** field.
5. Select **Save**.

When you dial a number but fail to establish a call, the phone prompts whether to auto redial the contact, select **OK** to activate auto redial.



The phone screen displays the redial times and interval. The phone will retry as many times as configured until the callee answers the call.



## Muting/Unmuting Audio

When you are in a call, you can mute the audio, so that you can hear the other person, but they cannot hear you.

### Procedure

1. Press the MUTE key during a call.  
On the T23G/T23P/T21(P) E2 phones, press the Cancel key.
2. Press the MUTE key again to unmute the call.  
On the T23G/T23P/T21(P) E2 phones, press the Cancel key again.

### Tip

You can also mute the microphone while the phone is dialing or ringing so that the other party cannot hear you when the

**Tip**

call is set up.

It is available on the T23P/T23G/T21(P) E2 phone only when the keep mute feature is enabled by your system administrator.

## Keep Mute

In a meeting room, if incoming calls are answered automatically on your phone, callers may hear your discussion with your colleagues. You can keep the phone in mute to prevent this unintended situation.

The mute state of your phone persists across calls. The phone stays in the mute state until you unmute the microphone manually or until the phone restarts.

### Before You Begin

Check with your system administrator if keep mute is configured on your phone.

### Procedure

1. Press the MUTE key when the phone is idle.

*The mute icon appears on the idle screen.*

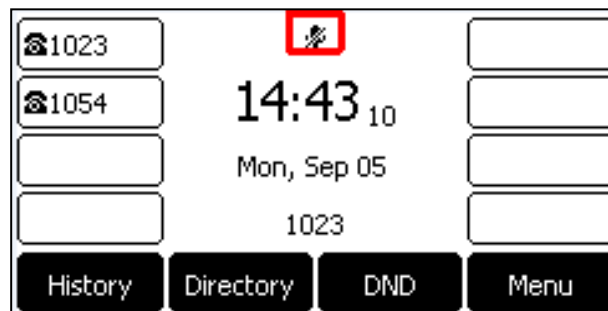

2. Press the MUTE key again to deactivate the mute state.

## Holding and Resuming Calls

You can place an active call on hold and resume the call when you are ready. When you place a call on hold, the held party may hear the music played by its sever.

### Topics

[Holding a Call](#)

[Resuming a Held Call](#)

## Holding a Call

You can place an active call on hold on your phone.

### Procedure

1. Press the HOLD key or **Hold** during a call.



The phone ignores engaged audio device (handset or headset) and plays beep in the Speakerphone (hands-free) mode by default.

#### Note

When you have multiple calls on the phone and the current call is held, you can press the corresponding line key to swap to the active call.

## Resuming a Held Call

You can view and resume a held call on the phone.

#### Procedure

1. Press the HOLD key again, corresponding line key or **Resume**.  
If multiple calls are placed on hold, select the desired call first.

#### Note

When you have multiple calls on the phone and the current call is active, you can select **Swap** to swap to the held call.

## Redirecting Incoming Calls

When you are not available to answer calls on your phone, you can forward the calls to another phone.

#### Topics

- [Forwarding All Incoming Calls to a Contact](#)
- [Forwarding an Incoming Call Manually](#)
- [Forwarding Incoming Calls with a Forward Key](#)
- [Diverting Calls to a Contact](#)

## Forwarding All Incoming Calls to a Contact

You can set up the forwarding type which enables your phone to forward all incoming calls to a contact.

There are three types of forwarding:

- **Always Forward:** Forwards all incoming calls immediately.
- **Busy Forward:** Forwards incoming calls when you are busy in a call.
- **No Answer Forward:** Forwards incoming calls when no one answers the calls.

#### Topics

- [Forwarding All Incoming Calls on All Lines](#)
- [Forwarding All Incoming Calls on a Specific Line](#)
- [Deactivating Call Forward](#)

## Forwarding All Incoming Calls on All Lines

You can forward all incoming calls on the phone.

### Before You Begin

Check with your system administrator if the forward on code or off code is required. If required, get it from your system administrator.

### Procedure

1. Navigate to **Menu > Features > Call Forward**.
2. Select the desired forwarding type and select **Enabled** from the corresponding field.
3. Do one of the following:
  - Enter the contact number you want to forward incoming calls to in the **Forward to** field.
  - On the T29G phones, highlight the **Forward to** field. Press **Directory (Dir)**, and select the desired contact from the Directory list.
4. If you select the **No Answer Forward** option, select the desired ring time to wait before forwarding from the **After Ring Time** field.
5. (Optional.) Enter the always/busy/no answer forward on code or off code respectively in the **On Code** or **Off Code** field.
6. Select **Save**.

*The call forward icon appears in the status bar.*

## Forwarding All Incoming Calls on a Specific Line

By default, the forwarding setting applies to all lines on your phone. Your system administrator can change the forward mode to Custom so that you can forward all incoming calls for specific lines. It is not available on the T19(P) E2 phones.

### Before You Begin

Check with your system administrator if the forward on code or off code is required. If required, get the forward on code or off code from your system administrator.

### Procedure

1. Navigate to **Menu > Features > Call Forward**.
2. Select the desired line.
3. Select the desired forwarding type and select **Enabled** from the corresponding field.
4. Do one of the following:
  - Enter the contact number you want to forward incoming calls to in the **Forward to** field.
  - On the T29G phones, highlight the **Label** or **Value** field. Press **Directory (Dir)** and select a desired contact from the Directory list.
5. If you select the **No Answer Forward** option, select the desired ring time to wait before forwarding from the **After Ring Time** field.
6. (Optional.) Enter the always/busy/no answer forward on code or off code respectively in the **On Code** or **Off Code** field.
7. Select **Save**.

*The forward icon appears on the desired line.*

*If you activate forward on the default line, the forward icon will appear both on the line and in the status bar.*

### Tip

You can press the **All Lines** soft key to activate forward for all lines.

## Deactivating Call Forward

You can deactivate call forward when you no longer want to forward your calls.

### Procedure

1. Navigate to **Menu > Features > Call Forward**.
2. (Optional.) If the forward is activated for a specific line, select the desired line.
3. Select the desired forwarding type and select **Disabled** from the corresponding field.
4. Select **Save**.

### Tip

For , you can tap **Close forward**. to deactivate DND quickly when the phone is idle. You can press the **All Lines** soft key to deactivate forward for all lines.

## Forwarding an Incoming Call Manually

You can manually forward the call to another contact while your phone rings.

### Procedure

1. When the phone is ringing, select **Forward**.
2. Enter the number you want to forward the incoming call to.
3. Press the OK key or **Send**.

*The phone prompts a call forward message.*

## Forwarding Incoming Calls with a Forward Key

When the phone receives an incoming call, you can easily press the Forward key to forward the incoming call to a specific contact.

### Before You Begin

If you are using the T19(P) E2 phones, check with your system administrator if the Forward key has set for your phone.

### Procedure

1. Navigate to **Menu > Features > Dsskey**.
2. Select the desired line key.
3. Select **Key Event** from the **Type** field.
4. Select **Forward (FWD)** from the **Key Type** field.
5. If your system administrator has set the forward mode to **Custom**, select the desired line from the **Account ID** field.
6. Do one of the following:
  - (Optional.) Enter the string that will display on the phone screen in the **Label** field.  
Enter the contact number you want to forward the incoming calls to in the **Value** field.
  - On the T29G phones, highlight the **Label** or **Value** field. Press **Directory (Dir)** and select a desired contact from the Directory list.
7. Select **Save**.

### Tip

By default, you can long press the desired line key to set it.

When the phone is ringing, press the forward key to quickly forward the call to the specific contact.

## Diverting Calls to a Contact

You can divert all incoming calls from a particular contact to another contact. Auto divert has precedence over call forward.

### Procedure

1. Select **Directory (Dir)** or navigate to **Menu > Directory > Local Directory**.
2. Select the desired contact group or **All Contacts**.
3. Highlight the desired contact, and select **Option > Detail**.
4. Edit the contact information.
5. Enter a contact's number you want to divert the call to in the **Auto Divert** field.
6. Select **Save**.

## Transferring Calls

During a call, you can transfer the call to another contact.

You can use one of three ways:

- **Blind Transfer:** Transfer a call directly to the third party without consulting.
- **Semi-Attended Transfer:** Transfer a call when receiving ringback.
- **Attended Transfer (Consultative Transfer):** Transfer a call with prior consulting.

### Topics

[Performing a Blind Transfer](#)

[Performing a Semi-Attended/Attended Transfer](#)

[Performing Transfer with a Transfer Key](#)

## Performing a Blind Transfer

You can transfer a call to another contact immediately without consulting with her/him first.

### Procedure

1. Press the TRAN key or **Transfer (Trans)** during a call.
2. Do one of the following:
  - Enter the number or select a contact from the placed call list you want to transfer to.
  - If you have set a Speed Dial key, you can also press the Speed Dial key to transfer the call to the contact directly.
  - Press **Directory (Dir)**. Select the desired contact from the Directory list.
3. Press **B Transfer (B Trans)** or the TRAN key to complete the transfer.

### Tip

If you are using a handset, the transfer can be completed by hanging up the handset.

## Performing a Semi-Attended/Attended Transfer

You can transfer calls to other contacts immediately when receiving ringback or after consulting with them first.

### Procedure

1. Press the TRAN key or **Transfer (Trans)** during a call.
2. Do one of the following:
  - Enter the number or select a contact from the placed call list you want to transfer the call to.
  - Press **Directory (Dir)**. Select the desired contact from the Directory list.
3. Press the OK key or **Send**.
4. Do one of the following:
  - When you hear the ringback tone, press the TRAN key or **Transfer (Trans)** to finish a semi-attended transfer.
  - After the contact answers the call, press the TRAN key or **Transfer (Trans)** to finish an attended transfer (consultative transfer).

**Tip**

If you are using a handset, the transfer can be completed by hanging up the handset.

## Performing Transfer with a Transfer Key

By default, you can transfer a call to a specific contact directly using a Transfer key during a call.

Your system administrator can also set your phone to perform attended transfer when using a Transfer key.

### Topics

[Setting a Transfer Key](#)

[Performing a Blind Transfer Using a Transfer Key](#)

[Performing a Semi-attended/Attended Using a Transfer Key](#)

[Performing a Call Transfer by Selecting a Transfer Mode](#)

## Setting a Transfer Key

You can set a line key as a Transfer key, and specify a contact you want to transfer a call to for this key.

Line key is not available on the T19(P) E2 phones, so ask your system administrator to set a Transfer key for your phone.

### Procedure

1. Navigate to **Menu > Features > Dsskey**.
2. Select the desired line key.
3. Select **Key Event** from the **Type** field.
4. Select **Transfer (Trans)** from the **Key Type** field.
5. Do one of the following:
  - (Optional.) Enter the string that will appear on the phone screen in the **Label** field.  
Enter the contact number you want to transfer the call to in the **Value** field.
  - On the T29G phones, highlight the **Label** or **Value** field. Press **Directory (Dir)** and select a desired contact from the Directory list.
6. Select **Save**.

**Tip**

By default, you can long press the desired line key to set it.

## Performing a Blind Transfer Using a Transfer Key

After you have set a Transfer key with a specific contact, you can perform a blind transfer by using it.

If you are using the T19(P) E2 phones, check with your system administrator if the Transfer key has set for your phone.



**Before You Begin**

Confirm with your system administrator that the transfer mode has set to perform a blind transfer.

**Procedure**

1. Press the Transfer key during a call.

*The call is transferred to the specific contact directly.*

**Related Topic**

[Setting a Transfer Key](#)

**Performing a Semi-attended/Attended Using a Transfer Key**

After you have set a Transfer key with a specific contact, you can perform a semi-attended/attended transfer by using it.

If you are using the T19(P) E2 phones, check with your system administrator if the Transfer key has set for your phone.

**Before You Begin**

Confirm with your system administrator that the transfer mode has set to perform attended transfer.

**Procedure**

1. Press the Transfer key during a call.

*The phone calls the specific contact first. Wait until you hear the ringback tone or until the contact answers the call.*

2. Press the Transfer key again.

**Related Topic**

[Setting a Transfer Key](#)

**Performing a Call Transfer by Selecting a Transfer Mode**

During the call, you can press the Transfer key to select a transfer mode.

**Before You Begin**

You need to set a Transfer key for a specific contact. Check with your system administrator to find out if this call transfer feature is available on the phone.

**Procedure**

1. Press the Transfer key during a call, the phone screen is shown below:

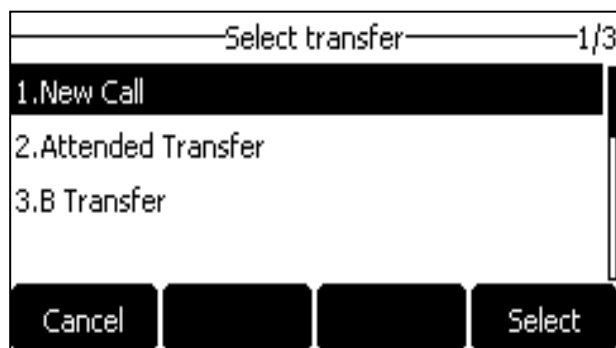

2. Select the desired transfer mode.

**Related Topic**[Setting a Transfer Key](#)

## Conference Calls

The phone supports a three-way local conference and multi-way network conference.

During the conference, follow these tips:

- Use the handset or a headset if you're in an open environment.
- Mute your microphone when you are not speaking, especially in noisy environments.
- Avoid tapping or rustling papers near the microphone.
- Speak in your normal voice without shouting.

**Topics**[Local Conference](#)[Network Conference](#)

## Local Conference

You can initiate a three-way (including yourself) conference calls with your contacts on the phone.

**Note**

Check with your system administrator to find out if the local conference is enabled on your phone.

**Topics**[Setting Up a Local Conference Call](#)[Merging Two Calls into a Conference](#)[Inviting a Transfer Target and a Transferee into a Conference](#)[Holding or Resuming a Conference Call](#)[Muting or Unmuting a Conference Call](#)[Splitting a Conference Call](#)[Managing Conference Participants](#)[Ending a Conference Call](#)

## Setting Up a Local Conference Call

You can set up a local conference call with up to two contacts.

**Procedure**

1. Place a call to the first party.
2. When the first party answers the call, select **Conference (Conf)** to place a new call.  
On the T29G/T27G phones, you can also press the CONF key.  
*The active call is placed on hold.*
3. Dial the second party's number.  
You can also select the desired contact from the search list, or select a contact from the placed call list or Directory before you enter the number.
4. When the second party answers the call, select **Conference (Conf)** to invite two parties to join the conference.  
On the T29G/T27G phones, you can also press the CONF key.



## Merging Two Calls into a Conference

You can invite a held call into a conference call with the active call.

### Procedure

1. Place two calls on the phone.
2. Select the desired call for a conference and ensure that the call is active.
3. Select **Conference (Conf)**.
4. Highlight the desired hold call and select **Send**.

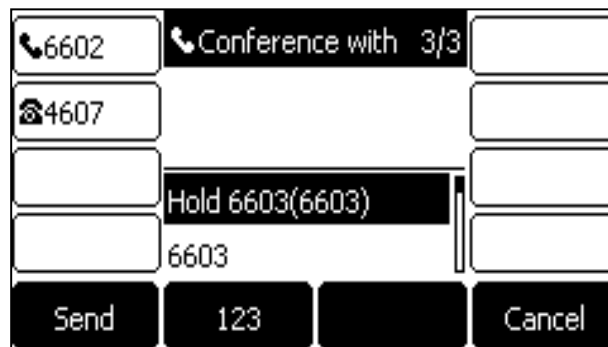

*The active call and the selected hold call are joined into a conference.*

## Inviting a Transfer Target and a Transferee into a Conference

After consulting with the contact you want to transfer a call to, you can invite the two calls into a conference.

### Procedure

1. Select **Conference (Conf)** after talking with the contact you want to transfer a call to.  
On the T29G/T27G phones, you can also press the CONF key.

*The transferee and the transfer target join the conference.*

## Holding or Resuming a Conference Call

When you place a conference call on hold, other participants cannot hear each other until you resume the held conference call.

### Procedure

1. Press the HOLD key or **Hold** to place the conference on hold.
2. Press the HOLD key again or **Resume** to resume the held conference call.

## Muting or Unmuting a Conference Call

When you mute the local microphone during a conference call, other participants can hear each other except you.

### Procedure

1. Press the MUTE key to mute the conference.  
On the T23G/T23P/T21(P) E2 phones, press the Cancel key.
2. Press the MUTE key again to unmute the conference.  
On the T23G/T23P/T21(P) E2 phones, press the Cancel key again.

## Splitting a Conference Call

You can split the conference call into individual calls. After the split, the conference call ends, and other parties are held.

### Procedure

1. Select **Split**.

## Managing Conference Participants

You can manage the conference participants to make the conference more flexible.

### Procedure

1. During a conference call, select **Manage**.
2. Select the desired party, you can do the following:
  - Select **Far Mute (FarMute)** to mute the party. The muted party can hear everyone, but no one can hear the muted party.
  - Select **Far Hold (FarHold)** to hold the party. The held party cannot hear anyone, and no one can hear the held party.
  - Select **Remove** to remove the party from the conference call.

## Ending a Conference Call

When you end the conference call, the other parties drop the call.

However, the system administrator can set up your phone so that the other two parties remain connected when you end the conference call.

### Procedure

1. Select **End Call (EndCall)**.

## Network Conference

If your system administrator has set a network conference feature on your phone, you can initiate a conference with two or more contacts.

### Topic

[Setting Up a Network Conference](#)

## Setting Up a Network Conference

You can set up a network conference with two or more contacts.

### Procedure

1. Place a call to the first party.
2. Select **Conference (Conf)**.  
On the T29G/T27G phones, you can also press the CONF key.  
*The active call is placed on hold.*

3. Dial the second party's number.
4. When the second party answers the call, select **Conference (Conf)** to add the second party to the conference.  
On the T29G/T27G phones, you can also press the CONF key.
5. Select **Conference** to place a new call.  
On the T29G/T27G phones, you can also press the CONF key.  
*The conference call is placed on hold.*
6. Enter the number of the new party, and then press the OK key or **Send**.
7. When the new party answers the call, select **Conference (Conf)** to add the new party to the conference.  
On the T29G/T27G phones, you can also press the CONF key.
8. Repeat steps 5 to 7 until you add all parties.

**Note**

The procedures for setting up a network conference call on specific servers may be different. Contact your system administrator for more information.

## Recording Using a USB Flash Drive

On the T29G/T27G phones, you can record active calls onto a USB flash drive connected to your phones, and the recordings are saved as \*.wav files.

Recording using a USB flash drive is not available by default. Contact your system administrator for enabling this feature for you.

**Note**

The size of a single recording file should be less than 2G.

**Topics**

- [Recording a Call](#)
- [Pausing/Resuming a Recording](#)
- [Stopping a Recording](#)
- [Listening to a Recording](#)
- [Managing the Recordings](#)
- [Viewing the Available Recording Time](#)

## Recording a Call

You can record the important parts during an active call.

**Important**

Before call recording, especially those involving PSTN, it is necessary to know about the rules and restrictions of call recording in the country where you are.

It is also very important to inform all the call parties that you are recording and ask for their consent before recording the conversation.

**Before You Begin**

Make sure that the USB flash drive has been connected to your phone.

**Procedure**

1. During a call, select **More** (  ) > **Start REC**.

*The phone screen displays a recording icon and recording duration.*



## Pausing/Resuming a Recording

When you do not want the current sensitive information to be recorded, you can pause the recording.

After pausing, you can resume it at any time and the recording continues and will be saved in the same file.

### Procedure

1. Select **Pause REC** to pause a recording.

*The pause recording icon appears on the phone screen and the duration stops counting.*

2. Select **Resume REC** to resume a recording.

### Note

If you hold the call during the recording, none of the parties will be recorded until you resume the call.

## Stopping a Recording

You can stop recording a call before the call ends. The recording also stops when the active call ends. The recording will be saved as "\*.wav" file in the USB flash drive automatically.

### Procedure

1. Do one of the following:

- Select **Stop REC**.

*The recording icon and recording duration disappears. The screen prompts a message that the call is recorded successfully.*

- Select **End Call (EndCall)**.

*The recording icon and recording duration disappears, and the phone returns to the idle screen. The screen prompts a message that the call is recorded successfully.*

## Managing the Recordings

After stopping recording, you can manage the recordings on your phone. Make sure the USB flash drive is still inserted in the phone.

### Topics

[Listening to a Recording](#)

[Pausing/Resuming a Playback](#)

[Fast Forwarding/Rewinding a Playback](#)

[Deleting a Recorded Call](#)

## Listening to a Recording

You can browse and play back the recordings on your phone.

During the recording plays, you can switch among Speakerphone (hands-free) modes by pressing the Speakerphone key , Handset modes by pressing the HEADSET key or Handset mode by picking up the handset.

### Tip

You can also play back the recordings on a PC using an application capable of playing "\*.wav" file.

### Procedure

1. Navigate to **Menu > USB > Browse Audio**.

The phone screen shows all recorded files (filename, duration time and file size) in the **Browse Audio** list. The file-name consists of the recording time & date, the other party's number/IP address/name (or the first person's number/IP address/name you called).

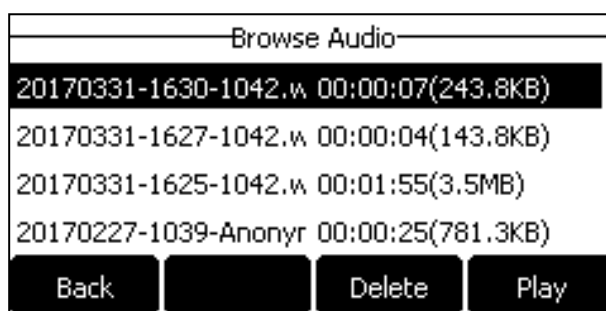

2. Highlight the desired file, and select **Play**.

The length of the recording and a progress bar are displayed as the recording plays.



### Related Topics

[Switching Among the Handset, Speakerphone and Headset Modes](#)  
[Adjusting the Volume](#)

### Pausing/Resuming a Playback

When you are playing a recording, you can pause it manually to take note.

When you receive an incoming call while playing a recording, the recording is paused automatically. You can resume the playback after handling the call.

### Procedure

1. Select **Pause** to pause the playback. The **Play** soft key appears on the phone screen.
2. Select **Play** to restart the playback.

### Fast Forwarding/Rewinding a Playback

While a recording plays, you can fast forward or rewind the playback at any time.

**Procedure**

- Select **F.Fwd** (▶▶) to skip forward the playback. Press once to skip forward 8 seconds.
- Select **F.Rew** (◀◀) to rewind the playback. Press once to rewind 8 seconds.

**Deleting a Recorded Call**

You can delete the recordings when you need additional space on your USB flash drive or the recordings are useless.

**Procedure**

1. Navigate to **Menu > USB > Browse Audio**.
2. Highlight the desired recording, and select **Delete**.  
*The phone prompts you whether to delete the audio.*
3. Select **OK**.

**Viewing the Available Recording Time**

You can view the available recording time on your phone, to avoid recording failure due to timeout.

When you insert a USB flash drive to the phone during a call, a message will pop up to tell you how much time is available for recording.

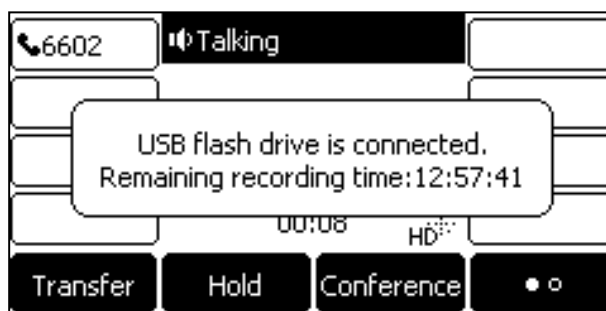

During a recording, if there is insufficient free space (30 minutes or 10 minutes left) on the USB flash drive, the phone will prompt you a message (XX minutes left for call recording). If no free space on the USB flash drive during recording, the recording is stopped and saved in the USB flash drive automatically.

You can also view the storage space of the USB flash drive, and check the available recording time before recording.

**Procedure**

1. Navigate to **Menu > USB > Storage Space**.

**Multicast Paging**

Multicast Paging allows you to broadcast instant audio announcements to users who are listening to a specific multicast group on a specific channel.

The phone supports the following 31 channels:

- **0**: Broadcasts are sent to channel 0. Note that the Yealink IP phones running firmware version 80 or earlier can be regarded as listening to channel 0. It is the default channel.
- **1 to 25**: Broadcasts are sent to channel 1 to 25. We recommend that you specify these channels when broadcasting with Polycom IP phones which have 25 channels you can listen to.
- **26 to 30**: Broadcasts are sent to channel 26 to 30. We recommend that you specify these channels when broadcasting with Yealink IP phones running firmware version 81 or later.



**Note**

All IP phones in the multicast paging group must be deployed in the same subnet since a broadcast is used. The phone can only send/receive broadcasts to/from the listened channels. Other channels' broadcasts will be ignored automatically by the IP phone.

**Topics**

[Sending Multicast Paging](#)  
[Receiving Multicast Paging](#)  
[Managing a Paging Call](#)

## Sending Multicast Paging

Your phone supports up to 31 groups for paging. You can assign a label to each group to identify the phones in the group, such as All, Sales, or HR.

You can set a line key as Multicast Paging key or Paging List key on the phone, which allows you to send announcements to the phones with pre-configured multicast address(es) on specific channel(s).

**Note**

Multicast RTP is one way only from the sender to the multicast address(es) (receiver). For outgoing RTP multicasts, all other existing calls on the phone will be placed on hold.

**Topics**

[Setting a Multicast Paging Key](#)  
[Setting a Paging List Key](#)  
[Sending Pages by a Paging List Key](#)  
[Setting a Paging Group](#)  
[Sending a Paging by a Multicast Paging Key](#)  
[Deleting a Paging Group](#)

## Setting a Multicast Paging Key

You can set a Multicast Paging key for a paging group, which allows you to send announcements quickly on the idle screen.

Line key is not available on the T19(P) E2 phones, so ask your system administrator to set a Multicast Paging key for your phone.

**Before You Begin**

Get the multicast IP address and port number from your system administrator.

**Procedure**

1. Navigate to **Menu > Features > Dsskey**.
2. Select the desired line key.
3. Select **Key Event** from the **Type** field.
4. Select **Multicast Paging** from the **Key Type** field.
5. (Optional.) Enter the paging group name in the **Label** field.
6. Enter the multicast IP address and port number (for example, 224.5.6.20:10008) in the **Value** field.
7. Enter the desired channel between 0 and 30 in the **Channel** field.
8. Select **Save**.

**Tip**

By default, you can long press the desired line key to set it.

## Sending a Paging by a Multicast Paging Key

You can send a paging by using the Multicast Paging key when the phone is idle.

### Before You Begin

You need to set a Multicast Paging key in advance. If you are using the T19(P) E2 phones, check with your system administrator if the Multicast Paging key has set for your phone.

### Procedure

1. Press the Multicast Paging key when the phone is idle.

*Both your phone and receiver's phone play a warning tone and the multicast RTP session will be automatically answered on the receiver's phone in the speakerphone (hands-free) mode.*

*On all IP phones except the T19(P) E2 phones, the multicast paging key LED glows green.*

*The following figure shows a multicast RTP session on the phone:*

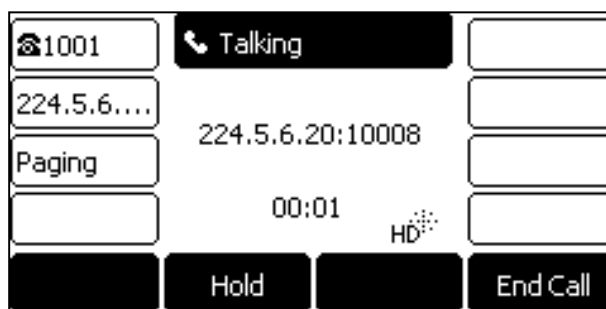

### Related Topic

[Setting a Multicast Paging Key](#)

## Setting a Paging List Key

You can set a Paging List key to easily access the paging groups on the idle screen. Line key is not available on the T19 (P) E2 phones, so ask your system administrator to set a Paging List key for your phone.

### Procedure

1. Navigate to **Menu > Features > Dsskey**.
2. Select the desired line key.
3. Select **Key Event** from the **Type** field.
4. Select **Paging List** from the **Key Type** field.
5. (Optional.) Enter the string that will display on the phone screen in the **Label** field.
6. Select **Save**.

**Tip**

By default, you can long press the desired line key to set it.

## Setting a Paging Group

You can edit the information of the paging group.

## Before You Begin

A Paging List key is set in advance. Get the multicast IP address and port number from your system administrator.

### Procedure

1. Press the Paging List key when the phone is idle.
2. Select the desired paging group.  
*The default tag is Empty if it is not configured before.*
3. Select **Option > Edit**.
4. Enter the multicast IP address and port number (for example, 224.5.6.20:10008) in the **Address** field.
5. Enter the string that will display on the phone screen in the **Label** field.
6. Enter the desired channel between 0 and 30 in the **Channel** field.
7. Select **Save**.
8. To set more paging groups, repeat steps 2 to 7.

## Sending Pages by a Paging List Key

You can send a paging by using the Paging List key when the phone is idle.

### Before You Begin

You need to set a Paging List key in advance. If you are using the T19(P) E2 phones, check with your system administrator if the Paging List key has set for your phone.

### Procedure

1. Press the Paging List key when the phone is idle.
2. Select the desired paging group.
3. Select **Paging** to send RTP.  
*Both your phone and receiver's phone play a warning tone and the multicast RTP session will be automatically answered on the receiver's phone in the speakerphone (hands-free) mode.*

### Related Topic

[Setting a Paging List Key](#)

## Deleting a Paging Group

You can delete any group from the paging group list.

### Procedure

1. Press the Paging List key when the phone is idle.  
If the Paging List key is not set, you can also navigate to **Menu > Features > Others > Paging List** for the T29G phone or **Menu > Features > Paging List** for other phones.
2. Select the desired paging group.
3. Select **Option > Delete**.  
*The phone prompts you whether to delete the paging group.*
4. Select **OK**.

## Receiving Multicast Paging

Your system administrator has set a listening paging group for you, you can automatically receive a paging call when the phone is idle.

When there is a voice call or a paging call in progress, or when DND is activated on your phone, the phone handles the new paging call differently according to the multicast listening settings configured by your system administrator.

## Managing a Paging Call

During a paging call, you can manage it manually at any time.

### Procedure

- Press **Hold** to place the current paging call on hold.  
*The paging call is placed on hold and the receiver releases the session.*
- Press **Resume** to resume the held paging call.  
*The multicast RTP session is re-established.*
- Select **End Call (EndCall)** to end the paging call.

## Advanced Call Features

You can perform some server-dependent tasks on the phone. Contact your system administrator to find out if your phone supports these advanced call features.

### Topics

[Using Call Completion](#)  
[Call Pickup](#)  
[Call Park and Call Retrieve](#)  
[Busy Lamp Field \(BLF\)](#)  
[BLF List](#)  
[Shared Line](#)  
[Intercom](#)  
[Short Message Service \(SMS\)](#)  
[Voice Mail](#)  
[Using the Hot Desking](#)  
[Automatic Call Distribution \(ACD\)](#)

## Using Call Completion

When you call someone who is temporarily unavailable to answer the call, you can monitor the busy party and establish a call after the busy party becomes available to receive a call.

### Note

Call completion is not available on all servers. For more information, contact your system administrator.

### Procedure

1. Navigate to **Menu > Features > Call Completion**.  
On the T29G phones, navigate to **Menu > Features > Others > Call Completion**.
2. Select **Enabled** or **On** in the **Call Completion** field.
3. Select **Save**.

When you place a call and the callee is temporarily unavailable to answer the call, the phone prompts whether to wait for the callee, select **OK** to activate the call completion feature.



When the callee becomes idle, the phone prompts whether to dial the number, select **OK** to dial the number.

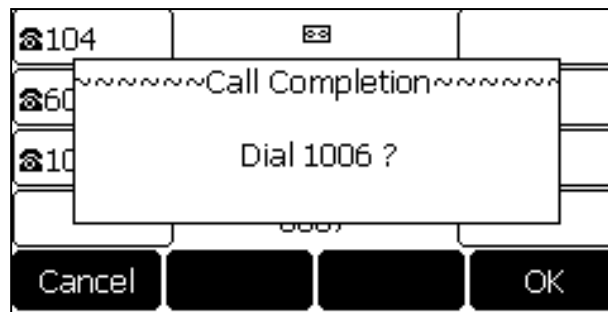

## Call Pickup

You can use call pickup to answer someone else's incoming call on your phone.

The phone supports the following two call pickup features:

- **Directed Call Pickup:** allows you to pick up incoming calls to another phone.
- **Group Call Pickup:** allows you to pick up incoming calls to any phone within a predefined group.

Check with your system administrator to find out if this feature is available on your phone.

### Topics

[Picking up a Call Directly](#)

[Picking up a Group Call Directly](#)

[Picking up a Call with a Directed Pickup Key](#)

[Picking up a Call with a Group Pickup Key](#)

## Picking up a Call Directly

You can answer a call that rings on another phone.

### Before You Begin

The target phone receives an incoming call. Your system administrator has enabled the directed call pickup and set the directed call pickup code.

### Procedure

1. Pick up the handset, press the line key or the Speakerphone key .

*The **DPickup** appears on the phone screen (You may need to select the **More**  soft key to see the **DPickup** soft key).*

2. Select **DPickup** on your phone.
3. Enter the phone number which is receiving an incoming call.
4. Select **DPickup** again.

*The call is answered on your phone.*

### Tip

When the phone is idle, you can use a Directed Pickup or BLF/BLF List key to pick up a call to a specific contact directly. BLF/BLF List key is not available on the T19(P) E2 phone.

### Related Topics

[Picking up a Call with a Directed Pickup Key](#)

[Picking up a Remote Call by BLF Key](#)

[Picking up a Remote Call by BLF List Key](#)

## Picking up a Group Call Directly

When any phone within a predefined group receives an incoming call, you can pick up that call on your phone.

If there are multiple incoming calls on the group at the same time, you can only pick up the first incoming call.

### Before You Begin

Your system administrator has enabled the group call pickup and set the group call pickup code.

### Procedure

1. Pick up the handset, press the line key or the Speakerphone key .

*The **GPickup** appears on the phone screen.*

2. Select **GPickup** on your phone when any phone in the group receives an incoming call.

*The call is answered on your phone.*

### Tip

When the phone is idle, you can use a Group Pickup key to pick up a group call directly.

### Related Topic

[Picking up a Call with a Group Pickup Key](#)

## Picking up a Call with a Directed Pickup Key

You can easily use a Directed Pickup key to pick up a call to a specific contact's phone.

### Before You Begin

Ask your system administrator for the directed call pickup code. If you are using the T19(P) E2 phones and check with your system administrator if the Directed Pickup key has set for your phone.

### Procedure

1. Navigate to **Menu > Features > Dsskey**.
2. Select the desired line key.
3. Select **Key Event** from the **Type** field.
4. Select **Pick Up** from the **Key Type** field.
5. Select the desired line from the **Account ID** field.
6. Do one of the following:
  - (Optional.) Enter the string that will display on the phone screen in the **Label** field.  
Enter the directed call pickup code followed by the specific extension in the **Value** field.
  - On the T29G phones, highlight the **Label** or **Value** field. Press **Directory (Dir)** and select a desired contact from the Directory list.
7. Select **Save**.

### Tip

By default, you can long press the desired line key to set it.

When the target phone receives an incoming call, you can press the Directed Pickup key, and the call is answered on your phone.

## Picking up a Call with a Group Pickup Key

You can easily select a Group Pickup key to pick up a group call.

### Before You Begin

Check with your system administrator if the group call pickup code is required for this key. If required, get the group call pickup code from your system administrator. If you are using the T19(P) E2 phones, check with your system administrator if the Group Pickup key has set for your phone.

### Procedure

1. Navigate to **Menu > Features > Dsskey**.
2. Select the desired line key.
3. Select **Key Event** from the **Type** field.
4. Select **Group Pick Up** from the **Key Type** field.
5. Select the desired line from the **Account ID** field.
6. Do one of the following:
  - (Optional.) Enter the string that will appear on the phone screen in the **Label** field.  
Enter group call pickup code in the **Value** field.
  - On the T29G phones, highlight the **Label** or **Value** field. Press **Directory (Dir)** and select a desired contact from the Directory list.
7. Select **Save**.

### Tip

By default, you can long press the desired line key to set it.

When any phone within a predefined group of phones receives an incoming call, you can press the Group Pickup key, and the call is answered on your phone.

## Call Park and Call Retrieve

You can park a call, and then retrieve the call either from your phone or another phone. After parked, the call is placed on hold, you can continue the conversation after retrieving it.

### Note

Call park is not available on all servers. Check with your system administrator to find out if it is available on your phone.

### Topics

[Parking or Retrieving a Call in the FAC Mode](#)

[Parking or Retrieving a Call in the Transfer Mode](#)

[Parking or Retrieving a Call with a Park or Retrieve Key](#)

## Parking or Retrieving a Call in the FAC Mode

You can park the call to the local extension or the desired extension through dialing the park code.

### Topics

[Parking a Call in the FAC Mode](#)

[Retrieving a Parked Call in the FAC Mode](#)



## Parking a Call in the FAC Mode

You can park a call in the FAC mode directly. When you park a call to the local extension or the desired extension, the call is held in the same network your phone.

### Before You Begin

Your system administrator has set call park in the FAC mode.

### Procedure

1. During a call, select **Park** (You may need to press the **More** (  ) soft key to see the **Park** soft key).

*The phone will dial the call park code which is pre-configured.*

2. Do one of the following:

- If you want to park the call against the local extension, press the # key.
- If you want to park the call against the desired extension, enter the extension (for example, 4606) where you want to park the call and press the # key.

*If the call is parked successfully, you will hear a voice prompt that the call is parked.*

### Tip

You can use a Park key or a BLF key to park a call to a specific contact directly. BLF key is not available on the T19(P) E2 phone.

### Related Topics

[Parking or Retrieving a Call with a Park or Retrieve Key](#)

[Parking or Retrieving a Call by BLF Key](#)

## Retrieving a Parked Call in the FAC Mode

You can retrieve a parked call in the FAC mode from any phone within your network.

### Before You Begin

Your system administrator has set call park in the FAC mode. There is a call parked on the extension.

### Procedure

1. Select **Retrieve** (You may need to press the **More** (  ) soft key to see the **Retrieve** soft key) on the dialing screen.

*The phone will dial the park retrieve code which is configured in advance.*

2. Follow the voice prompt to retrieve:

- Press the # key on the phone where the call is parked.
- Enter the desired extension followed by # (for example, 4606#) on any phone.

### Tip

When the phone is idle, you can use a Retrieve key or a BLF key to retrieve a parked call directly. BLF key is not available on the T19(P) E2 phone.

### Related Topics

[Parking or Retrieving a Call with a Park or Retrieve Key](#)

[Parking or Retrieving a Call by BLF Key](#)

[Retrieving a Call by a BLF List Key](#)

## Parking or Retrieving a Call in the Transfer Mode

You can park the call to the shared parking lot through a blind transfer.

For some servers, the system will return a specific retrieve park number (park retrieve code) after parking successfully.

### Topics

[Parking a Call in the Transfer Mode](#)

[Retrieving a Parked Call in the Transfer Mode](#)

## Parking a Call in the Transfer Mode

You can park a call in the transfer mode directly. When you park a call to the shared parking lot, the call is held on your phone.

### Before You Begin

Your system administrator has set call park in the Transfer mode.

### Procedure

1. During a call, select **Park** (You may need to select the **More**  soft key to see the **Park** soft key).

*The call will be directly transferred to the shared parking lot.*

### Tip

You can use a Call Park key to park a call to a specific shared parking lot directly.

### Related Topic

[Parking or Retrieving a Call with a Park or Retrieve Key](#)

## Retrieving a Parked Call in the Transfer Mode

You can retrieve a parked call in the transfer mode from any phone in the same network.

### Before You Begin

Your system administrator has set call park in the Transfer mode. There is a call parked on the shared parking lot.

### Procedure

1. Select **Retrieve** (You may need to select the **More**  soft key to see the **Retrieve** soft key) on the dialing screen.

*The phone will retrieve the parked call from the shared parking lot.*

### Tip

When the phone is idle, you can use a Retrieve key to retrieve a parked call directly.

### Related Topic

[Parking or Retrieving a Call with a Park or Retrieve Key](#)

## Parking or Retrieving a Call with a Park or Retrieve Key

You can easily use a Park key to park a call to a specific extension (if the FAC mode is set) or shared parking lot (if the Transfer mode is set), and quickly retrieve this parked call using a retrieve key. It's not available on the T19(P) E2 phone.

### Topics

[State Indicator of the Park/Retrieve key](#)





[Parking a Call using a Park Key](#)

[Retrieving a Parked Call using a Retrieve Key](#)

## State Indicator of the Park/Retrieve key

On T29G phones, you can get the call park/retrieve status by viewing the icon indicator of the Park/Retrieve key.

For T29G phones:

Icons	Description	Icons	Description
	Park successfully/Idle state.		Park failed.
	Ringing state.		Retrieve parked call.

## Parking a Call using a Park Key

You can set a line key as a Park key, and specify an extension or a shared parking lot you want to park a call to for this key. By using the Park key you can park a call quickly.

### Before You Begin

Check with your system administrator if the FAC or Transfer mode is set on your phone, and if **Account ID** it is necessary for this key.

### Procedure

1. Navigate to **Menu > Features > Dsskey**.
2. Select the desired line key.
3. Select **Key Event** from the **Type** field.
4. Select **Call Park** from **Key Type** field.
5. (Optional.) Select the desired line from the **Account ID** field.
6. Do one of the following:
  - (Optional.) Enter the string that will appear on the phone screen in the **Label** field.  
Enter the park extension number or the shared parking lot you want to park the call to in the **Value** field.
  - On the T29G phones, highlight the **Label** or **Value** field. Press **Directory (Dir)** and select a desired contact from the Directory list.
7. Select **Save**.

### Tip

By default, you can long press the desired line key to set it.

During a call, you can press the Call Park key, and the call is parked to the desired extension or the shared parking lot directly.

## Retrieving a Parked Call using a Retrieve Key

You can set a line key as a Retrieve key, and specify a parked extension or retrieve lot you want to retrieve a parked call from for this key. By using the Retrieve key you can retrieve a parked call quickly.

### Before You Begin

Check with your system administrator if the FAC or Transfer mode is set on your phone, and if **Account ID** is necessary for this key.

### Procedure

1. Navigate to **Menu > Features > Dsskey**.
2. Select the desired line key.
3. Select **Retrieve Park** from the **Type** field.
4. (Optional.) Select the desired line from the **Account ID** field.
5. Do one of the following:
  - (Optional.) Enter the string that will appear on the phone screen in the **Label** field.  
Enter the parked extension or the retrieve lot in the **Value** field.
  - On the T29G phones, highlight the **Label** or **Value** field. Press **Directory (Dir)** and select a desired contact from the Directory list.
6. Select **Save**.

#### Tip

By default, you can long press the desired line key to set it.

When there is a call parked on the extension or the shared parking lot, you can press the Retrieve key on the idle screen, and the call is retrieved from the parked extension or shared parking lot directly.

## Busy Lamp Field (BLF)

You can monitor a specific remote line using a BLF key for status changes on the phone. It is not available on the T19 (P) E2 phones.

### Topics

[State Indicator of Remote Line by BLF Key](#)

[Audio Alert for BLF Pickup](#)

[Visual Alert for BLF Pickup](#)

[Setting a BLF Key](#)

[Parking or Retrieving a Call by BLF Key](#)







[Picking up a Remote Call by BLF Key](#)

[Transferring a Call by BLF Key](#)

## State Indicator of Remote Line by BLF Key

You can get the monitored line's status by viewing the LED and icon indicator of the BLF key.

The state indicator of the BLF key varies by phone models.

LED Status	Icons	Description
	T29G	
Solid green		The monitored line is idle.
Fast-flashing red		The monitored line is ringing.
		The monitored line is dialing.
Solid red		The monitored line is busy or in a call.
Slowly-flashing red		The monitored line places a call on hold.
		A call is parked to the monitored line.
Off		The monitored line fails to register or does not exist.

## Audio Alert for BLF Pickup

The Audio Alert for BLF Pickup feature allows your phone to play a tone when the specified monitored line receives an incoming call.

### Topic

[Setting an Alert Tone for Monitored Lines](#)

## Setting an Alert Tone for Monitored Lines

You can set the alert ring type for the monitored lines to make it easier to recognize.

### Before You Begin

Check with your system administrator to find out if the Audio Alert for BLF Pickup feature is available.

### Procedure

1. Navigate to **Menu > Settings > Basic Settings > Sound > BLF Ring Type**.  
On the T29G phones, navigate to **Menu > Basic > Sound > BLF Ring Type**.
2. Select the desired ring tone.
3. Select **Save**.

## Visual Alert for BLF Pickup

Your system administrator can configure your phone to display the call information when the specified monitored line receives an incoming call.

You can select to pick up the call to the monitored line, place a call to the monitored line, place a new call or go back to the idle screen.



### Note

If you press **Cancel** to go back to the idle screen, you can long press the BLF key to enter the Calls for Pickup screen again.

## Setting a BLF Key

You can set a BLF key to monitor a specific line for status changes on the phone.

### Procedure

1. Navigate to **Menu > Features > Dsskey**.
2. Select the desired line key.
3. Select **BLF** from the **Type** field.
4. Select the desired line from the **Account ID** field.

5. Do one of the following:
  - (Optional.) Enter the string that will appear on the phone screen in the **Label** field.  
Enter the phone number or the extension you want to monitor in the **Value** field.
  - On the T29G phones, highlight the **Label** or **Value** field. Press **Directory (Dir)** and select a desired contact from the Directory list.
6. (Optional.) Enter the directed call pickup code in the **Extension** field.
7. Select **Save**.

#### Tip

By default, you can long press the desired line key to set it.

#### Note

During a call, you can press the BLF key to select a transfer mode. Check with your system administrator to find out if this feature is available on the phone.

## Picking up a Remote Call by BLF Key

When the monitored users are not at their desks and someone rings their lines, you can pick up the desired call simply by pressing the flashing BLF key.

If your system administrator set the directed call pickup code in advance, you can use the BLF key to pick up the call directly. If not or if you want to set a pickup code for a specific BLF line, you can set a pickup code for BLF key manually.

### Before You Begin

You have edited the BLF key's **Extension** field with the directed call pickup code from your system administrator.

### Procedure

1. When the monitored line receives an incoming call, you can do one of the following:
  - Press the BLF key to pick up the call for the monitored line directly.
  - Long press the BLF key.

*The **Pick Up**, **Send**, **New Call** and **Cancel** appear on the screen.*

Select **Pick Up** to pick up the call.

If there are multiple incoming calls on the monitored line, select the desired call to pick up.

### Related Topic

[Setting a BLF Key](#)

## Transferring a Call by BLF Key

When there is already an active call on the IP phones, you can transfer the active call to the monitored line by pressing the BLF key.

The phone transfers the active call differently depending on the Transfer Mode via Dsskey feature configured by your system administrator.

### Topics

[Performing a Blind Transfer](#)

[Performing a Semi-attended/Attended Transfer](#)

## Performing a Blind Transfer

During a call, you can transfer the call to the monitored contact in a blind-transfer way.

### Before You Begin

Check with your system administrator if the Transfer Mode via Dsskey is set to **Blind Transfer**.

### Procedure

1. During a call, press the BLF key of the monitored line which you want to transfer this call to.

## Performing a Semi-attended/Attended Transfer

During a call, you can transfer the call to the monitored contact in the semi-attended/attended-transfer way.

### Before You Begin

Check with your system administrator if the Transfer Mode via Dsskey is set to **Attended Transfer**.

### Procedure

1. During a call, press the BLF key of the monitored line which you want to transfer this call to.  
*The phone will dial out the number of the monitored line.*
2. Press the BLF key of the monitored line again or **Transfer (Trans)** to complete the transfer when the monitored user receives ringback or after the monitored user answers the call.

## Parking or Retrieving a Call by BLF Key

You can use the BLF key to park a call or retrieve a parked call directly.

### Note

Check with your system administrator to find out if it is available on your phone.

### Topics

[Parking a Call to a Monitored Line](#)

[Retrieving a Parked Call](#)

## Parking a Call to a Monitored Line

During the call, you can use the BLF key to park the current call to a monitored line directly.

### Before You Begin

Your system administrator has set call park feature in the FAC mode in advance.

### Procedure

1. During a call, select **Park** (You may need to select the **More** (  ) soft key to see the **Park** soft key).
2. Press the desired BLF key to park the call to the monitored line.

## Retrieving a Parked Call

You can use the BLF key to retrieve a call that is parked to the monitored line.

### Before You Begin

Your system administrator has set call park feature in the FAC mode.

### Procedure

1. Select **Retrieve** on the dialing screen.
2. Press the desired BLF key to retrieve a call that is parked to the monitored line.

## BLF List

BLF List feature enables you to monitor a list of users defined by your system administrator, and the respective key LEDs or icons will either flash or glow depending on the status of monitored lines.

It is not available on the T19(P) E2 phones. Check with your system administrator to find out if this feature is available on your phone.

### Topics

[State Indicator of Remote Line by BLF List Key](#)

[Audio Alert for BLF Pickup](#)

[Visual Alert for BLF Pickup](#)

[Ring Type for BLF Parked Call Monitor](#)

[Visual Alert for BLF Parked Call Monitor](#)

[Picking up a Remote Call by BLF List Key](#)

[Transferring a Call by BLF List Key](#)

[Parking a Call by a BLF List Key](#)

[Retrieving a Call by a BLF List Key](#)







[Barging in an Active Call by BLF List Key](#)

[Retrieving a Call Parked to the Monitored Line](#)

## State Indicator of Remote Line by BLF List Key

You can get the monitored line's status by viewing the LED and icon indicator of the BLF List key.

The state indicator of the BLF list key varies by phone models.

LED Status	Icons	Description
	T29G	
Solid green		The monitored line is idle.
Fast-flashing red		The monitored line is ringing.
		The monitored line is dialing.
Solid red		The monitored line is busy or in a call.
Slowly-flashing red		The monitored line places a call on hold.
		A call is parked to the monitored line.
Off		The monitored line fails to register or does not exist.

## Audio Alert for BLF Pickup

The Audio Alert for BLF Pickup feature allows your phone to play a tone when the specified monitored line receives an incoming call.

### Topic

[Setting an Alert Tone for Monitored Lines](#)



## Setting an Alert Tone for Monitored Lines

You can set the alert ring type for the monitored lines to make it easier to recognize.

### Before You Begin

Check with your system administrator to find out if the Audio Alert for BLF Pickup feature is available.

### Procedure

1. Navigate to **Menu > Settings > Basic Settings > Sound > BLF Ring Type**.  
On the T29G phones, navigate to **Menu > Basic > Sound > BLF Ring Type**.
2. Select the desired ring tone.
3. Select **Save**.

## Visual Alert for BLF Pickup

Your system administrator can configure your phone to display the call information when the specified monitored line receives an incoming call.

You can select to pick up the call to the monitored line, place a call to the monitored line, place a new call or go back to the idle screen.



### Note

If you press **Cancel** to go back to the idle screen, you can long press the BLF List key to enter the Calls for Pickup screen again.

## Ring Type for BLF Parked Call Monitor

The Audio Alert for BLF Parked Call Monitor feature allows your phone to play a tone when a call is parked against the monitored user's phone number.

### Topic

[Setting an Alert Tone for the BLF Parked Call Monitor](#)

## Setting an Alert Tone for the BLF Parked Call Monitor

You can set the alert ring type when there is a call parked to the monitored lines.

### Before You Begin

Check with your system administrator to find out if the Audio Alert for BLF Parked Call Monitor feature is available.

### Procedure

1. Navigate to **Menu > Settings > Basic Settings > Sound > Ring Type for BLF Parked Call Monitor**.  
On the T29G phones, navigate to **Menu > Basic > Sound > Ring Type for BLF Parked Call Monitor**.

2. Select the desired ring tone.
3. Select **Save**.

## Visual Alert for BLF Parked Call Monitor

Your system administrator can configure your phone to display the call information when the specified monitored line receives an incoming call.

You can select to retrieve the call parked to the monitored line, place a call to the monitored line, place a new call or go back to the idle screen.



## Picking up a Remote Call by BLF List Key

When the monitor user is not at his/her desk and someone rings his/her line, you can pick up the call simply by pressing the flashing BLF List key. You can also check the caller ID first, and then pick up the incoming call.

### Before You Begin

Check with your system administrator to find out if this feature is available on your phone.

### Procedure

1. Do one of the following:
  - Press the BLF List key to pick up the call for the monitored line directly.
  - Long press the BLF List key.

*The **Pick Up**, **Send**, **New Call** and **Cancel** appear on the screen.*

Select **Pick Up** to pick up the call.

If there are multiple incoming calls on the monitored line, select the desired call to pick up.

## Transferring a Call by BLF List Key

When there is already an active call on the IP phones, you can transfer the active call to the monitored user by pressing the BLF List key.

The phone transfers (Blind Transfer or Attended Transfer) the active call differently depending on the Transfer Mode via Dsskey feature configured by your system administrator.

### Note

During a call, you can press the BLF List key to select a transfer mode. Check with your system administrator to find out if this feature is available on the phone.

### Topics

[Performing a Blind Transfer](#)

[Performing a Semi-attended/Attended Transfer](#)

## Performing a Blind Transfer

During a call, you can use the BLF List key to perform a blind transfer to the monitored line.

### Before You Begin

Check with your system administrator to make sure that the Transfer Mode via Dsskey is set to **Blind Transfer**.

### Procedure

1. During a call, press the BLF List key of the monitored line which you want to transfer this call to.

## Performing a Semi-attended/Attended Transfer

During a call, you can use the BLF List key to perform a semi-attended/attended transfer to the monitored line.

### Before You Begin

Check with your system administrator if the Transfer Mode via Dsskey is set to **Attended Transfer**.

### Procedure

1. During a call, press the BLF List key of the monitored line which you want to transfer this call to.  
*The phone will dial out the number of the monitored line.*
2. Press the BLF List key of the monitored user again or **Transfer (Trans)** to complete the transfer when the monitored user receives ringback or after the monitored user answers the call.

## Parking a Call by a BLF List Key

You can use the BLF List key to park a call to the monitored user who is idle.

### Before You Begin

Check with your system administrator to find out if this feature is available on your phone.

### Procedure

1. During a call, press the desired BLF List key.

## Retrieving a Call by a BLF List Key

You can use the BLF List key to retrieve a call which is parked to the monitored line.

### Before You Begin

Check with your system administrator to find out if this feature is available on your phone.

### Procedure

1. Do one of the following:
  - Press the desired **BLF List** key to retrieve a call that is parked to the monitored line.
  - Long press the BLF List key.  
*The **Retrieve**, **Send**, **New Call** and **Cancel** appear on the screen.*  
Select **Retrieve** to retrieve the call.

## Barging in an Active Call by BLF List Key

You can use the BLF List key to barge in a conversation and set up a conference call.

### Before You Begin

Check with your system administrator to find out if this feature is available on your phone.

#### Procedure

1. Do one of the following:

- Press the BLF List key.
- Long press the BLF List key.

*The **Barge In**, **Send**, **New Call** and **Cancel** appear on the screen.*

Select **Barge In**.

*The phone dials out the barge-in code followed by the monitored line, and then you can join the call. Each of the three parties can hear the other two parties.*

## Retrieving a Call Parked to the Monitored Line

When a call is parked to the monitored line, you can retrieve the parked call on the phone.

#### Before You Begin

Check with your system administrator to find out if Visual Alert for BLF Parked Call Monitor is enabled on your phone.

#### Procedure

1. Select **Retrieve**.

## Shared Line

Yealink phone supports using Shared Call Appearance (SCA) or Bridged Line Appearance (BLA) to share a line. So that this line can be registered on more than one phone at the same time.

Your system administrator can set your phone to use the shared line.

#### Topics

[State Indicator of Shared Line](#)

[Placing Calls on a Shared Line](#)

[Answering Calls on a Shared Line](#)

[Placing a Call on Public Hold](#)

[Placing a Call on Private Hold](#)

[Retrieving a Held Call on a Shared Line](#)



[Barging in an Active Call on a Shared Line](#)









[Pulling a Shared Call on a Shared Line](#)

## State Indicator of Shared Line

You can get the shared line's status by viewing the LED and icon indicator of the shared line key.

The following table shows all kinds of LED and icon indicator associated with the shared line and the corresponding descriptions:

Line Key LED except for T19(P) E2	Icons	Description
	T29G	
Off		The shared line is idle.
Solid green		The shared line is seized.

Line Key LED except for T19(P) E2	Icons	Description
	T29G	
Fast-flashing green		The shared line receives an incoming call.
Solid green		The shared line is dialing.
Solid green		The shared line is busy or is in a call.
Slowly-flashing green (local phone) Slowly-flashing red (other phones)		The call on the shared line is placed on public hold.
Slowly-flashing green (local phone) Solid red (other phones)	 (Local SCA Phone)  (Other Phone)	The call on the shared line is placed on private hold.
Solid green		The call on the shared line is barged in by the other shared line user.
Slowly-flashing green		In a multi-party call, place the call on hold locally.

## Placing Calls on a Shared Line

You can place one or multiple calls on a shared line.

The phone places a call on the first shared line key automatically. You can select the desired shared line key first and place a call using this key. Line key is not available on the T19(P) E2 phone.

### Related Topic

[Placing Calls](#)

## Answering Calls on a Shared Line

You can answer one or more calls on the shared line.

When an incoming call arrives on the shared line, all the registered phones will ring simultaneously, and the call can be answered on any one of the phones. Incoming calls will be distributed evenly among the available shared line keys. Line key is not available on the T19(P) E2 phone.

### Note

If the number of incoming calls is greater than the configured line keys, the line keys will be used by sequence circulation. Contact your system administrator for more information.

### Related Topic

[Answering Calls](#)

## Placing a Call on Public Hold

You can place a call on public hold that any shared line phone can retrieve the held call.

### Procedure

1. During a call, press the HOLD key or **Hold**.

*The call is held on your phone, and all of the phones registered with a shared line show the call is in a held state on the shared line key.*

## Placing a Call on Private Hold

In SCA scenario, you can place a call on private hold that only you can retrieve the held call.

The **PriHold** soft key can be preset by your system administrator, you can also set a line key as the private hold key manually if the **PriHold** soft key is not available on your phone. You need to configure a private hold key before you place the call on private hold. Private Hold key is not available on the T19(P) E2 phone.

### Procedure

1. Navigate to **Menu > Features > Dsskey**.
2. Select the desired line key.
3. Select **Key Event** from the **Type** field.
4. Select **Private Hold** from the **Key Type** field.
5. (Optional.) Enter the string that will display on the phone screen in the **Label** field.
6. Select **Save**.

### Tip

By default, you can long press the desired line key to set it.

During an SCA call, press **PriHold** or Private Hold key on the phone (You may need to press the **More** (  ) soft key to see the **PriHold** soft key). Then the call is held on your phone, and the other phones registered with a shared line show the call is in the busy state on the shared line key. Other users on the shared line cannot resume your held call.

## Retrieving a Held Call on a Shared Line

If you place a call on hold on a shared line, you can resume this call at any time. When the shared line key shows a call that is in a held state, you can resume the held call remotely from other user's phone.

It is not available on the T19(P) E2 phone.

### Before You Begin

There is at least one call placed on public hold on the shared line.

### Procedure

1. Do one of the following:
  - Press the line key.
  - In SCA scenario, long press the shared line key.
 

*The **Cancel**, **Call Pull (CallPull)**, **New Call (NewCall)** and **Retrieve** appear on the screen.*

 Select **Retrieve** to retrieve the call.

## Barging in an Active Call on a Shared Line

In SCA scenario, you can barge into an active call on the shared line. After you barge into a call, the call turns into a three-party conference.

### Note

Only one user can barge into an active call on the shared line at a time.

It is not available on the T19(P) E2 phones.

**Before You Begin**

There is at least one active call on the shared line.

**Procedure**

1. Long press the desired line key, and then select an active call.

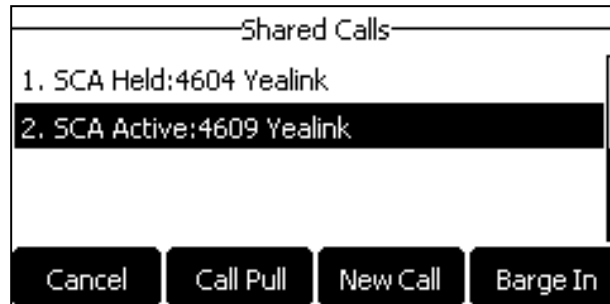

*The **Cancel**, **Call Pull (CallPull)**, **New Call (NewCall)** and **Barge In (BargeIn)** appear on the phone screen.*

2. Select **Barge In (BargeIn)** to interrupt the active call.

**Pulling a Shared Call on a Shared Line**

In SCA scenario, both you and other users can pull an existing call from another shared phone that is an active or hold state.

It is not available on the T19(P) E2 phone. Check with your system administrator to find out if this feature is available for your phone.

**Before You Begin**

There is an active or held call on the shared line.

**Procedure**

1. Long press the line key, and then select a call.



2. Select **Call Pull (CallPull)** to pull the call.

**Intercom**

Intercom is a useful feature in an office environment to quickly connect with the operator or the secretary.

Intercom enables you to place an intercom call that is answered automatically on the contact's phone as long as the contact is not in an active call.

**Note**

Intercom is not available on all servers. Contact your system administrator for more information.

**Topics**

[State Indicator of the Intercom key](#)

[Placing an Intercom Call](#)





[Picking up an Incoming Call of the Target Extension](#)

[Answering an Intercom Call](#)

## State Indicator of the Intercom key

On T29G phones, you can get the intercom status by viewing the icon indicator of the Intercom key.

For T29G phones:

Icons	Description	Icons	Description
	Target extension is available.		Target extension is ringing.
 Callout	Target extension is dialing.	 Talking	Target extension is busy or is in a call.
	Target extension fails to register.		

## Placing an Intercom Call

You can place an intercom call to quickly relay a message to a contact.

The target phone plays a warning tone and automatically answers the call in speakerphone (hands-free) mode by default. When the target phone has an active call, the intercom call is answered automatically after the active call ends.

You can also press the BLF/BLF List key to initiate an outgoing intercom call to the monitored user. Check with your system administrator to find out if it is available on your phone.

**Before You Begin**

If you are using the T19(P) E2 phones, check with your system administrator if the Intercom key has set for your phone.

**Procedure**

1. Navigate to **Menu > Features > Dsskey**.
2. Select the desired line key.
3. Select **Intercom** from the **Type** field.
4. Select the desired line from the **Account ID** field.
5. Do one of the following:
  - (Optional.) Enter the string that will appear on the phone screen in the **Label** field.  
Enter the target extension number in the **Value** field.
  - On the T29G phones, highlight the **Label** or **Value** field. Press **Directory (Dir)** and select a desired contact from the Directory list.
6. Select **Save**.
7. Press the Intercom key to place an intercom call.

**Tip**

By default, you can long press the desired line key to set it.



## Related Topic

[Setting a BLF Key](#)

## Picking up an Incoming Call of the Target Extension

You can pick up the target extension's incoming call by pressing the Intercom key.

Before picking up an incoming call, make sure that the directed call pickup code has been configured either for an Intercom key or for Call Pickup feature in advance.

Check with your system administrator to find out if this feature is available on your phone.

### Note

If the directed call pickup code is not set, the phone will place a call to the target extension instead of picking up an incoming call of the target extension when you press the Intercom key.

### Before You Begin

Get the directed call pickup code from your system administrator.

### Procedure

1. Long press the Intercom key.
2. Enter the directed call pickup code in the **Extension** field.
3. Select **Save**.

When the target extension receives an incoming call, the Intercom key LED of the target extension will flash green. The Intercom key LED is not available on T19(P) E2. Press the Intercom key to pick up the incoming call directly.

## Answering an Intercom Call

By default, when there is an incoming intercom call, the phone plays a warning tone and automatically answer the incoming call.

During the intercom call, you can switch among the Speakerphone (hands-free), Handset and headset modes. If your phone is set to answer intercom calls with your microphone muted, you need to press the Mute key to unmute your microphone before responding to the call.

You can configure the following behaviors when receiving an intercom call.

### Intercom Allow

Intercom Allow feature allows the phone to automatically answer an incoming intercom call. If you disable this feature, the phone will handle an incoming intercom call like a normal incoming call.

### Note

Your system administrator can set a period of delay time before the phone automatically answers intercom calls.

### Intercom Mute

Intercom Mute feature allows the phone to mute the microphone when incoming intercom calls are answered automatically.

### Intercom Tone

Intercom Tone feature allows the phone to play a warning tone before answering an intercom call automatically.

### Intercom Barge

Intercom Barge allows the phone to automatically answer an incoming intercom call while an active call is in progress. The active call will be placed on hold. If you disable this feature, the phone will handle an incoming intercom call like a normal incoming call while there is already an active call on the phone.

#### Note

To enable the phone to receive a new incoming call when it already has an active call, make sure that the call waiting feature is enabled on the phone in advance.

#### Procedure

1. Navigate to **Menu > Features > Intercom**.
2. Make the desired changes.
3. Select **Save**.

#### Related Topics

[Switching Among the Handset, Speakerphone and Headset Modes](#)

[Muting/Unmuting Audio](#)

[Answering a Call When in a Call](#)

## Short Message Service (SMS)

Text messages can be stored in your phone's Inbox, Sentbox, Outbox or Draftbox, and each box stores up to 100 text messages.

If there are more than 100 text messages in any one of the boxes, the phone will directly delete the oldest text message in the box.

#### Note

SMS is not available on all servers. Contact your system administrator for more information.

#### Topics

[Reading a Text Message](#)

[Sending a Text Message](#)

[Replying to a Text Message](#)

[Deleting a Text Message](#)

## Reading a Text Message

You can read your text messages on the phone, to obtain text information sent by a contact.

#### Procedure

1. Navigate to **Menu > Message > Text Message > Inbox**.
2. Highlight the desired message and select **View**.

#### Tip

If the phone prompts you there is a new text message, you can select the **View** soft key to read the new messages directly. But your system administrator can disable the prompt box for the new message(s).

## Sending a Text Message

The phones can send text messages.

#### Procedure

1. Navigate to **Menu > Message > Text Message > New Message**.
2. Compose the new text message.
3. Select **Send**.
4. Select the desired account from the **From** field.
5. Do one of the following:
  - Enter the number you want to send the message to in the **To** field.
  - On the T29G phones, highlight the **Label** or **Value** field. Press **Directory (Dir)** and select a desired contact from the Directory list.
6. Send the message.

## Replying to a Text Message

You can reply to a message after reading a text message.

### Procedure

1. Navigate to **Menu > Message > Text Message > Inbox**.
2. Highlight the desired message and select **Reply**.
3. Compose the new text message.
4. Select **Send**.

## Deleting a Text Message

You can delete messages from your phone after reading.

### Procedure

1. Navigate to **Menu > Message > Text Message > Inbox (Sentbox, Outbox or Draftbox)**.
2. Highlight the desired message.
3. Select **Option > Delete**.  
*The phone prompts you whether to delete the message.*
4. Select **OK**.

You can also delete all text messages by selecting the **Delete All**.

## Voice Mail

Voice Mail feature allows you to leave voice mails for someone or listen to your voice mail messages on your IP phones.

This feature is set up on the server-side and not all servers support this feature.

### Topics

[Setting the Voice Mail Code](#)

[Leaving Voice Mails](#)

[Listening to Voice Mails](#)

## Setting the Voice Mail Code

If you want to connect your phone to the message center, you need to set the voice mail code on your phone.

### Before You Begin

Get the voice mail code from your system administrator.

### Procedure

1. Navigate to **Menu > Message > Voice Mail > Set Voice Mail Code**.

You can also press the MESSAGE key when the voice mail code is not configured.

2. Enter the voice mail code (for example, \*4) in the desired account field.
3. Select **Save**.

## Leaving Voice Mails

You can leave a voice mail to someone who is busy or inconvenient to answer the call.

### Procedure

1. Follow the voice prompts to leave a voice mail.
2. Hang up to complete the voice mail.

## Listening to Voice Mails

You can listen to your voice mails on the phone, to obtain voice information sent by a contact.

### Before You Begin

You need to set the voice mail code in advance.

### Procedure

1. Navigate to **Menu > Message > Voice Mail > View Voice Mail**.

*The phone screen displays the amount of new and old voice mails.*

2. Highlight an account, and then select **Connect**.
3. Follow the voice prompt to listen to your voice mails.

### Tip

When the phone prompts that the phone receives a new voice mail, you can press the MESSAGE key or **Connect** soft key to dial out the voice mail access code directly.

### Related Topic

[Setting the Voice Mail Code](#)

## Using the Hot Desking

You can use hot desking to log out from the current account and then log in to a new account. So many users can share one phone resource at different times.

### Note

Hot desking is not available on all servers. Contact your system administrator for more information.

### Before You Begin

Your system administrator has set a Hot Desking key for you to use this feature. Get the login account information from your system administrator.

### Procedure

1. Press the Hot Desking key when the phone is idle.

*The phone prompts you whether to clear the account configuration.*

**2. Select **OK**.**

*Registration configurations of all accounts on the phone will be cleared immediately.*

*The login wizard will be displayed.*

**3. Enter the login information.****4. Select **Save**.**

## Automatic Call Distribution (ACD)

ACD is often used in offices for customer service, such as call center.

The ACD system handles large volumes of incoming calls from callers who have no need to talk to a specific person but who require assistance from any of multiple persons at the earliest opportunity. ACD on all IP phones allows the ACD system to distribute large volumes of incoming calls to the registered ACD users.

ACD is not available by default. Check with your system administrator to find out if this feature is available on your phone.

### Topics

[State Indicator of ACD User](#)









[Logging into the ACD System](#)

[Changing the ACD Status](#)

## State Indicator of ACD User

You can get the ACD user's status by viewing the line key LED and icon indicator of the ACD key.

The state indicator of the ACD key varies by phone models.

Line key LED Status	Icons		Description
	T27G/T23G/T23P/T21(P) E2	T29G	
Off			Log out
Solid green			Available/Log in
Solid red			Wrap up
Fast-flashing green	 ×		Unavailable

## Logging into the ACD System

After logging into your ACD account, you are ready to receive calls from the ACD system.

### Before You Begin

Your system administrator has set an ACD key for you to log into the ACD system. Get your ACD account information from your system administrator.

### Procedure

1. Press the ACD key when the phone is idle.
2. Enter your ACD account information.
3. Select **Login**.

## Changing the ACD Status

You can press the ACD key to change your current ACD user status.

**Procedure**

1. Press **Available (Avail)/Unavailable (Unavail)**.

*ACD user status synchronizes on both the phone and ACD system.*

2. To log out of the ACD system, select **Logout**.

---

# Directory

The phone provides several types of phone directories, which can be customized by your system administrator.

## Topics

[Local Directory](#)  
[Favorites](#)  
[Blacklist](#)  
[Mobile Contacts](#)  
[Google Contacts](#)  
[Remote Phone Book](#)

## Local Directory

You can store up to 1000 contacts and 48 groups in your local directory, you can search, add, edit and delete a contact.

### Note

You can back up the Local Directory to the provisioning server. For more information, contact your system administrator.

## Topics

[Managing the Local Directory Groups](#)  
[Managing the Local Directory Contacts](#)  
[Moving a Local Directory Contact to Blacklist](#)  
[Searching for Contacts](#)

## Managing the Local Directory Groups

You can manage the Local Directory groups when the phone is idle.

## Topics

[Adding Contact Groups](#)  
[Editing Contact Groups](#)  
[Deleting Contact Groups](#)

## Adding Contact Groups

To organize your contacts and make them easier to find, you can add additional groups in the Local Directory.

### Procedure

1. Select **Directory (Dir)** or navigate to **Menu > Directory > Local Directory**.
2. Select **Add Group (AddGr)**.
3. Enter the desired group name.
4. Select **Add** or **Save**.

## Editing Contact Groups

You can change or add the group's information.

### Procedure

1. Select **Directory (Dir)** or navigate to **Menu > Directory > Local Directory**.
2. Highlight the desired group.

3. Select **Option** > **Detail**.
4. Edit the group information.
5. Select **Save**.

## Deleting Contact Groups

When you delete a contact group, the contacts in the group will not be deleted. You can view the contacts in **All Contacts** list.

### Procedure

1. Select **Directory (Dir)** or navigate to **Menu > Directory > Local Directory**.
2. Highlight the desired group.
3. Select **Option** > **Delete**.

*The phone prompts you whether to delete the group.*

4. Select **OK**.

## Managing the Local Directory Contacts

You can manage the Local Directory contacts when the phone is idle.

### Topics

[Adding Contacts](#)

[Viewing Contacts](#)

[Editing Contacts](#)

[Deleting a Contact](#)

[Deleting All Contacts](#)

## Adding Contacts

When you add a contact to your Local Directory, you can choose how much information you want to enter for your contact. You are required to enter a contact name at least for each new contact.

### Procedure

1. Select **Directory (Dir)** or navigate to **Menu > Directory > Local Directory**.
2. Select the desired contact group or **All Contacts**.
3. Select **Add**.
4. Enter your contact's information.
5. Select the desired account from the **Account** field.
6. On the T29G phones, select the desired photo from the **Photo** field.
7. Select **Save** or **Add**.

## Viewing Contacts

You can view the local contacts from the Local Directory on your phone.

### Procedure

1. Select **Directory (Dir)** or navigate to **Menu > Directory > Local Directory**.
2. Select the desired contact group or **All Contacts**.

*The contact names are displayed in alphabetical order.*

## Editing Contacts

You can update your contacts' information.



### Procedure

1. Select **Directory (Dir)** or navigate to **Menu > Directory > Local Directory**.
2. Select the desired contact group or **All Contacts**.
3. Highlight the desired contact, and select **Option > Detail**.
4. Edit the contact information.
5. Select **Save**.

## Deleting a Contact

You can delete any contact from the Local Directory.

### Procedure

1. Select **Directory (Dir)** or navigate to **Menu > Directory > Local Directory**.
2. Select the desired contact group or **All Contacts**.
3. Highlight the desired contact, and select **Option > Delete**.  
*The phone prompts you whether to delete the contact.*
4. Select **OK**.

#### Note

If the contact added to the Favorites directory is deleted in the Local Directory, it will be automatically deleted from the Favorites directory.

## Deleting All Contacts

You can delete all contacts from the Local Directory.

### Procedure

1. Select **Directory (Dir)** or navigate to **Menu > Directory > Local Directory**.
2. Select the desired contact group or **All Contacts**.
3. Select **Option > Delete All**.  
*The phone prompts you whether to delete all contacts.*
4. Select **OK**.

#### Note

If the contact added to the Favorites directory is deleted in the Local Directory, it will be automatically deleted from the Favorites directory.

## Moving a Local Directory Contact to Blacklist

You can move a contact in the Local Directory to blacklist. Incoming calls from this contact will be rejected automatically.

### Procedure

1. Select **Directory (Dir)** or navigate to **Menu > Directory > Local Directory**.
2. Select the desired contact group or **All Contacts**.
3. Highlight the desired contact, and select **Option > Add to Blacklist**.  
*The phone prompts you whether to move to the blacklist.*
4. Select **OK**.

## Searching for Contacts

In the Local Directory, you can enter search criteria to find your desired contact quickly.

### Procedure

1. Select **Directory (Dir)** or navigate to **Menu > Directory > Local Directory**.
2. Select **Search**.
3. Enter your search criteria in the search field.

## Favorites

Favorites are the contacts in your Local Directory that you call most often.

If your system administrator has enabled this feature for you, you can add contacts as favorites, view favorites on the idle screen, reorder favorites, and delete favorites.

### Topics

[Adding Favorites](#)

[Viewing Favorites](#)

[Reordering Favorites](#)

[Deleting Favorites](#)

## Adding Favorites

After adding a contact as a favorite, your phone will automatically assign a Speed Dial key for it. You can quickly dial a contact using the Speed Dial key on the idle screen.

On all IP phones except the black-and-white screen phones, a star is displayed in the Local Directory for a contact saved as the favorite.

### Topics

[Adding an Existing Contact to Your Favorites](#)

[Adding a New Contact to Your Favorites](#)

## Adding an Existing Contact to Your Favorites

You can add an existing contact as a favorite from the Local Directory.

### Procedure

1. Select **Directory (Dir)** or navigate to **Menu > Directory > Local Directory**.
2. Select the desired contact group or **All Contacts**.
3. Highlight the desired contact and select **Option**.
4. Select **Copy to Favorites**.

*The phone prompts you whether to automatically accept the next available index number or manually enter your own.*

5. Select **OK** to automatically accept an index number or select **Edit** to enter an index number (1-99999999).

## Adding a New Contact to Your Favorites

You can add a new contact as a favorite by designating an index number.

### Procedure

1. Select **Directory (Dir)** or navigate to **Menu > Directory > Local Directory**.
2. Select the desired contact group or **All Contacts**.
3. Select **Add**.
4. Enter the contact information.

5. Enter the desired index number (1-999999999) in the **Favorite Index** field.
6. Select **Save** or **Add**.

**Tip**

To quickly add a favorite, long press the desired line key to enter the Add Contact screen. Check with your system administrator to find out if this feature is available on your phone.

## Viewing Favorites

You can view a list of favorites in the Favorites directory.

**Procedure**

1. Navigate to **Menu > Directory > Favorites**.

## Reordering Favorites

You can reorder favorites to change the display order in the Favorite.

**Procedure**

1. Navigate to **Menu > Directory > Favorites**.
2. Highlight the desired contact, and select **Option > Detail**.
3. Enter a new index number in the **Favorites Index** field.
4. Select **Save**.

## Deleting Favorites

You can delete favorites to make room for new favorites.

**Procedure**

1. Navigate to **Menu > Directory > Favorites**.
2. Highlight the desired contact, and then select **Option > Detail**.
3. Delete the favorite index number in the **Favorites Index** field.
4. Select **Save**.

*The contact is removed from Favorites directory, while it still remains in your Local Directory.*

**Tip**

You can also delete a favorite by selecting **Option > Remove from Favorites**.

## Blacklist

Incoming calls from the Blacklist are rejected automatically. You can store up to 30 contacts in the blacklist to block unwanted callers.

**Topics**

[Adding a Blacklist Contact](#)

[Viewing Blacklist Contacts](#)

[Editing a Blacklist Contact](#)

[Deleting Blacklist Contacts](#)

[Moving a Blacklist Contact to the Local Directory](#)

## Adding a Blacklist Contact

You can add a blacklist contact on the phone to prevent someone from calling you.

### Procedure

1. Navigate to **Menu > Directory > Blacklist**.
2. Select **Add**.
3. Enter the blacklist contact's information.
4. Select **Save** or **Add**.

## Viewing Blacklist Contacts

You can view the blacklist contacts from the Blacklist on your phone.

### Procedure

1. Navigate to **Menu > Directory > Blacklist**.

## Editing a Blacklist Contact

You can update your blacklist contacts' information.

### Procedure

1. Navigate to **Menu > Directory > Blacklist**.
2. Highlight the desired blacklist contact, and select **Option > Detail**.
3. Edit the blacklist contact information.
4. Select **Save**.

## Deleting Blacklist Contacts

You can delete one or all blacklist contacts. If a contact is removed from the blacklist, you can answer the call from the contact normally.

### Topics

[Deleting a Blacklist Contact](#)

[Deleting All Blacklist Contacts](#)

## Deleting a Blacklist Contact

If you want to answer a call from a specific contact, you need to remove it from the Blacklist.

### Procedure

1. Navigate to **Menu > Directory > Blacklist**.
2. Select the desired blacklist contact.
3. Select **Option > Delete**.  
*The phone prompts you whether to delete the contact.*
4. Select **OK**.

## Deleting All Blacklist Contacts

You can delete all contacts from the Blacklist when you are ready to answer calls from them again.

### Procedure

1. Navigate to **Menu > Directory > Blacklist**.
2. Select **Option > Delete All**.  
*The phone prompts you whether to delete all contacts.*
3. Select **OK**.

## Moving a Blacklist Contact to the Local Directory

You can move a blacklist contact to a Local Directory. Incoming calls from this contact will not be rejected automatically.

### Procedure

1. Navigate to **Menu > Directory > Blacklist**.
2. Highlight the desired contact, and then select **Option**.
3. Select **Add to Contacts**.  
*The phone prompts you whether to move to contact.*
4. Select **OK**.

## Mobile Contacts

On the T29G/T27G phones, you can synchronize the contacts on your mobile phone to your IP phone. The mobile phone contacts will be imported to your IP phones and stored under Mobile Contacts directory.

You can save mobile contacts to the local directory, but you cannot save a local contact to Mobile Contacts directory.

### Note

If you disconnect the Bluetooth-enabled mobile phone from phone or disable the phone to synchronize phone contacts, the mobile contacts will not be displayed.

### Topics

[Saving a Mobile Contact to the Local Directory](#)

[Searching for Mobile Contacts](#)

[Updating the Mobile Contacts](#)

## Saving a Mobile Contact to the Local Directory

You can save any mobile contact to the Local Directory, to conveniently call this contact after disconnecting the mobile phone from the phone.

### Before You Begin

Make sure your Bluetooth-enabled mobile phone has been paired with your IP phones, and mobile contact sync feature is enabled.

### Procedure

1. Navigate to **Menu > Directory > Mobile Contacts**.
2. Highlight the desired contact, and select **Option > Add to Contacts**.
3. Edit the contact information.
4. Select **Save**.

### Related Topics

[Pairing and Connecting the Bluetooth-enabled Mobile Phone](#)

[Syncing the Mobile Contacts to the Phone](#)

## Searching for Mobile Contacts

In Mobile Contacts, you can enter search criteria to find your desired mobile contact quickly.

### Before You Begin

Make sure your Bluetooth-enabled mobile phone has been paired with and connected to your IP phones, and mobile contact sync feature is enabled.

### Procedure

1. Navigate to **Menu > Directory > Mobile Contacts**.
2. Select **Search**.
3. Enter your search criteria.

*The contacts whose name or phone number matches the search string will be displayed in the result list.*

### Related Topics

[Pairing and Connecting the Bluetooth-enabled Mobile Phone](#)  
[Syncing the Mobile Contacts to the Phone](#)

## Updating the Mobile Contacts

You can update the Mobile Contact to synchronize the contacts you add, edit, and delete on the mobile phone to your phone.

### Before You Begin

Make sure your Bluetooth-enabled mobile phone has been paired with and connected to your phones, and mobile contact sync feature is enabled.

### Procedure

1. Navigate to **Menu > Directory > Mobile Contacts**.
2. Select **Option > Update**.

*The phone prompts "Updating, please wait..."*

### Note

If you disconnect the mobile phone from the phone when the phone is updating the Mobile Contacts, the phone screen will prompt "Fail to download mobile contacts!", and the mobile contacts disappear from the phone directory list.

### Related Topics

[Pairing and Connecting the Bluetooth-enabled Mobile Phone](#)  
[Syncing the Mobile Contacts to the Phone](#)

## Google Contacts

If the Google Contacts feature has been enabled by your system administrator, you can access the Google Contacts, which lists contacts and groups within your Google account.

### Topics

[Viewing Google Contacts](#)  
[Updating Google Contacts](#)  
[Searching for Google Contacts](#)

## Viewing Google Contacts

You can view Google contacts on your phone.

### Procedure

1. Navigate to **Menu > Directory > Google Contact**.

## Updating Google Contacts

The Google contacts may be updated on the Google Contact Server, you can update Google contacts on your phone to get the newest Google contacts.

### Procedure

1. Navigate to **Menu > Directory > Google Contact**.
2. Select **Update**.

## Searching for Google Contacts

You can enter search criteria to find your desired Google contacts quickly.

### Procedure

1. Navigate to **Menu > Directory > Google Contact**.
2. Enter the search criteria.

*The contacts whose name or phone number matches the search criteria will be displayed in the result list.*

## Remote Phone Book

If the Remote Phone Book feature has been enabled by your system administrator, you can access your corporate directory directly from your phone.

### Topics

[Searching for Remote Phone Book Contacts](#)

[Viewing Remote Phone Book Contacts](#)

[Saving a Remote Phone Book Contact to the Local Directory](#)

[Saving a Remote Phone Book Contact to the Blacklist](#)

## Searching for Remote Phone Book Contacts

In the Remote Phone Book, you can enter search criteria to find your desired contact quickly.

### Note

You can only search the contact name or contact numbers, search criteria do not include extra information on the contact.

### Procedure

1. Navigate to **Menu > Directory > Remote Phone Book**.
2. Select the desired remote phone book.
3. Select **Search**.
4. Enter your search criteria in the search field.

## Viewing Remote Phone Book Contacts

You can view the contact list of the remote phone book on your phone.

### Procedure

1. Navigate to **Menu > Directory > Remote Phone Book**.

## Saving a Remote Phone Book Contact to the Local Directory

You can save any remote phone book contact to the Local Directory, to conveniently call this contact when you cannot access the remote phone book.

### Procedure

1. Navigate to **Menu > Directory > Remote Phone Book**.
2. Select the desired remote phone book.
3. Highlight the desired contact, and then press **Option > Add to Contacts**.
4. Edit the corresponding fields.
5. Select **Save**.

## Saving a Remote Phone Book Contact to the Blacklist

You can save any remote phone book contact to the Blacklist on the phone, to prevent this contact from calling you.

### Procedure

1. Navigate to **Menu > Directory > Remote Phone Book**.
2. Select the desired remote phone book.
3. Highlight the desired contact, and select **Option > Add to Blacklist**.
4. Edit the contact information.
5. Select **Save**.



## Call History

The call history list includes Missed Calls, Placed Calls, Received Calls and Forwarded Calls, and each list holds 100 entries.

### Topics

[Call History Icons](#)

[Viewing History Records](#)

[Saving a History Record to Local Directory](#)

[Saving a History Record to Blacklist](#)



[Deleting History Records](#)

[Disabling History Record](#)





## Call History Icons

Each icon in the Call History indicates the corresponding call history status.

For T29G phones:

Icons	Description	Icons	Description
	Received Call		Missed Call
	Placed Call		Forwarded Call

For T27G/T23G/T23P/T21(P) E2/T19(P) E2 phones:

Icons	Description	Icons	Description
	Received Call		Missed Call
	Placed Call		Forwarded Call

## Viewing History Records

The history record saves the call information such as the caller's name and number, local line and call duration.

### Procedure

1. Press **History** or navigate to **Menu > History**.
2. Select the desired list.
3. Select the desired entry.
4. Select **Option > Detail**.

## Saving a History Record to Local Directory

To identify someone's call the next time, you can save a history record to the Local Directory.

### Procedure

1. Select **History** or navigate to **Menu > History**.
2. Select the desired list.
3. Highlight the desired entry, and select **Option > Add to Contacts**.

4. Edit the contact information.
5. Select **Save**.

## Saving a History Record to Blacklist

You can prevent someone from calling you again by saving a history record to Blacklist.

### Procedure

1. Select **History** or navigate to **Menu > History**.
2. Select the desired list.
3. Highlight the desired entry, and select **Option > Add to Blacklist**.
4. Edit the contact information.
5. Select **Save**.

## Deleting History Records

You can delete one or all call records from the call history list.

### Topics

[Deleting a Call Record](#)

[Deleting All Call Records](#)

## Deleting a Call Record

You can delete any call record from the call history list.

### Procedure

1. Press **History** or navigate to **Menu > History**.
2. Select the desired list.
3. Highlight the desired entry, and select **Delete**.

## Deleting All Call Records

You can delete all call records from the call history list.

### Procedure

1. Press **History** or navigate to **Menu > History**.
2. Select the desired list.
3. Select **Option > Delete All**.  
*The phone prompts you whether to delete all the records.*
4. Select **OK**.

## Disabling History Record

If you disable history record, you cannot save any call log on the phone.

### Procedure

1. Navigate to **Menu > Features > History Settings**.  
On the T29G phones, navigate to **Menu > Features > Others > General**.

2. Select **Disabled** from the **History Record** field.
3. Select **Save**.

---

# Customizing Your Phone

---

You can make your phone more personalized by customizing various settings.

## Topics

[Changing the Administrator Password](#)

[Wallpaper](#)

[Screen Saver](#)

[Changing the Backlight and Time](#)

[Adjusting the Screen Contrast](#)

[Changing the Language](#)

[Time & Date](#)

[Setting a Key as Send](#)

[Customizing the Soft Keys](#)

[Phone Lock](#)

[Extending the Line Key Labels](#)

## Changing the Administrator Password

By default, you require an administrator password to access the **Advanced/Advanced Settings** menu. The default password is "admin". For security reasons, you should change the default password as soon as possible.

### Note

If you do not change the default password, the phone displays a warning icon in the status bar.

### Procedure

1. Navigate to **Menu > Settings > Advanced Settings > Change Password**.  
On the T29G phones, navigate to **Menu > Advanced > Change Password**.
2. Enter your old and new password information.
3. Select **Save**.

### Related Topic

[Warnings](#)

## Wallpaper

You can change the background picture that is displayed on your phone.

The phone comes with a default background picture, you can change it to another built-in picture. You can also add personal pictures stored on a USB flash drive, or use a custom picture uploaded by your system administrator as the wallpaper.

Only T29G phones support wallpaper.

## Topics

[Changing Wallpaper on Idle Screen](#)

[Adding a Wallpaper from a USB Flash Drive](#)

## Changing Wallpaper on Idle Screen

You can set one of your pictures as the background image on your phone's idle screen.

### Procedure

1. Navigate to **Menu > Basic > Display > Wallpaper**.
2. Select the desired image.
3. Select **Save**.

## Adding a Wallpaper from a USB Flash Drive

You can use a picture that is stored on a USB flash drive as the background image of your phone.

We recommend that you add a picture less than 1.8 megapixels. Either the smaller or larger picture will be scaled proportionally to fit the screen.

### Before You Begin

Make sure that the picture is in the root directory of your USB flash drive, and the USB flash drive is connected to your phone successfully.

### Procedure

1. Navigate to **Menu > USB > Browse Photo**.
2. Highlight the desired picture, and select **Preview**.
3. Select **Set as > Set as wallpaper**.
4. Select **OK**.

*The phone background image will change to the selected picture.*

## Screen Saver

The screen saver starts automatically when your phone has been idle for the preset waiting time. You can stop the screen saver by pressing any key.

### Topics

[Changing the Waiting Time for Screen Saver](#)  
[Disabling Time & Date and Status Icons Display](#)  
[Adding a Screen Saver from a USB Flash Drive](#)  
[Setting the Screen Saver Type](#)

## Changing the Waiting Time for Screen Saver

You can set the waiting time after no activity before displaying the screen saver.

### Procedure

1. Navigate to **Menu > Settings > Basic Settings > Display > Screensaver**.  
On the T29G phones, navigate to **Menu > Basic > Display > Screensaver**.
2. Select the desired waiting time from the **Wait Time** field.
3. Select **Save**.

## Disabling Time & Date and Status Icons Display

For the T29G phones, you can disable your phone to display time, date and status icons on the screen saver.

The Time & Date and status icons display on the screen saver, as shown below:



#### Note

You cannot configure Time & Date and status icons display if your system administrator has set your phone to display custom information on the screen saver.

#### Procedure

1. Navigate to **Menu > Basic > Display > Screensaver**.
2. Select **Disabled** from the **Display Clock** field.
3. Select **Save**.

## Adding a Screen Saver from a USB Flash Drive

You can use a picture that is stored in your USB flash drive as the screen saver on your phone.

We recommend that you add a picture less than 1.8 megapixels. Either the smaller or larger picture will be scaled proportionally to fit the screen.

#### Before You Begin

Make sure that the picture is in the root directory of your USB flash drive, and the USB flash drive is connected to your phone successfully.

#### Procedure

1. Navigate to **Menu > USB > Browse Photo**.
2. Highlight the desired picture, and select **Preview**.
3. Select **Set as > Set as screensaver**.
4. Select **OK**.

## Setting the Screen Saver Type

The screen saver can start with different types and you can set it manually.

For the T29G phones, you can choose one of the following screen saver types:

- System
- Custom
- Server XML (shows custom information on the screen saver)

The T27G/T23P/T23G/T21(P) E2/T19(P) E2 phones can only display custom information that is preset by your system administrator as the screen saver.

#### Before You Begin

If you want to set a custom picture as the screen saver, make sure that the custom picture has been uploaded by your system administrator.

If you want to show custom information on the screen saver, make sure that the custom information has set by your system administrator.

### Procedure

1. Navigate to **Menu > Basic > Display > Screensaver**.
2. Select the desired screen saver type from the **Screensaver Type** field.
  - If you select **System**.  
The phone automatically set the built-in picture as the screen saver.
  - If you select **Custom**.  
The phone automatically set the custom pictures as the screen saver, and display these pictures alternately.
  - If you select **Server XML**.  
The phone automatically displays the custom information (for example, notifications or company logo) on the screen saver.
3. Select **Save**.

## Changing the Backlight and Time

You can change the brightness of the phone screen during phone activity and inactivity. The brightness automatically changes after the phone has been idle for a specified time. It is not available for the T19(P) E2 phone.

You can change the screen backlight and time in the following settings:

**Active Level:** The brightness level of the phone screen when the phone is active. Digits 1 to 10 represent different brightness levels. 10 is the brightest level. It is only available for the T29G/T27G phones.

**Inactive Level:** The brightness of the phone screen when the phone is inactive. You can select a low brightness or turn off the backlight. It is only available for the T29G phones.

**Backlight Time:** The delay time to change the brightness of the phone screen when the phone is inactive. Backlight time includes the following settings:

- **Always On:** Backlight is on permanently.
- **Always Off:** Backlight is off permanently. It is not available for the T29G phone.
- **15s, 30s, 1min, 2min, 5min, 10min or 30min:** Backlight is changed when the phone is inactive after the designated time.

### Procedure

1. Navigate to **Menu > Settings > Basic Settings > Display > Backlight**.  
On the T29G phones, navigate to **Menu > Basic > Display > Backlight**.
2. On the T29G/T27G phones, select the desired level from the **Active Level** field.
3. On the T29G/T27G phones, select the desired level from the **Inactive Level** field.
4. Select the desired time from the **Backlight Time** field.
5. Select **Save**.

## Adjusting the Screen Contrast

You can adjust the screen contrast of the phone to make it easier to read.

The intensity of screen contrast ranges from 1 to 10 and the highest intensity is 10. It is not available on the T29G phones.

#### Procedure

1. Navigate to **Menu > Settings > Basic Settings > Display > Contrast**.
2. Select the desired value from the **Contrast** field.
3. Select **Save**.

## Changing the Language

Your phone supports several languages that you can choose to use on the phone.

Contact your system administrator to find out exactly which languages are supported on your phone.

#### Procedure

1. Navigate to **Menu > Settings > Basic Settings > Language**.  
On the T29G phones, navigate to **Menu > Basic > Language**.
2. Select the desired language.
3. Select **Save**.

*The phone language is changed to the selected one.*

## Time & Date

You can set the time and date manually. The time and date formats are also variable.

#### Topics

[Setting the Time and Date Manually](#)

[Changing the Time and Date Format](#)

## Setting the Time and Date Manually

If your phone cannot obtain the time and date automatically, you can set it manually.

#### Procedure

1. Navigate to **Menu > Settings > Basic Settings > Time & Date > Manual Settings**.  
On the T29G phones, navigate to **Menu > Basic > Time & Date > General > Manual Settings**.
2. Edit the date and time.  
On the T29G phones, you can also press the up or down navigation key to select the desired date and time.
3. Select **Save**.

*The time and date set on the phone will be changed accordingly.*

## Changing the Time and Date Format

You can set the phone to display the time in 12-hour format or 24-hour format. You can also change the date format, including the options to display the day (D), month (M), and year (Y).

#### Note

Your system administrator can customize the date format.

#### Procedure



1. Navigate to **Menu > Settings > Basic Settings > Time & Date > Time & Date Format**.  
On the T29G phones, navigate to **Menu > Basic > Time & Date > Time & Date Format**.
2. Select the desired time format or date format.
3. Select **Save**.

## Setting a Key as Send

The pound key (#) is used as the send key by default. To type a phone number followed by the pound key (#), you can set the send key to the star key (\*).

You can also disable “#” and “\*” to be used as the send key.

### Procedure

1. Navigate to **Menu > Features > Key As Send**.  
On the T29G phones, navigate to **Menu > Features > Others > General**.
2. Select the desired value from the **Key As Send** field.
3. Select **Save**.

## Customizing the Soft Keys

You can customize the function of the soft keys displayed on the bottom of the idle screen for all IP phones except the T29G phones.

The soft keys are typically used to access frequently used functions, and to create menu shortcuts to access frequently used phone settings. The soft keys perform the same functions as the hard keys.

### Caution

We recommend that you keep a **Menu** soft key, otherwise you cannot access the phone settings.

### Procedure

1. Navigate to **Menu > Settings > Advanced Settings** (default password: admin) > **Softkey Label**.
2. Select the desired soft key.
3. Select the desired key type from the **Type** field.
4. (Optional.) Select the desired line from the **Account ID** field.
5. (Optional.) Enter the string that will appear on the phone screen in the **Label** field.
6. (Optional.) Enter the corresponding value in the **Value** field.
7. Select **Save**.

## Phone Lock

Phone lock helps you protect your phone from unauthorized use.

### Topics

[Setting the Phone Lock](#)

[Locking Your Phone Manually](#)

[Unlocking Your Phone](#)

[Changing Your Phone Unlock PIN](#)

## Setting the Phone Lock



You can manually lock the phone or wait a specified time to automatically lock the phone.

What unauthorized users can do depends on the settings of the phone lock type.

The phone supports the following phone lock types:

- **Menu key:** it prevents unauthorized users from accessing the menu, changing the personal settings for your phone.
- **Function key:** it only allows users to use the keypad for placing a call, answering or rejecting an incoming call and ending a call, and it prevents unauthorized users from other operations.
- **All keys:** it only allows users to use the keypad for dialing an emergency number or authorized numbers that set up by your system administrator, answering or rejecting an incoming call and ending a call, and it prevents unauthorized users from other operations. The phones only support All Keys type of phone lock.

### Note

The Volume key , HEADSET key and Speakerphone key  are always available when you lock the phone.

### Procedure

1. Navigate to **Menu > Settings > Basic Settings > Phone Lock**.  
On the T29G phones, navigate to **Menu > Basic > Phone Lock**.
2. Enter the desired PIN (default PIN: 123) in the **Unlock PIN** field.
3. Select **OK**.
4. Select **Enabled** from the **Lock Enable** field.
5. Select the desired type from the **Lock Type** field.
6. Enter the desired interval (0 - 3600 seconds) in the **Auto Lock** field.  
If the value is set to 0, the phone will not be automatically locked.
7. Select **Save**.

## Locking Your Phone Manually

You can lock the phone manually before the phone is automatically locked.

### Before You Begin

Make sure that the phone lock is set.

### Procedure

1. Long press # key when the phone is idle.  
*The lock icon appears on the phone screen.*

### Related Topic

[Setting the Phone Lock](#)

## Unlocking Your Phone

You can use an unlock PIN to unlock the phone.

If you forget the unlock PIN, you can enter the administrator password to unlock your phone, and then automatically access the PIN change screen.

### Procedure

1. Press any locked key, the phone prompts you to enter an unlock PIN.

2. Enter the desired PIN (default: 123) in the **Unlock PIN** field.
3. Select **OK**.

*The lock icon disappears from the phone screen.*

## Changing Your Phone Unlock PIN

The default unlock PIN is "123". For security reasons, you should change the default unlock PIN as soon as possible.

### Procedure

1. Navigate to **Menu > Settings > Basic Settings > Change PIN**.  
On the T29G phones, navigate to **Menu > Basic > Change PIN**.
2. Enter your old and new unlock PIN respectively.  
The unlock PIN length must be within 15 digits.
3. Select **Save**.

## Extending the Line Key Labels

On the T27G phones, you can extend the line key labels to the half of the phone screen when the phone is idle or during the call.

### Procedure

1. Navigate to **Menu > Features > Dsskey**.
2. Select the desired line key.
3. Select **Key Event** from the **Type** field.
4. Select **Extend** from the **Key Type** field.
5. (Optional.) Enter the string that will appear on the phone screen in the **Label** field.
6. Select **Save**.
7. When the phone is idle/during the call, press the Extend key to extend the line key labels.

### Note

During the call, the phone automatically exits the Extended Dsskey screen within 1 minute if there is no operation. When the phone is idle, you need to press the Extend key again to exit the Extended Dsskey screen.

## Audio Settings

You can change the basic audio settings on your phone.

### Topics

[Adjusting the Volume](#)

[Setting the Ring Tone](#)

[Disabling the Key Tone](#)

## Adjusting the Volume

You can adjust the volume of the ringer, media, and the audio during a call.

### Procedure

1. Press the Volume key  to adjust the volume.

## Setting the Ring Tone

You can set distinctive ring tones for groups or contacts in your Local Directory so that you can identify the caller when your phone rings.

The ring tones are used according to this priority: Contact ring tone>Group ring tone>Account ring tone >Phone ring tone.

### Topics

[Setting a Ring Tone for the Phone](#)

[Setting a Ring Tone for an Account](#)

[Setting a Ring Tone for a Group](#)

[Setting a Ring Tone for a Contact](#)

## Setting a Ring Tone for the Phone

You can choose a ring tone for all incoming calls.

### Procedure

1. Navigate to **Menu > Settings > Basic Settings > Sound > Ring Tones > Common**.  
On the T29G phones, navigate to **Menu > Basic > Sound > Ring Tones > Common**.
2. Select the desired ring tone.
3. Select **Save**.

## Setting a Ring Tone for an Account

You can select a unique ring tone for an individual account.

### Procedure

1. Navigate to **Menu > Settings > Basic Settings > Sound > Ring Tones**.  
On the T29G phones, navigate to **Menu > Basic > Sound > Ring Tones**.
2. Select the desired account.
3. Select the desired ring tone.

*If **Common** is selected, this account will use the ring tone selected for the phone.*

4. Select **Save**.

## Setting a Ring Tone for a Group

You can select a unique ring tone for various groups in your Local Directory.

### Note

You can only set a ring tone for a group that is added manually.

### Procedure

1. Select **Directory (Dir)** or navigate to **Menu > Directory > Local Directory**.
2. Highlight the desired group.
3. Select **Option > Detail**.
4. Select the desired ring tone from the **Ring** field.

If **Auto** is selected, this group uses the ring tone according to the default priority.

*If a specific ring tone is selected, this group uses the ring tone according to the priority: Contact ring tone>Group ring tone.*

5. Select **Save**.

## Setting a Ring Tone for a Contact

You can select a unique ring tone for various contacts in your Local Directory. This helps you quickly identify callers according to the ring tones.

### Procedure

1. Select **Directory (Dir)** or navigate to **Menu > Directory > Local Directory**.
2. Select the desired contact group or **All Contacts**.
3. Highlight the desired contact, and select **Option > Detail**.
4. Select the desired ring tone from the **Ring** field.

*If **Auto** is selected, the contact uses the ring tone according to the default priority.*

5. Select **Save**.

## Disabling the Key Tone

If you disable the key tone, the phone will not produce a sound when pressing the keypad keys.

### Procedure

1. Navigate to **Menu > Settings > Basic Settings > Sound > Key Tone**.  
On the T29G phones, navigate to **Menu > Basic > Sound > Key Tone**.
2. Select **Disabled** from the **Key Tone** field.
3. Select **Save**.

## Optional Accessories with Your Phone

The phone can use optional accessories when you need to extend your phone's capabilities.

The following optional accessories need to be purchased separately if required for your phone:

- Headset YHS33/UH33
- Wireless Headset Adapter EHS36/EHS40
- Bluetooth USB Dongle BT40/BT41
- Wi-Fi USB Dongle WF40/WF50
- Expansion Module EXP20

Check with your system administrator to find out which of these applications or accessories are available on your phone.

### Caution

We recommend that you use the accessories provided or approved by Yealink. The use of unapproved third-party accessories may result in poor performance.

### Topics

[Headset](#)

[Bluetooth](#)

[Wireless Network](#)

[Expansion Module and Your Phone](#)

## Headset

The phone supports wired or wireless headset, USB headset and Bluetooth headset to place and answer calls.

Not all phones support all types of the headsets, different headset have different supported phone models.

Handset	Supported Phone Models
Analog Headset	All phones
USB Headset	T29G/T27G phones
Bluetooth Headset	T29G/T27G phones
Wireless Headset	All phones

You can use only one headset at a time. The headset is used according to the priority: USB headset/Bluetooth headset>YHS33/UH33/wireless headset.

### Note

Your system administrator can disable the headset feature. Check with your system administrator to find out if it is available on your phone.

### Topics

[Connecting the Analog Headset](#)

[Wireless Headset](#)

[Bluetooth Headset](#)

[USB Headset](#)

[Using Headsets](#)

## Connecting the Analog Headset

If you want to use an analog headset, you require an optional headset YHS33/UH33.

### Procedure

1. Simply insert the headset connector into the headset port on the back of your IP phone.

## Wireless Headset

You can use most wireless headsets with your phone.

EHS36/EHS40 provides the technical interface between your phone and an EHS-compatible wireless headset, such as Sennheiser/Jabra (GN Netcom) or Plantronics headset. After the EHS36/EHS40 and your headset are connected successfully, you can handle calls by your headset.

For more information on how to connect EHS36/EHS40, see the EHS36 User Guide/EHS40 User Guide on [Yealink Technical Support](#) page. For more information on how to use your headset, see your headset documentation from the manufacturer.

## Bluetooth Headset

You can use a Bluetooth headset to handle calls on the T29G/T27G phones.

For more information, refer to the documentation from your Bluetooth headset manufacturer.

### Related Topics

[Pairing and Connecting the Bluetooth Headset](#)

[Deleting the Paired Bluetooth Device](#)

[Disconnecting the Bluetooth Device](#)

[Connecting the Analog Headset](#)

## USB Headset

You can use a USB headset to handle calls on the T29G/T27G phones.

For the information on how to connect a USB headset, see the Quick Start Guide for your phone on [Yealink Support](#).

For a list of supported USB headsets, refer to [Tested headset list compatible with Yealink IP Phone](#) for your IP phones on [Yealink Support](#). USB headsets that are not listed may not function properly if you connect them to your phone.

For more information on how to use your USB headset, refer to the related documentation from the manufacturer.

## Using Headsets

After connecting a headset to your phone, you can activate the headset mode and use the headset when answering and placing calls. If you do not want to use a headset to handle calls, you can deactivate the headset mode.

### Procedure

1. Press the HEADSET key on the phone.  
*The headset icon appears on the phone screen.*
2. Press the HEADSET key again on the phone.  
*The headset icon disappears from the phone screen.*

### Note

You can initiate or end calls by pressing the HEADSET key. Check with your system administrator to find out if it is available on your phone.

## Related Topics

[Switching Among the Handset, Speakerphone and Headset Modes](#)

[Placing Calls](#)

[Answering Calls](#)

## Bluetooth

When the Bluetooth mode is activated, you can pair and connect your Bluetooth device to the phone.

You can scan and pair up to 60 Bluetooth devices with your phone. However, only one device can be connected at a time. If you connect your Bluetooth-enabled mobile phone to the phone, you can synchronize the mobile contacts to the phone.

The T29G/T27G phones support Bluetooth.

### Topics

[Activating the Bluetooth Mode](#)

[Pairing and Connecting the Bluetooth Headset](#)

[Pairing and Connecting the Bluetooth-enabled Mobile Phone](#)

[Syncing the Mobile Contacts to the Phone](#)

[Viewing the Bluetooth Device Information](#)

[Editing Device Name of Your Phone](#)

[Deleting the Paired Bluetooth Device](#)

[Disconnecting the Bluetooth Device](#)

[Deactivating the Bluetooth Mode](#)

## Activating the Bluetooth Mode

You should activate the Bluetooth mode first when you need to connect the Bluetooth device to your phone.

### Procedure

1. Insert the Bluetooth USB dongle into the USB port on the back of the phone.

*The phone prompts you whether to scan the Bluetooth devices right now.*

2. Select **OK**.

3. Select **On** from the **Bluetooth** field.

4. Select **Save**.

*The phone scans the available Bluetooth devices automatically.*

## Pairing and Connecting the Bluetooth Headset

When you need the Bluetooth headset to handle calls, you should pair and connect it to your phone in advance.

### Before You Begin

Make sure that the Bluetooth headset is discoverable.

### Procedure

1. Navigate to **Menu > Settings > Basic Settings > Bluetooth**.

On the T29G phones, navigate to **Menu > Basic > Bluetooth**.

2. Select **Scan** to search the Bluetooth devices.

*The phone proceeds to scan the local Bluetooth devices, and phone screen displays the available Bluetooth devices.*



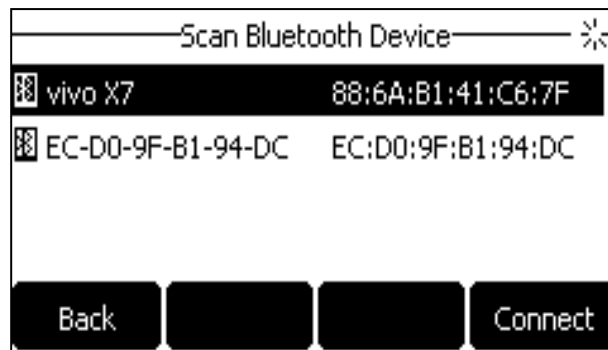

- Find your Bluetooth headset, and select **Connect**.

*The Bluetooth icon appears on the phone screen.*

#### Related Topic

[Activating the Bluetooth Mode](#)

## Pairing and Connecting the Bluetooth-enabled Mobile Phone

After pairing and connecting the Bluetooth-enabled mobile phone, you can use the sync feature.

#### Before You Begin

Make sure that the Bluetooth-enabled mobile phone is discoverable.

#### Procedure

- Navigate to **Menu > Settings > Basic Settings > Bluetooth**.  
On the T29G phones, navigate to **Menu > Basic > Bluetooth**.
- Select **Scan** to search for the Bluetooth-enabled mobile phone.
- Find your Bluetooth-enabled mobile phone, and then select **Connect**.  
*The phone will prompt the connection passkey on the phone screen.*
- Make sure your mobile phone is showing the same passkey, and then select **OK** on both mobile phone and phone.
- (Optional.) Select **OK** to enable the mobile contacts sync feature, or select **Cancel** to disable mobile contacts sync feature.

#### Note

If you enable mobile contacts sync feature, you also need to authorize the phone to sync the contacts temporarily on the mobile phone.

#### Related Topics

[Activating the Bluetooth Mode](#)

[Syncing the Mobile Contacts to the Phone](#)

## Syncing the Mobile Contacts to the Phone

You can sync mobile contacts to your phone. This is a convenient way to view a contact without accessing your mobile phone.

#### Topics

[Enabling the Mobile Contacts Sync Feature](#)

[Viewing Your Mobile Contacts on the Phones](#)

[Disabling the Mobile Contacts Sync Feature](#)

## Enabling the Mobile Contacts Sync Feature

To sync the mobile contacts to the phone, you should enable the sync feature in advance.

### Before You Begin

Make sure that the Bluetooth-enabled mobile phone is paired and connected to your phone.

### Procedure

1. Navigate to **Menu > Settings > Basic Settings > Bluetooth > Paired Bluetooth Device**.  
On the T29G phones, navigate to **Menu > Basic > Bluetooth > Paired Bluetooth Device**.
2. Select **Option > Detail**.
3. Select **On** from the **Mobile Contacts Sync** field.

*You need to authorize the phone to synchronize the contacts temporarily on the mobile phone first, and then the mobile contacts directory will appear in the phone directory list.*

### Related Topic

[Pairing and Connecting the Bluetooth-enabled Mobile Phone](#)

## Viewing Your Mobile Contacts on the Phones

You can view a list of mobile contacts on the phone.

### Before You Begin

Make sure that the mobile contact sync feature is enabled.

### Procedure

1. Navigate to **Menu > Directory > Mobile Contacts**.

*The contacts stored in your mobile phone will display in the **Mobile Contacts** list.*

### Related Topic

[Enabling the Mobile Contacts Sync Feature](#)

## Disabling the Mobile Contacts Sync Feature

When you no longer view and use the mobile contacts on the phone, you can disable the sync feature.

### Procedure

1. Navigate to **Menu > Settings > Basic Settings > Bluetooth > Paired Bluetooth Device**.  
On the T29G phones, navigate to **Menu > Basic > Bluetooth > Paired Bluetooth Device**.
2. Select **Option > Detail**.
3. Select **Off** from the **Mobile Contacts Sync** field.

*The mobile contacts directory disappears from the phone directory list.*

### Tip

The mobile contacts directory also disappears from the phone directory list after deactivating the Bluetooth mode.

### Related Topic

[Deactivating the Bluetooth Mode](#)

## Viewing the Bluetooth Device Information

You can view the Bluetooth device information when the Bluetooth mode is activated.

### Before You Begin

Make sure that the Bluetooth mode is activated and the Bluetooth device has been paired on your phone.

### Procedure

1. Navigate to **Menu > Settings > Basic Settings > Bluetooth**.  
On the T29G phones, navigate to **Menu > Basic > Bluetooth > Paired Bluetooth Device**.
2. Select the desired Bluetooth device. Select **Option > Detail** to view the Bluetooth device information:
  - **Device Name:** the name of the Bluetooth device.
  - **MAC:** the MAC address of the Bluetooth device.
  - **Mobile Contacts Sync:** mobile contacts synchronization when the Bluetooth-enabled mobile phone is connected.

### Related Topics

[Activating the Bluetooth Mode](#)

[Pairing and Connecting the Bluetooth-enabled Mobile Phone](#)

## Editing Device Name of Your Phone

You can edit the device name of your phone for easily recognizable.

### Before You Begin

Make sure that the Bluetooth mode is activated.

### Procedure

1. Navigate to **Menu > Settings > Basic Settings > Bluetooth > Edit My Device Information**.  
On the T29G phones, navigate to **Menu > Basic > Bluetooth > Edit My Device Information**.  
*The phone screen displays the device name.*
2. Enter the desired name in the **Device Name** field.
3. Select **Save**.

### Related Topic

[Activating the Bluetooth Mode](#)

## Deleting the Paired Bluetooth Device

You can delete the Bluetooth device paired from your phone, the next time you activate the Bluetooth mode, the phone will not automatically connect to this device.

### Procedure

1. Navigate to **Menu > Settings > Basic Settings > Bluetooth > Paired Bluetooth Device**.  
On the T29G phones, navigate to **Menu > Basic > Bluetooth > Paired Bluetooth Device**.
2. Select **Option > Delete**.  
*The phone prompts you whether to delete the device.*
3. Select **OK**.

## Disconnecting the Bluetooth Device

You can disconnect your Bluetooth device from your phone. When you disconnect a Bluetooth device, it remains paired and you can reconnect it to your phone.

### Procedure

1. Navigate to **Menu > Settings > Basic Settings > Bluetooth > Paired Bluetooth Device**.  
On the T29G phones, navigate to **Menu > Basic > Bluetooth > Paired Bluetooth Device**.
2. Highlight the connected Bluetooth device and select **Disconnect**.

### Tip

You can quickly disconnect your Bluetooth headset by turning your headset off.

## Deactivating the Bluetooth Mode

After you deactivate the Bluetooth mode, the Bluetooth device will disconnect from your phone, but it remains paired and you can reconnect it to your phone.

### Procedure

1. Navigate to **Menu > Settings > Basic Settings > Bluetooth**.  
On the T29G phones, navigate to **Menu > Basic > Bluetooth**.
2. Select **Off** from the **Bluetooth** field.
3. Select **Save**.

## Wireless Network

You can connect the T29G/T27G phones to a wireless network if Wi-Fi is available within the area. For more information, contact your system administrator.

### Topics

[Activating the Wi-Fi Mode](#)

[Connecting to the Wireless Network](#)

[Viewing the Wireless Network Information](#)

[Managing the Saved Wireless Network](#)

[Disconnecting the Wireless Network Connection](#)

[Deactivating the Wi-Fi Mode](#)

## Activating the Wi-Fi Mode

You can activate the Wi-Fi mode to connect your phone to an available wireless network.

### Procedure

1. Insert the Wi-Fi USB dongle into the USB port on the back of the phone.  
*The phone prompts you whether to scan the Wi-Fi devices right now.*
2. Select **OK**.
3. Select **On** from the **Wi-Fi** field.
4. Select **Save**.

*The phone scans the available wireless networks in your area.*

## Connecting to the Wireless Network

After you have activated the Wi-Fi mode, you can connect the phone to the wireless network.

### Topics

[Connecting to an Available Wireless Network Manually](#)

[Connecting to the Wireless Network Using WPS](#)

[Adding a Wireless Network Manually](#)

## Connecting to an Available Wireless Network Manually

When you enable the Wi-Fi mode, the phone automatically connects to the saved wireless network, you can also connect it manually.

### Before You Begin

Get the password of the wireless network from your system administrator. Make sure that the Wi-Fi mode is activated.

### Procedure

1. Navigate to **Menu > Settings > Basic Settings > Wi-Fi**  
On the T29G phones, navigate to **Menu > Basic > Wi-Fi**
2. Highlight the **X Available Network(s)** (X represents the number of available networks), and select **Enter**.
3. (Optional.) To research the available network, select **Scan**.
4. Highlight the desired wireless network and select **Connect**.
5. If the network is secure, enter its password.
6. Select **OK**.

### Related Topic

[Activating the Wi-Fi Mode](#)

## Connecting to the Wireless Network Using WPS

The Wi-Fi protected setup (WPS) provides simplified mechanisms to configure secure wireless networks which can automatically configure a wireless network with a network name (SSID) and strong WPA data encryption and authentication.

There are two supported methods in the Wi-Fi protected setup:

- **Push Button Configuration (PBC):** The user simply has to press the WPS key on both the phone and gateway/router to connect.
- **Personal Identification Number (PIN):** The user enters the PIN generated randomly by the phone on the gateway/router to connect.

### Before You Begin

Make sure that the Wi-Fi mode is activated.

### Procedure

1. Navigate to **Menu > Settings > Basic Settings > Wi-Fi**  
On the T29G phones, navigate to **Menu > Basic > Wi-Fi**
2. Do one of the following:
  - Select **WPS > WPS** to use the PBC method, then long press the WPS key on your gateway or router.  
*Once the WPS setup has completed successfully, the phone screen will prompt "Connect Success."*

- Select **WPS > WPS-PIN** to use the PIN method, then log into your gateway or router's web interface, and configure it to search the clients. For more information, refer to the documentation from the gateway or router manufacturer.

*Once WPS-PIN setup has completed successfully, the web interface of the gateway or router will prompt the connection is successful.*

### Related Topic

[Activating the Wi-Fi Mode](#)

## Adding a Wireless Network Manually

If SSID broadcast on your gateway or router is disabled, the wireless network might not appear in the scanning results. In that case, you must manually add a wireless network.

The phone can store up to 5 connected wireless networks.

### Before You Begin

Get the available wireless network information from your system administrator. Make sure that the Wi-Fi mode is activated.

### Procedure

1. Navigate to **Menu > Settings > Basic Settings > Wi-Fi**  
On the T29G phones, navigate to **Menu > Basic > Wi-Fi**
2. Highlight **Known Network(s)**, and select **Add**.
3. Do the following:
  - If you select **None** or **WEP** from the **Security Mode** field, enter the desired values in the corresponding fields.
  - If you select **WPA-PSK**, **WPA2-PSK**, **WPA-EAP** or **WPA2-EAP** from the **Security Mode** field, select the desired cipher type first and enter the desired values in the corresponding fields.
4. Select **Save**.

*The connected wireless networks will be saved to the **Known Network(s)** list.*

### Related Topic

[Activating the Wi-Fi Mode](#)

## Viewing the Wireless Network Information

You can view the wireless network information (for example, Profile Name, SSID or Signal Strength) when the Wi-Fi mode is activated.

### Procedure

1. Navigate to **Menu > Settings > Basic Settings > Wi-Fi > X Available Network(s)** (X represents the number of available networks).  
On the T29G phones, navigate to **Menu > Basic > Wi-Fi > X Available Network(s)**.
2. Select **Detail** to view the detailed wireless network information.  
If the phone is connected to a wireless network successfully, you can also navigate to **Menu > Settings > Basic Settings > Wi-Fi > Wi-Fi Status** to view the connected wireless network information.

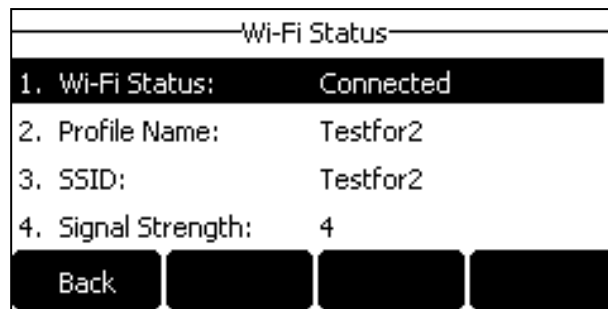

## Managing the Saved Wireless Network

You can edit, reorder and delete the saved wireless network.

Once the phone has been connected to a wireless network successfully, this wireless network profile will be saved in **Known Network(s)** list. Next time you activate Wi-Fi mode, the phone will be automatically connected to the wireless network which has the highest priority (the top one).

Up to 5 wireless network profiles can be saved in **Known Network(s)** list. If you want to add a new one when the phone has already saved 5 wireless network profiles, delete an older one before adding.

### Procedure

1. Navigate to **Menu > Settings > Basic Settings > Wi-Fi > Known Network(s)**.  
On the T29G phones, navigate to **Menu > Basic > Wi-Fi > Known Network(s)**.
2. Select **Option**.
3. Do one of the following:
  - Select **Edit** to edit the wireless network profile, and select **Save**.
  - Select **Move Up** or **Move Down** to change the priority of the wireless network.
  - Select **Delete** or **Delete All** to delete the saved wireless network profile.

## Disconnecting the Wireless Network Connection

When you no longer want to connect to the current wireless network, you can disconnect it.

### Procedure

1. Navigate to **Menu > Settings > Basic Settings > Wi-Fi**  
On the T29G phones, navigate to **Menu > Basic > Wi-Fi**
2. Select **X Available Network(s)** (X represents the number of available networks).
3. Highlight the connected wireless network, and select **Disconnect**.

### Tip

You can also disconnect the wireless network when deactivating the Wi-Fi mode.

### Related Topic

[Deactivating the Wi-Fi Mode](#)

## Deactivating the Wi-Fi Mode

You should deactivate the Wi-Fi mode when you need to connect your phone to the wired network.

### Procedure

1. Navigate to **Menu > Settings > Basic Settings > Wi-Fi**  
On the T29G phones, navigate to **Menu > Basic > Wi-Fi**
2. Select **Off** from the **Wi-Fi** field.
3. Select **Save**.

## Expansion Module and Your Phone

The expansion module EXP20 is a console you can use to connect to a phone to add additional Ext keys and expand the functions of your phone. Only T29G/T27G phone supports it.

For more information on expansion module EXP20, refer to the LCD Expansion Module EXP20 user guide on [Yealink Technical Support](#) page.

### Topics

[Connecting the Expansion Module](#)  
[Assigning the Features for Ext Keys](#)  
[Adjusting the Contrast of the Expansion Module](#)  
[Adjusting the Backlight of the Expansion Module](#)

## Connecting the Expansion Module

You can connect the expansion module to your phone, using the supplied materials in the expansion module's packaging.

### Procedure

1. Connect the expansion module to the phone using the connecting sheet and screws.
2. Connect the supplied cord from the Ext jack on the host phone to the Ext in jack on the expansion module.

For more detailed information about how to connect the expansion module, refer to the LCD Expansion Module quick start guide on the [Yealink Technical Support](#) page.

## Assigning the Features for Ext Keys

You can customize features for Ext keys on the connected phone.

### Procedure

1. Long press the desired Ext key on the expansion module.  
*The phone screen will enter the user setting interface of this key.*
2. Customize the specific feature for this key on the phone.
3. Select **Save**.

## Adjusting the Contrast of the Expansion Module

You can configure the contrast of the expansion module via the host phone to make it easier to read.

### Procedure

1. Navigate to **Menu > Settings > Basic Settings > Display > Contrast**.  
On the T29G phones, navigate to **Menu > Basic > Display > Contrast**.
2. Select the desired value between 1 and 10 (highest intensity) from the **Contrast** field.
3. Select **Save**.



## Adjusting the Backlight of the Expansion Module

When you change the backlight intensity settings on your T29G/T27G phones, the backlight on expansion module connected to your phone automatically changes to match the new settings.

### Related Topic

[Changing the Backlight and Time](#)

## Maintaining Your Phone

When your phone is unable to operate properly, you need to investigate or troubleshoot issues along with other tasks your system administrator may ask you to perform.

### Topics

[Warnings](#)

[Diagnosing the Network](#)

[Rebooting Your Phone](#)

[Resetting to Factory Settings](#)

[Updating the Phone Configuration](#)

[Clearing User's Personalized Configuration Settings](#)

## Warnings

When some issues occur on your phone, on the T27G/T23P/T23G/T21(P) E2/T19(P) E2 phones, a warning icon appears in the status bar.

The following lists the detailed situations:

- The default password is being used
- Failed to register the account
- Provisioning credentials are wrong
- Network is unavailable

### Topics

[Investigating Warnings](#)

[Re-provisioning Your Phone](#)

[Clearing Warnings](#)

### Related Topic

[Changing the Administrator Password](#)

## Investigating Warnings

The warning icon lets you know that your phone has one or more important issues. You can view details about warnings on the **Status** screen.

### Procedure

1. Navigate to **Menu** > **Status**.
2. Select **Warnings**.

*The **Warnings** screen is displayed listing any issues.*

### Tip

You can also press the **OK** key when the phone is idle, and then select **Warnings**.

## Re-provisioning Your Phone

When the provisioning credentials are wrong, you need to ask your system administrator for the valid provisioning credentials to re-provision your phone.

**Procedure**

1. Navigate to **Menu > Status > Warnings**.
2. Select **Auto-p credentials failed > Re Provision**.
3. Enter valid provisioning credentials, and select **Save**.

*The phone prompts you whether to provision now.*

4. Select **OK**.

## Clearing Warnings

You can temporarily remove the warning icon from the status bar.

However, the warning icon appears again after the phone reboots or the phone has a new warning if the issue is not solved.

**Procedure**

1. Navigate to **Menu > Status > Warnings**.
2. Select **Clear Icon**.

## Diagnosing the Network

When network problems occur on your phone, you can use the "ping" or "trace route" method to troubleshoot network connectivity problems.

**Procedure**

1. Navigate to **Menu > Features > Diagnostics > Network**.
2. Do one of the following:
  - Select **Ping**, then enter the desired IP address or URL in the **Ping IP or URL** field.
  - Select **Trace Route**, then enter the desired IP address or URL in the **Trace Route IP or URL** field.
3. Select **Start**.

*The screen displays the network status information.*

## Rebooting Your Phone

The improper operation may cause malfunction. If the malfunction occurs, your system administrator may ask you to reboot your phone.

**Procedure**

1. Navigate to **Menu > Settings > Basic Settings > Reboot**.  
On the T29G phones, navigate to **Menu > Basic > Reboot**.

*The phone prompts you whether to reboot the phone.*

2. Select **OK**.

**Tip**

You can also long press the Cancel key on the keypad when the phone is idle to reboot the phone.

## Resetting to Factory Settings

When some issues occur on your phone and you have tried all troubleshooting suggestions but still do not solve the problem, you can reset your phone to factory configurations.

This operation will delete all your personal configuration settings, and reset all settings to the factory defaults. Check with your system administrator if the personalized settings are kept before resetting your phone to factory settings.

### Procedure

1. Navigate to **Menu > Settings > Advanced Settings** (default password: admin) > **Reset Config**.  
On the T29G phones, navigate to **Menu > Advanced** (default password: admin) > **Reset Config**.
2. Select **Reset to Factory Settings > Reset**.  
*The phone prompts you whether to reset the setting.*
3. Select **OK**.  
*The phone begins resetting.*

### Tip

You can also long press the OK key when the phone is idle.

*After reset, the screen prompts "Welcome Initializing...Please wait".*

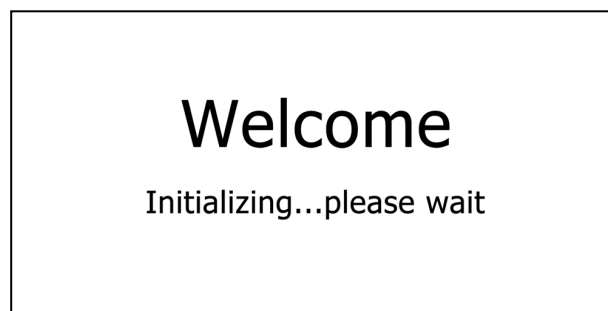

*The phone will be reset successfully after startup.*

### Note

Reset of your phone may take a few minutes. Do not power off until the phone has started up successfully.

## Updating the Phone Configuration

Your system administrator may ask you to update the configuration for your phone to apply any changes to system settings, which you can do without restarting it.

### Procedure

1. Navigate to **Menu > Settings > Basic Settings > Update Configuration**.  
On the T29G phones, navigate to **Menu > Basic > Update Configuration**.  
*A message is displayed on the phone screen:*

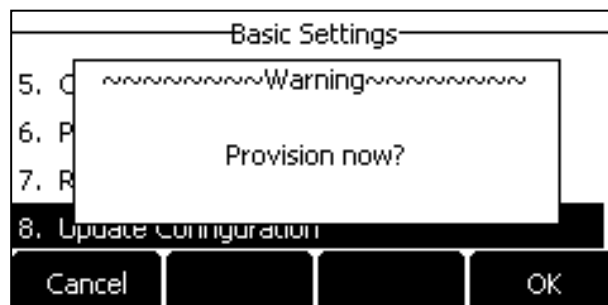

2. Select **OK**.

### Tip

You can also long press the RD key when the phone is idle to update the phone configuration.

## Clearing User's Personalized Configuration Settings

You can clear the personalized configuration settings manually on the phone.

### Before You Begin

Your system administrator has enabled the phone to keep the user's personalized settings after auto provisioning.

### Procedure

1. Navigate to **Menu > Settings > Basic Settings > Reset local settings**.

*The phone prompts you whether to reset the local settings.*

2. Select **OK**.

# Appendix - Menu Structure

## For the T29G Phone

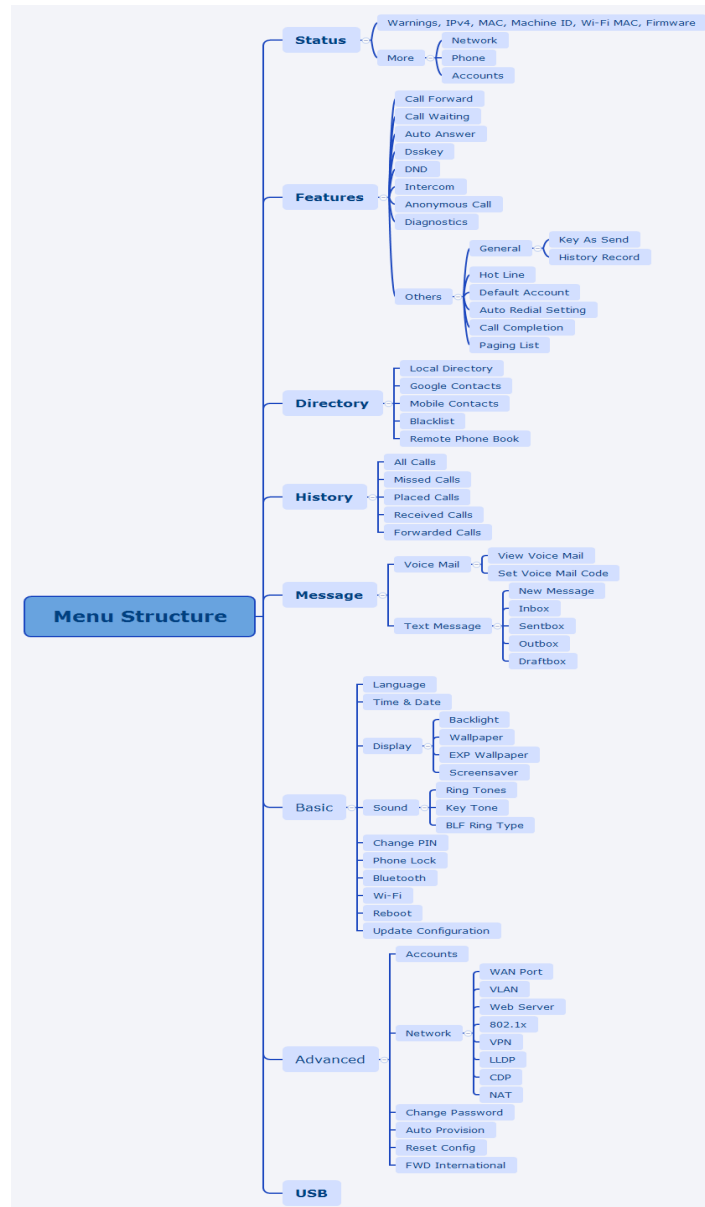

## For the T27G/T23P/T23G/T21(P) E2/T19(P) E2 Phone

