

Panasonic[®]

Operating Instructions

SIP Phone



<KX-UTG200>

Model No.

KX-UTG200

Thank you for purchasing this Panasonic product.
Please read this manual carefully before using this product and save this manual for future use.

KX-UTG200: Software File Version 1.131 or later

Document Version: 2014-04

Introduction

Feature Highlights

Easy Operation

You can easily access features using the Navigator key, fixed buttons, and soft buttons. Also, the Message/Ringer lamp will inform you when you have an incoming call or a message waiting.

High-quality Voice Communication

This unit supports the standard SIP protocol and the G.722 codec, enabling reliable and high-quality voice communication.

ECO Mode

Enabling ECO mode allows you to use this unit while reducing the amount of electricity consumed (Page 43).

Compatible with Electric Hook Switch (EHS) Headsets

This unit supports EHS headsets (Page 56).

Outline

This manual describes information about the installation and operation of the unit.

Related Documentation

Getting Started

Briefly describes basic information about the installation of the unit.

Administrator Guide

Describes information about the programming and maintenance of the unit.

Manuals and supporting information are provided on the Panasonic Web site at:
<http://www.panasonic.com/sip>

Note

- The contents and design of the software are subject to change without notice.

Other Information

Trademarks

- Plantronics is a trademark or registered trademark of Plantronics, Inc.
- Jabra is a registered trademark of GN Netcom A/S.
- All other trademarks identified herein are the property of their respective owners.

When you ship the product

Carefully pack and send it prepaid, adequately insured and preferably in the original carton. Attach a postage-paid letter, detailing the symptom to the outside of the carton.

DO NOT send the product to the Executive or Regional Sales offices. They are NOT equipped to make repairs.

Product Service

Panasonic factory service centers for this product are listed in the service center directory.

Consult your authorized Panasonic dealer for detailed instructions.

For Future Reference

Record the information in the space below for future reference.

Note

- The serial number and MAC address of this product may be found on the label affixed to the bottom of the unit. You should note the serial number and MAC address of this unit in the space provided and retain this manual as a permanent record of your purchase to aid in identification in the event of theft.

MODEL NO.	_____
SERIAL NO.	_____
MAC ADDRESS	_____
DATE OF PURCHASE	_____
NAME OF DEALER	_____
DEALER'S ADDRESS	_____

DEALER'S TEL. NO.	_____

Table of Contents

Important Information	7
Data Security	7
Additional Information	8
Before Operating the Telephone	9
Accessory Information	9
Location of Controls	10
Screens	13
Icons	15
Soft Buttons and Soft Button Icons	17
Basic Operations	19
Confirming Your Extension Number	19
Going off- and on-hook	19
Adjusting the Volume	19
Feature Operations	20
Making Calls	20
Making a Call	20
Making a Call from the Phonebook List	20
Dialing by Using Call Logs	20
Redialing the Last Number You Dialed (Redial, Last Number)	20
One-touch Dialing	21
Intercom	21
Multicast Paging (Push To Talk)	21
Receiving Calls	22
Receiving a Call	22
Rejecting Calls	22
Ignoring Calls	23
Holding a Call	23
Receiving a Second Call (Answering Call Waiting)	24
Talking to Two Parties Alternately (Call Splitting)	24
Transferring a Call (Call Transfer)	25
To Transfer with a Flexible Button	25
Mute	25
Conference Call	26
Making a Conference Call	26
Removing a Party from the Conference	26
Ending a Conference Call	26
Checking Messages	26
Checking New Messages	26
Checking Missed Calls	27
Erasing All Call Logs in a Log Category	27
Call Forwarding/Do Not Disturb	27
Optional Group Features	28
SCA (Shared Call Appearance)	28
Services	28
Flexible Buttons	29
IM&P (Instant Messaging & Presence)	31
Logging in to IM&P	31
Presence	32
Contacts	32
Sending Messages to Contacts	33

Calling Contacts	33
Making Conference Calls	33
Customizing the Telephone	34
Phonebook List	34
Adding a New Phonebook Entry	34
Adding a Phonebook Entry from the Call Log	34
Editing a Phonebook Entry	34
Searching for a Phonebook Entry	35
Deleting a Phonebook Entry	35
Export/Import Phonebook Entries	35
Local Phonebook	35
LDAP Phonebook	35
Enterprise Phonebook	35
User Settings	37
Accessing the Settings	37
Available Settings	37
Settings Details	40
Basic Phone Settings	40
Basic Call Features	43
Information Display	44
Network Settings	44
Application Settings	48
Network Test	49
Reset	49
Restart	49
Entering Characters	50
Web User Interface Programming	52
Installation and Setup	53
Attaching/Removing the Stand	53
Connections	56
Wall Mounting	59
Hooking the Handset	62
Using a Headset	64
Setting Up the Unit	64
Maintaining the Unit	64
Resetting the Unit	64
Restarting the Unit	64
Cleaning the Unit	65
Open Source Software	66
Appendix	81
Specifications	81
Troubleshooting	82
Common Issues and Solutions	82
Error Messages	85
Index.....	86

Important Information

Data Security

We recommend observing the security precautions described in this section, in order to prevent the following:

- loss, disclosure, falsification, or theft of user information
- unauthorized use of the unit
- interference or suspension of use caused by an unauthorized party

We cannot be responsible for damages resulting from the misuse of this product.

User information is defined as the following:

- Phonebook names, phone numbers, and IP addresses
- Forwarding destination numbers
- Numbers stored in One-touch Dialing buttons
- Passwords used to log in to the Web user interface
- Call logs

Preventing Data Loss

- Keep a copy of all important data (such as the phonebook list) in case the machine malfunctions and data cannot be recovered.
- There is a risk that data stored or saved on the unit may be changed or deleted when, for instance, the unit is being repaired. To protect important data from unexpected damage, see Data Security (Page 7).

Preventing Data Disclosure

- Store backups in a secure location.
- Do not store sensitive personal information in the unit.
- Personal information (such as the phonebook list and call log) can be registered and/or saved on this unit. To prevent data leakage or unexpected damages, make a record of necessary user information, etc., and initialize the unit to return it to its factory settings in the following cases.
 - When passing on or disposing of the unit
 - When lending the unit
 - When having the unit repaired
- Make sure the unit is serviced by only a certified technician.

- When user information is sent from the unit to a PC or other external device, the confidentiality of that information becomes the responsibility of the customer. Before disposing of the PC or other external device, ensure that data cannot be retrieved from it by formatting the hard disk and/or rendering it physically unusable.

Preventing Data Disclosure Over the Network

- To ensure the security of private conversations, only connect the unit to a secure network.
- To prevent unauthorized access, only connect the unit to a network that is properly managed.
- Make sure all personal computers that are connected to the unit employ up-to-date security measures.

Security Information

- Security settings, such as passwords, cannot be undone at Panasonic service centers. Take measures to prevent passwords from being lost or forgotten.
- If a password is forgotten, initialize the unit and configure the settings again. For details, consult your administrator or dealer.
- For best security, set passwords that cannot be guessed easily, and change passwords periodically.
- If using SSL authentication, an NTP server must also be specified. Furthermore, if SSL authentication is performed without specifying an NTP server, authentication will be unconditionally validated without confirming the validity of the SSL certificate.

Additional Information

FCC and Other Information

This equipment has been tested and found to comply with the limits for a Class B digital device, pursuant to Part 15 of the FCC Rules. These limits are designed to provide reasonable protection against harmful interference in a residential installation. This equipment generates, uses, and can radiate radio frequency energy and, if not installed and used in accordance with the instructions, may cause harmful interference to radio communications. However, there is no guarantee that interference will not occur in a particular installation. If this equipment does cause harmful interference to radio or television reception, which can be determined by turning the equipment off and on, the user is encouraged to try to correct the interference by one or more of the following measures:

- Reorient or relocate the receiving antenna.
- Increase the separation between the equipment and receiver.
- Connect the equipment into an outlet on a circuit different from that to which the receiver is connected.
- Consult the dealer or an experienced radio/TV technician for help.

CAUTION

Any changes or modifications not expressly approved by the party responsible for compliance could void the user's authority to operate this device.

FCC Declaration of Conformity

Trade Name: Panasonic
Model Number: KX-UTG200
Responsible Party:
Panasonic Corporation of North America
Two Riverfront Plaza
Newark, NJ 07102-5490 U.S.A.
Telephone No.: 1-800-211-PANA (7262)

This equipment complies with Part 68 of the FCC rules and the requirements adopted by the ACTA. On the bottom of the cabinet of this equipment is a label that contains, among other information, a product identifier in the format
US:ACJ.....
If requested, this number must be provided to the telephone company.

If trouble is experienced with this equipment, for repair or warranty information, please contact:
Panasonic National Service Center
1615 Dundee Avenue Dock G
Elgin, IL 60120
1 (847) 888-7000

Connection to party line service is subject to state tariffs. Contact the state public utility commission, public service commission or corporation commission for information.

If your home has specially wired alarm equipment connected to the telephone line, ensure the installation of this equipment does not disable your alarm equipment. If you have questions about what will disable alarm equipment, consult your telephone company or a qualified installer.

WHEN PROGRAMMING EMERGENCY NUMBERS AND (OR) MAKING TEST CALLS TO EMERGENCY NUMBERS:

- a. Remain on the line and briefly explain to the dispatcher the reason for the call.
- b. Perform such activities in the off-peak hours, such as early morning or late evenings.

This equipment is hearing aid compatible.

When you hold the phone to your ear, noise might be heard in your Hearing Aid. Some Hearing Aids are not adequately shielded from external RF (radio frequency) energy. If noise occurs, use the speakerphone option (if applicable) when using this phone. Consult with your audiologist or Hearing Aid manufacturer about the availability of Hearing Aids which provide adequate shielding to RF energy commonly emitted by digital devices.

Compliance with TIA-1083 standard



Telephone handsets identified with this logo have reduced noise and interference when used with T-Coil equipped hearing aids and cochlear implants.

Before Operating the Telephone

Accessory Information

Included Accessories^{*1}

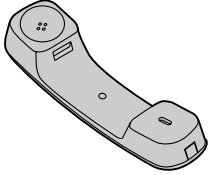
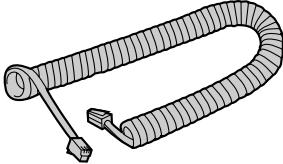
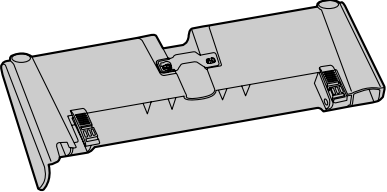
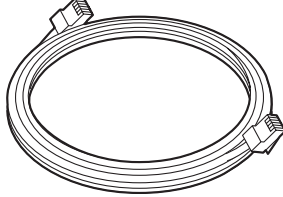
Handset (1)  [Part No.] 95.1204T00	Handset Cord (1)  [Part No.] 371.00447.005
Stand (1)  [Part No.] 467.00209.005	Ethernet cable (1)  [Part No.] 371.00473.005

^{*1} For extra orders for the accessories, call toll-free: 1-800-332-5368.

Note

- The illustrations may differ from the appearance of the actual product.

Optional Accessories

AC Adaptor	<ul style="list-style-type: none"> • DSA-42D-48 2 480063 (P/N: 381.00398.005)
Wall Mount Kit	<ul style="list-style-type: none"> • KX-A433

Location of Controls

Front View

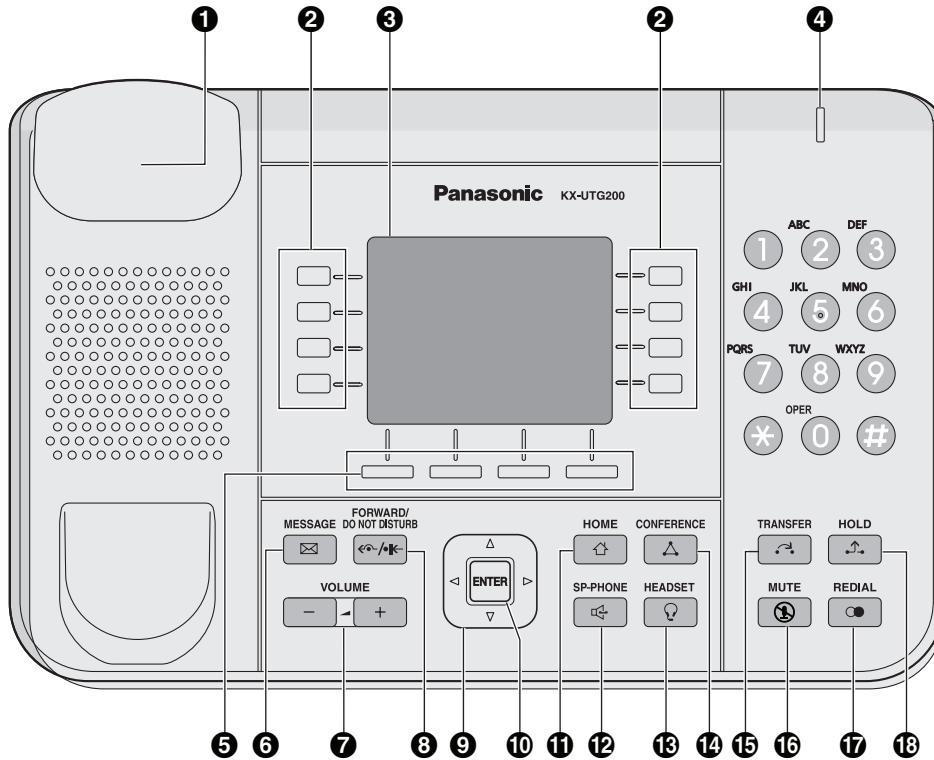

- 1 Handset Hook**
Keeps the handset stable when the unit is mounted on a wall.
- 2 Flexible Buttons/Flexible Button Lamps**
Used to make or receive calls, or perform the feature that has been assigned to the button. The flexible button lamp shows the status of each flexible button.
- 3 LCD (Liquid Crystal Display)**
The unit is equipped with a 3.5-inch color LCD and LCD backlight.
- 4 Message/Ringer Lamp**
When you receive a call, the lamp flashes red.
When someone has left you a message, the lamp stays on red.
- 5 Soft Buttons (S1 to S4)**
S1 to S4 (located below the display) are used to select the item displayed on the bottom line of the display.
- 6 MESSAGE**
Used to access your voice mailbox.
- 7 VOLUME**
Used to adjust the volume.
- 8 FORWARD/DO NOT DISTURB**
Used to set Call Forwarding or Do Not Disturb on your extension.
- 9 Navigator Key**
Used to select desired items.

- ⑩ **ENTER**
Used to assign the selected item.
- ⑪ **HOME**
Used to return the display to the home screen.
- ⑫ **SP-PHONE (Speakerphone)**
Used for performing hands-free operations. When the SP-PHONE is used, its lamp turns red.
- ⑬ **HEADSET**
Used when using a headset. When the HEADSET is used, its lamp turns red.
- ⑭ **CONFERENCE**
Used to establish a three-way conference.
- ⑮ **TRANSFER**
Used to transfer a call to another party.
- ⑯ **MUTE**
Used to mute the microphone/handset/headset during a conversation. When the MUTE is used, its lamp turns red.
- ⑰ **REDIAL**
Used to redial the last dialed number.
- ⑱ **HOLD**
Used to put a call on hold.

Left Side View

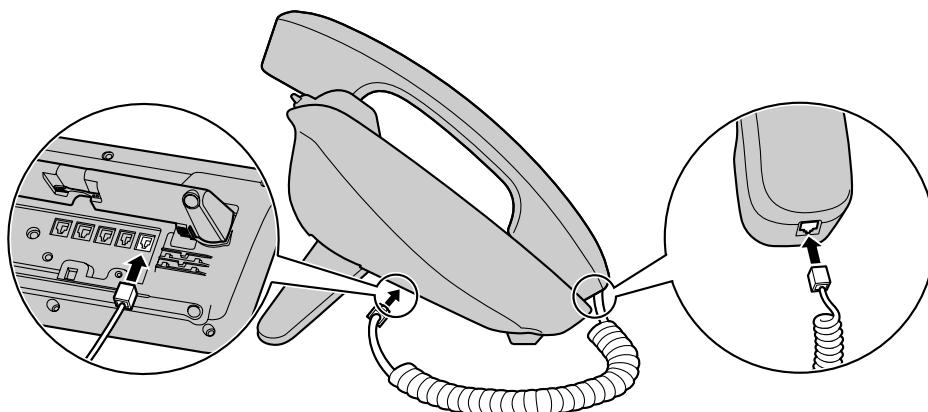

Bottom View

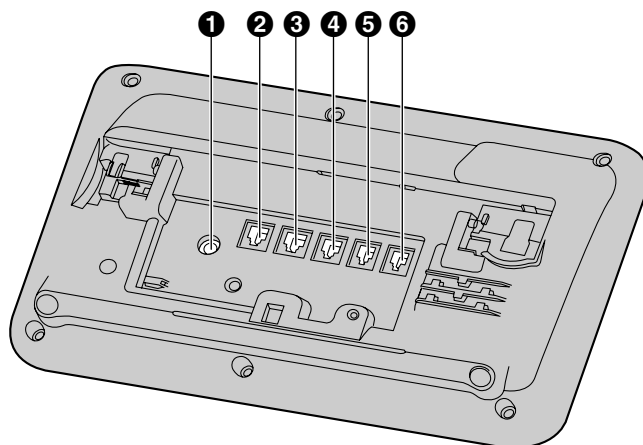

- ❶ DC Jack
- ❷ LAN Port
- ❸ PC Port
- ❹ EHS Jack
- ❺ Headset Jack
- ❻ Handset Jack

Screens

This section explains the screens, and the buttons and icons that appear on the display.

Home Screen

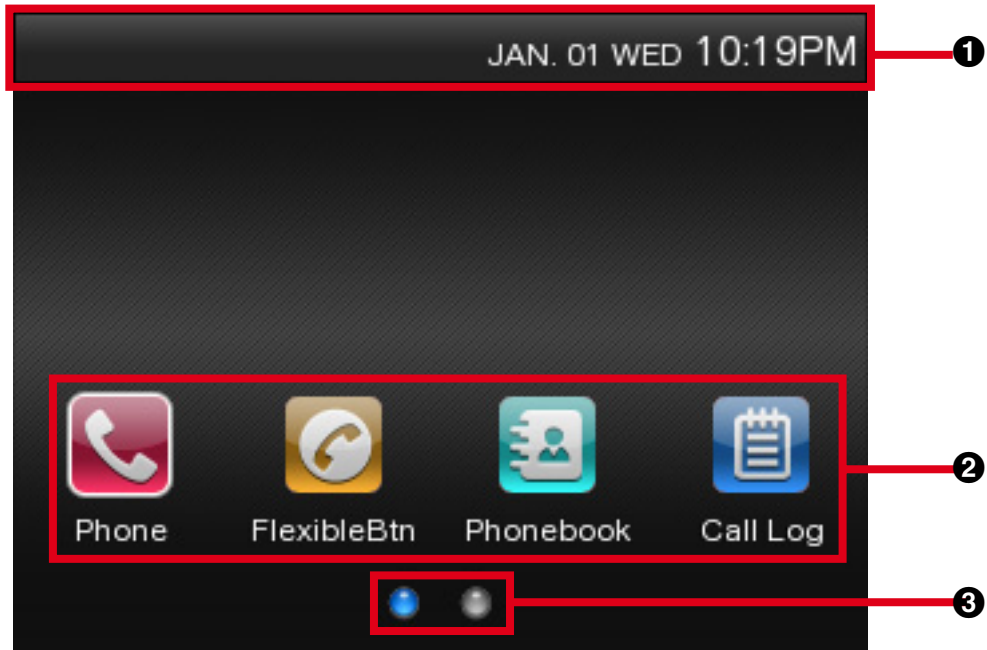









1 Status Bar

Indicates the status of various features (Page 15) as well as information such as the date and time.

2 Home Screen Icons

The Home screen icons can be used to access various functions and screens on the phone. Select Home screen icons by pressing [◀] or [▶] and then pressing [ENTER]. You can also select icons by pressing the corresponding soft buttons.

Icon	Description
	Access the Phone screen. (Page 19)
	Access the Flexible button screen. (Page 29)
	Access the phonebook. (Page 34)
	Access the call log. (Page 20)
	Access the user setting menus. (Page 37)
	Access the paging screen. (Page 21)
	Access the service screen. (Page 28)
	Access Instant Messaging and Presence. (Page 31)

3 Page Buttons

Indicates how many pages are available for the Home screen and which page is currently displayed. If other pages are available, press [▲] or [▼] to display the other page.

Phone Screen

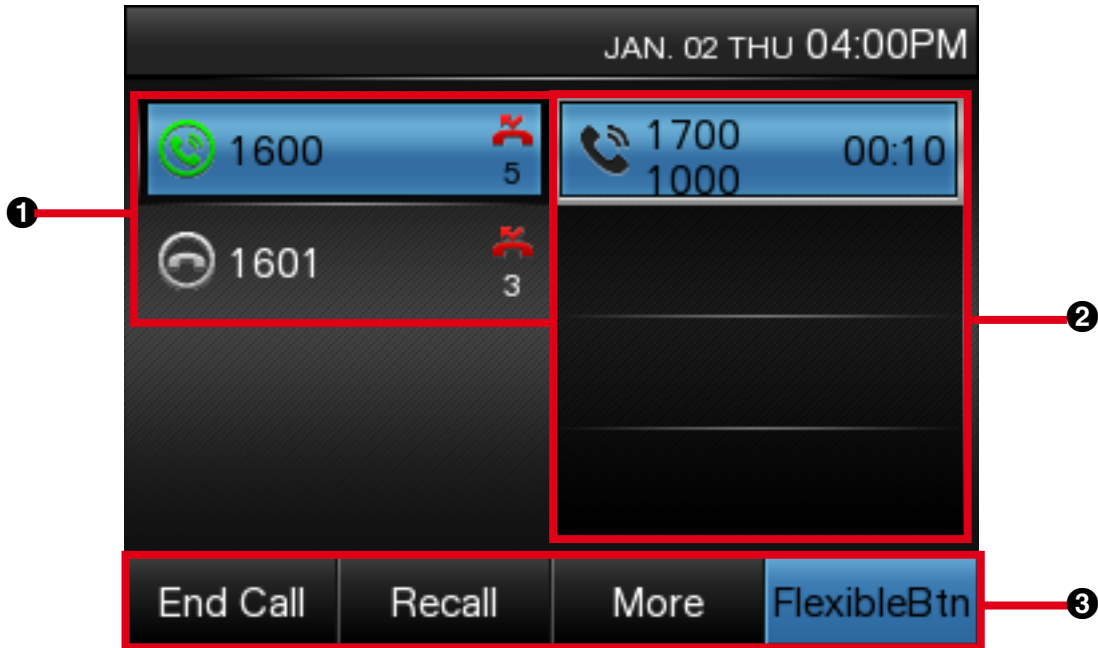

1 Line Buttons

Line buttons are used to access the lines registered to the unit. Line buttons can be selected by pressing the corresponding flexible buttons or by pressing [▲] or [▼]. A maximum of 4 lines can be registered to the unit. The status of line buttons can be confirmed with the lamp indications of the flexible buttons or the displayed line icons (Page 15).

Flexible button lamp indication

- **Off:** Idle
- **Green on:** You are on a call.
- **Flashing green:** A call is being received.
- **Red on:** A call is on hold.

2 Call Buttons

Call buttons are used to select calls to or from the unit. Call buttons can be selected by pressing the corresponding flexible buttons or by pressing [▲] or [▼]. The status of call buttons can be confirmed with the lamp indications of the flexible buttons or the displayed call icons (Page 16).

Flexible button lamp indication

- **Off:** Idle
- **Green on:** You are on a call.
- **Flashing green:** A call is being received.
- **Flashing orange:** A call is on hold.
- **Red on:** A shared line¹ is in use or on hold (private) at another unit.

- **Flashing red:** A shared line^{**1} is on hold (normal) at another unit.
- ^{**1} Shared line is an optional feature and may not be supported on your phone system. See Page 28 for information.





③ Soft Button Icons

Soft buttons icons are displayed for functions that can be used depending on the screen displayed and the state of the unit. If **More** is displayed, you can press it to display other available soft button icons. See Page 17 for a list of commonly used soft button icons.

Icons



















Status Icons





Status icons indicate the status of the unit and are displayed at the top of the screen in the status bar.

Icon	Description
	Displayed when the ringer is turned off (Page 19).
	Displayed when [HEADSET] is pressed.
	Displayed when the connection to the LAN is lost. If this icon is displayed, check the Ethernet cable connection.
	Displayed when ECO mode is enabled.
	Displayed when a firmware upgrade is available.

Line Icons

Line icons indicate the status of lines in the Phone screen.







General Line Icon	Shared Line Icon ^{**1}	Description
		Displayed when registering to the SIP server.
		Displayed when registration to the SIP server has been lost. If this icon is displayed, consult your administrator or dealer.
		Indicates the line is registered to the SIP server.
		Displayed when the line is on a call.
		Displayed when the line has an incoming call.
		Displayed when the line has a call on hold.
		Indicates that DND (Do not Disturb) settings are active for the line.
		
		Indicates that call forwarding settings are active for the line.

General Line Icon	Shared Line Icon ^{*1}	Description
		Indicates that auto answer settings are active for the line.
	—	Displayed next to lines that have new messages (Page 26).
	—	Indicates that there was a missed call. This icon also indicates a missed call in the call log.

^{*1} Shared line is an optional feature and may not be supported on your phone system. See Page 28 for information.

Call Icons



Call icons indicate the status of calls and lines in the Phone screen.

Icon	Description
	Displayed when dialing on-hook.
	Displayed when dialing off-hook, or when on an active incoming or outgoing call.
	Displayed when there is an incoming call.
	Displayed when a call is on hold.
	Displayed when an incoming call is on hold.
	Displayed when another phone on a shared line ^{*1} is on call.
	Displayed when another phone on a shared line ^{*1} is on hold.

^{*1} Shared line is an optional feature and may not be supported on your phone system. See Page 28 for information.

Call Log Icons

Call log icons indicate the type of call displayed in the call log.

Icon	Description
	Indicates a missed call.
	Indicates a placed call.
	Indicates a received call.

Soft Buttons and Soft Button Icons

By pressing a soft button (**S1** to **S4**), you can access the function displayed directly above it.

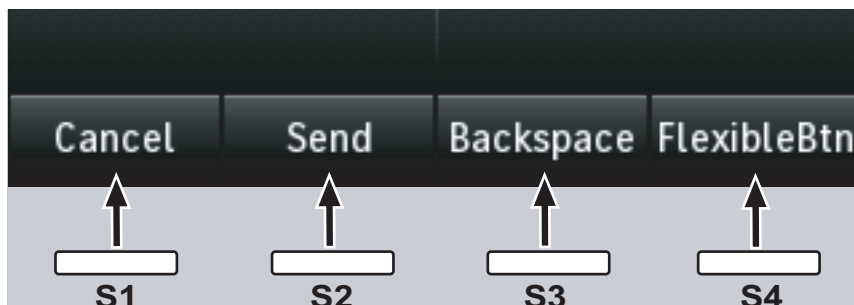

In this manual, soft buttons are referred to by their corresponding icons.

In the example here, "Press **Cancel**", "Press **Send**", "Press **Backspace**", or "Press **FlexibleBtn**" would indicate pressing **S1**, **S2**, **S3**, or **S4** respectively.

The following is a list of commonly used soft buttons.

Icon	Description
Back	Return to the previous screen.
Call Log	Access the call log (Page 20).
Phonebook	Access the phonebook (Page 34).
Cancel	Cancel the operation.
Backspace	Erase the number or character to the left of the cursor (Page 20).
Search	Search for a phonebook entry (Page 20).
End Call	End a call.
Enter	Save or confirm the information shown on the display, or enter into the next screen. Note <ul style="list-style-type: none"> You can also use the physical [ENTER] button to perform the same operation as this soft button.
More	Display other available soft buttons.
Answer	Answer an incoming call (Page 19).
Reject	Reject an incoming call (Page 22).
Blind	Perform a blind transfer (Page 25).
Save	Save the information shown on the display (Page 22, Page 34).
Send	Make a call (Page 20).
Edit	Edit the information shown on the display (Page 22, Page 34).
Prefer	Assign the preferred number to dial among multiple registered phone numbers in the same phonebook entry when making a call using the phonebook (Page 34).
FlexibleBtn	Access the Flexible button screen.

Before Operating the Telephone

Icon	Description
Resume	Resume a call that has been put on hold.
New Call	Initiate a new call.

Basic Operations

This section explains the basics of using the unit.

Confirming Your Extension Number

In stand-by mode (i.e., when you do not have any active calls on the Phone screen), you can view the extension number and name registered to the unit.

Going off- and on-hook

There are several ways to go off-hook and on-hook:

- Using the handset
- Using the **[SP-PHONE/HEADSET]** button
- Using the soft buttons

Going off-hook

In this manual, when you see the phrase "go off-hook", it means to do any of the following:

- Lift the handset off of its cradle.
- Press **[SP-PHONE/HEADSET]** while the handset is on its cradle. This enables hands-free mode.
- Press **[SP-PHONE/HEADSET]** when using a headset.

Note

- Certain soft buttons, such as **Answer**, function like the **[SP-PHONE]** button.

Going on-hook

In this manual, when you see the phrase "go on-hook", it means to do any of the following:

- Replace the handset on its cradle.
- Press **[SP-PHONE/HEADSET]** when using a headset or when you are in hands-free mode.

Hands-free Mode

In hands-free mode, you can talk and hear the other party in a conversation without using the handset. This mode is useful for performing other tasks during a conversation, such as writing.

Enabling hands-free mode

You can enable hands-free mode in one of the following ways:

- In stand-by mode, press **[SP-PHONE]**.
- During a conversation while using the handset, press **[SP-PHONE]**. You can then return the handset to its cradle.
- When receiving an incoming call, press **Answer**.

Canceling hands-free mode

You can cancel hands-free operation simply by lifting the handset off its cradle.

Adjusting the Volume

You can adjust the ringer, handset, headset, and speaker volume using **[-]** and **[+]** on the VOLUME key.

Adjusting the ringer volume

When receiving a call or when the handset or headset are not in use, press **[-]** or **[+]**.

Note

- When the ringer volume is turned all the way down, "🔇" is displayed.

Adjusting the handset/headset/speaker volume

Press **[-]** or **[+]** during a conversation when using the handset, headset, or when you are in hands-free mode.

Feature Operations

Making Calls

This section explains the basic methods for making a call.

Making a Call

1. In stand-by mode, go off-hook.
2. Enter the number you want to call.
3. Press **Send**, or wait a few seconds for the number to be dialed.
4. To end the call, go on-hook.

Note

- If more than one line is available at your unit, you can press an idle line button (flexible button) assigned to the line you want to use before entering the number. For details about line buttons, see "Flexible Buttons (Page 29)". You can also select a line by pressing **[▲]** or **[▼]**.
- To delete a number you entered, press **Backspace**.

Making a Call from the Phonebook List

Scrolling through all entries

1. On the Home screen, select .
2. Press **[▲]** or **[▼]** to select an entry.
3. Go off-hook.
4. To end the call, go on-hook.

Note

- In step 2, if multiple phone numbers are stored for the entry, you can press **Details** and then select the phone number to call.

Searching by name

1. On the Home screen, select .
2. Press **Search**.
3. Enter the name (max. 20 characters) you want to search for.
 - The entries that match your search are displayed.
4. Press **[▲]** or **[▼]** to select the desired entry.

5. Go off-hook.
6. To end the call, go on-hook.

Note

- For details about entering characters, see "Entering Characters (Page 50)".
- In step 4, if multiple phone numbers are stored for the entry, you can press **Details** and then select the phone number to call.

Dialing by Using Call Logs

The last 300 missed, received, and placed calls are stored in their respective logs, in order of newest to oldest call.

Missed, received, and placed calls appear in the All Calls call log in addition to their respective call logs. You can make calls to the numbers listed in the call logs.

1. On the Home screen, select .
2. Press **[▲]** or **[▼]** to select the call log type, and then press **[ENTER]**.
3. Press **[▲]** or **[▼]** to select the desired entry.
4. Go off-hook.
5. To end the call, go on-hook.

Note

- You can add a call log entry to the phonebook. See "Adding a Phonebook Entry from the Call Log (Page 34)".
- See Page 16 for information on call log icons.

Editing a phone number before dialing from the call log

You can edit a phone number in the call log before using it to dial.

1. On the Home screen, select .
2. Press **[▲]** or **[▼]** to select the log type, and then press **[ENTER]**.
3. Press **[▲]** or **[▼]** to select the desired entry.
4. Press **Edit Dial**.
5. Edit the number, and then go off-hook.
6. To end the call, go on-hook.

Redialing the Last Number You Dialed (Redial, Last Number)

You can redial the last phone number that you dialed.

1. Go off-hook.

2. Press **[REDIAL]**.
3. To end the call, go on-hook.

Note

- To select a line to use to redial, press the appropriate line button (flexible button) before you press **[REDIAL]**. For details about line buttons, see "Flexible Buttons (Page 29)". You can also select a line by pressing **[▲]** or **[▼]**.

One-touch Dialing

You can make a call with a One-touch operation if a One-touch Dialing button has been created for the desired party. One-touch Dialing buttons can also be configured to access features of your phone system, if available.

1. On the Home screen, select .
2. Press the One-touch Dialing button (flexible button).
3. To end the call, go on-hook.

Note

- A BLF (Busy Lamp Field) button (flexible button) can also be used to call an extension simply by pressing the button. For details, consult your administrator or dealer.
- For details about flexible buttons such as One-touch Dialing buttons and BLF buttons, see "Flexible Buttons (Page 29)".

Intercom

If the SIP server supports the Intercom feature, you can use it to make intercom announcements to other phones. For details, consult your administrator or dealer.

Multicast Paging (Push To Talk)

Multicast paging enables you to send a one-way announcement to a preconfigured page group. To use multicast paging, the Enable Multicast Paging setting must be enabled through Web user interface programming (Page 52). For details, consult your administrator or dealer.

Sending multicast paging announcements

1. On the Home screen, select .

2. Press **[▲]** or **[▼]** to select the page group, and then press **Start**.
3. Make the announcement.
4. To end the announcement, press **Stop**.

Receiving multicast paging announcements





When a multicast paging announcement is received, it is automatically played. By default, announcements are played through the speaker.

Note

- To pause received announcements, go on-hook, or press **[SP-PHONE]** or **Pause**. To start playing messages again, press **Play**.
- If Paging DND is enabled, all incoming pages are rejected except for priority 1 pages.

Multicast Paging Icons

Multicast paging icons indicate the status of pages and the multicast paging groups registered to the unit.

Icon	Description
	Indicates an outgoing page.
	Indicates an incoming page.
	Indicates the paging group is idle.
	Indicates the incoming page is paused.
	Indicates the incoming page is being played after being paused.

Receiving Calls

This section explains the basic methods for receiving a call.

Receiving a Call

1. Go off-hook.
2. To end the call, go on-hook.

Auto answer

You can have the unit automatically answer a received call. The call is connected after a programmed number of rings.

- To enable Auto Answer:
On the Phone screen, press **AutoAns**.
"Auto-answer is turned on" is displayed.
- To disable Auto Answer:
On the Phone screen, press **AutoAns**.
"Auto-answer is turned off" is displayed.

Note

- When Auto Answer is enabled,  appears on the line button it was enabled for.

Rejecting Calls

You can reject a received call at your unit or set the unit to reject certain calls.

Rejecting receiving calls

1. When receiving a call, press **Reject**.

Rejecting anonymous calls

You can set the unit to reject calls when the unit receives a call without a phone number. To reject anonymous calls, the Block Anonymous Call setting must be enabled through Web user interface programming (Page 52). For details, consult your administrator or dealer.

If the Block Anonymous Call setting is enabled through Web user interface programming, you must configure the unit to block anonymous calls.

1. On the Home screen, select .
2. Press **[▲]** or **[▼]** to select "Basic Call Features", and then press **[ENTER]**.
3. Press **[▲]** or **[▼]** to select "Block Anonymous Call".

4. Press **On**.

Note

- Rejected phone numbers will not be stored in the incoming or missed call log.
- Depending on the line a call is arriving on, the call may not be rejected.

Rejecting specific calls

You can set the unit to reject specific phone numbers.

Note

- Rejected phone numbers will not be stored in the incoming or missed call log.

Adding a phone number

You can store a maximum of 30 phone numbers you want to reject in the rejection list of the unit.

1. On the Home screen, select .
2. Press **[▲]** or **[▼]** to select "Basic Phone Settings", and then press **[ENTER]**.
3. Press **[▲]** or **[▼]** to select "Call Block", and then press **[ENTER]**.
4. Press **Add**.
5. Enter the telephone number (max. 32 digits), and then press **Save**.

Note

- To register additional telephone numbers, repeat the procedure from step 4.

Adding a phone number from the call log

You can add a phone number by referring to the call log.

1. On the Home screen, select .
2. Press **[▲]** or **[▼]** to select the log type, and then press **[ENTER]**.
3. Press **[▲]** or **[▼]** to select the entry with the phone number you want to reject.
4. Press **Save**.
5. Press **[▲]** or **[▼]** to select "Call Block", and then press **[ENTER]**.
6. Press **Yes**.

Note

- You cannot perform this operation in "Placed Calls" or on placed calls in "All Calls".

Editing a stored phone number

1. On the Home screen, select .
2. Press **[▲]** or **[▼]** to select "Basic Phone Settings", and then press **[ENTER]**.

3. Press [▲] or [▼] to select "Call Block", and then press [ENTER].
4. Press [▲] or [▼] to select the phone number you want to edit, and then press **Edit**.
5. Edit the phone number as necessary, and then press **Save**.

Deleting a stored phone number

1. On the Home screen, select .
2. Press [▲] or [▼] to select "Basic Phone Settings", and then press [ENTER].
3. Press [▲] or [▼] to select "Call Block", and then press [ENTER].
4. Press [▲] or [▼] to select the phone number you want to delete, and then press **Delete**.
5. Press **Yes**.

Ignoring Calls

You can ignore incoming calls at your unit. The ringer is muted when a call is ignored.

1. When receiving a call, press **Ignore**.
 - To answer an ignored call, press **Answer**.
 - To reject an ignored call, press **Reject**.
 - To close the incoming call dialog, press **Close**.

Holding a Call

You can put a call on hold by holding the call at your extension.

To hold the current call

1. Press [HOLD], and then go on-hook.

To retrieve a call on hold at your extension

1. Press [HOLD], and then go off-hook.

Note

- If a call is not retrieved within a specified time, you will hear an alarm as a reminder.
- If Automatic Call Hold is enabled on your unit, the call will also be put on hold if you press a flexible button other than the one for the current call. For details, consult your administrator or dealer.

Receiving a Second Call (Answering Call Waiting)

During a conversation, if a second call arrives, you will hear a call waiting tone.

You can answer the second call by disconnecting or holding the current call.

To disconnect the current call and then talk to the new party

1. Go on-hook while hearing the call waiting tone.
2. Go off-hook.

To hold the current call and then talk to the new party

1. Press [▲] or [▼] to select the call button for the current call, and then press [HOLD].
2. Press the green flashing call button (flexible button) for the new call or press **Answer**.

Note

- If Automatic Call Hold is enabled on your unit, the call will also be put on hold if you press a flexible button other than the one for the current call. For details, consult your administrator or dealer.
- For details about call buttons, see Page 14.

Talking to Two Parties Alternately (Call Splitting)

When you are talking to one party and have another party on hold, you can switch the call on hold and the current call.

1. Press [HOLD] during a conversation.
2. Press **New Call** and call the second party.
3. Press [HOLD], and then press the orange flashing call button (flexible button) that corresponds to the other party on hold or press **Resume**.

Note

- For details about call buttons, see "Flexible Buttons (Page 29)".
- If a call is not retrieved within a specified time, you will hear an alarm as a reminder.

Transferring a Call (Call Transfer)

You can transfer a call to another destination (extension or outside party).

To transfer

1. Press **[TRANSFER]** during a conversation.
2. Call the party you want to transfer the call to.
3. Wait until the other party answers to announce the transfer.
4. Press **[TRANSFER]**.

Note

- If unscreened transfers are supported on your phone system, step **3** can be omitted. For details, consult your administrator or dealer.

To do a blind transfer

1. Press **Blind** during a conversation.
2. Call the party you want to transfer the call to.
3. Go on-hook.

To Transfer with a Flexible Button

1. Press **FlexibleBtn** during a conversation.
2. Press the desired flexible button.
3. Press **[▲]** or **[▼]** to select "Transfer", and then press **[ENTER]**.
4. Wait until the other party answers to announce the transfer.
5. Go on-hook.

Note

- If unscreened transfers are supported on your phone system, step **4** can be omitted. For details, consult your administrator or dealer.
- For details about flexible buttons, see "Flexible Buttons (Page 29)".

Mute

You can mute your voice during a conversation. While the mute feature is turned on, you will be able to hear the other party, but the other party will not be able to hear you.

The built-in microphone, handset, and headset are all muted when the mute feature is turned on.

To mute/unmute

1. Press **[MUTE]**.

Conference Call

During a conversation, you can add an additional party to your call and establish a conference call.

Notice

- Your phone system may support advanced conference features, such as conference calls with four or more parties. In this case, the procedures for handling a conference call may be different from those explained in this section. For details about your phone system, consult your administrator or dealer.

Making a Conference Call

1. Press **[CONFERENCE]** to put the current call on hold.
2. Call the party you want to add to the conversation.
3. After the called party answers, press **[CONFERENCE]** to begin the conference call.

Removing a Party from the Conference

During a conference, you can remove other parties from the conference. However, this operation is available only during conference calls you initiate.

1. Press the call button (flexible button) that corresponds to the party you want to disconnect.
2. Press **End Call**.
 - The party is disconnected.
 - You can continue the conversation with the remaining party.

Note

- For details about call buttons, see "Flexible Buttons (Page 29)".

Ending a Conference Call

1. Go on-hook during a conference.

Checking Messages

Checking New Messages

When you receive a voice message,  is displayed on the line button that received the call, and the Message/Ringer lamp turns red.

You can check your new messages by accessing your mailbox.

1. Press **[MESSAGE]**.
2. If the unit has multiple lines, press **[▲]** or **[▼]** to select the line button on which  is displayed, and then go off-hook.

Checking Missed Calls

When there are new missed calls,  appears in the Phone screen.

1. On the Home screen, select .
2. Press **[▲]** or **[▼]** to select "Missed Calls", and then press **[ENTER]**.
3. Press **[▲]** or **[▼]** to select the missed call.

Note

- In the "All Calls" and "Missed Calls" logs,  is displayed for missed calls.
- For details about making calls from the call log, see "Dialing by Using Call Logs (Page 20)".



Erasing All Call Logs in a Log Category

1. On the Home screen, select .
2. Press **[▲]** or **[▼]** to select the log category, and then press **[ENTER]**.
3. Press **Clear List**, and then press **Yes**.
 - All call logs for the selected category will be erased.

Call Forwarding/Do Not Disturb

You can have received calls automatically forwarded to another destination. You can also have received calls rejected (Do Not Disturb).

Note







- When Call Forwarding is enabled,  appears on the line button it is enabled for.
- When Do Not Disturb is enabled,  appears on the line button it is enabled for.

To access the FWD/DND settings

1. On the Home screen, select .
2. Press **[▲]** or **[▼]** to select the desired line button, and then press **[FORWARD/DO NOT DISTURB]**.
3. Press **[▲]** or **[▼]** to select the type of FWD or DND setting to apply.
4. Configure the settings as necessary (Page 43).

Optional Group Features

The unit supports the optional ACD (Automatic Call Distribution), Call Pickup, Direct Call Pickup, Call Park, and Call Retrieve optional group features. If the SIP server supports these features, the following icons will be displayed in the Phone screen depending on the status of the groups. Consult your administrator or dealer for more information.

Icon	Description
	Indicates there is a parked call.
	Indicates that the line is signing in to an ACD group.
	Indicates that the line is signing out of an ACD group.
	Indicates that ACD is available for the line.
	Indicates that ACD is not available for the line.
	Indicates that ACD for the line is in wrap up mode.

SCA (Shared Call Appearance)

SCA (Shared Call appearance) or shared line is a feature that allows multiple units to use a shared line. This is an optional feature and may not be supported on your phone system. For more information consult your administrator or dealer.

Note

- See Page 15 for information on the statuses of shared lines.

Services

The Services function enables you to access interactive services, such as stock and weather information, and phone related services, such as Enterprise phonebook. The Application Settings (Page 39) must be configured in order to use Services. For information about the required settings and available services, consult your administrator or dealer.

Flexible Buttons

The flexible buttons on the unit can be customized to be used to make or receive calls or as feature buttons. These buttons are configured by your administrator or dealer.

Access the Flexible button screen by selecting  on the Home screen or by pressing **FlexibleBtn** on the Phone screen.

Flexible Button Screen

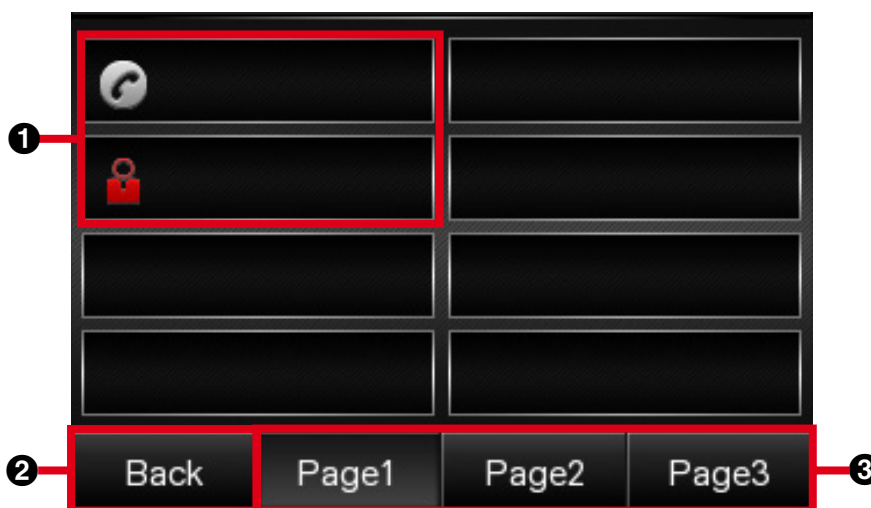

❶	Shows the available flexible buttons. Press the corresponding physical flexible buttons to select the available flexible buttons.
❷	Press to return to the previous screen.
❸	Press to display other flexible button pages.

The following types of flexible buttons are available:

One-Touch

Calls the party or accesses a feature assigned to the button. See "One-touch Dialing (Page 21)".

BLF (Busy Lamp Field)

Calls the extension assigned to the button. During a conversation, a BLF button can be used to transfer calls to the assigned extension ("To Transfer with a Flexible Button (Page 25)").

A BLF button's lamp also shows the current status of the assigned extension.

Lamp Indication

- **Off:** The assigned extension is idle.
- **Red on:** The assigned extension is using the line.
- **Flashing green rapidly:** The assigned extension is receiving a call.
If enabled through Web user interface programming, pressing the button answers the call (Directed Call Pickup).







Note

- BLF (Busy Lamp Field) is an optional feature and may not be supported on your phone system.

Flexible Button Icons

Flexible button icons indicate the type and status of the flexible buttons in use.

Feature Operations

Icon	Description
	Indicates a one-touch flexible button.
	Indicates a BLF flexible button is subscribing.
	Indicates a BLF flexible button is idle.
	Indicates a BLF flexible button is busy.
	Indicates a BLF flexible button is alert.
	Indicates a call with BLF flexible button is parked.

IM&P (Instant Messaging & Presence)

IM&P (Instant Messaging & Presence) is a service that enables you to send short messages and call other users registered to the service. In order to use IM&P, you must have a user account. For more information, consult your administrator or dealer.

Logging in to IM&P

When you first use IM&P you must log in by entering the server address, user name, and password.

IM&P Login Screen

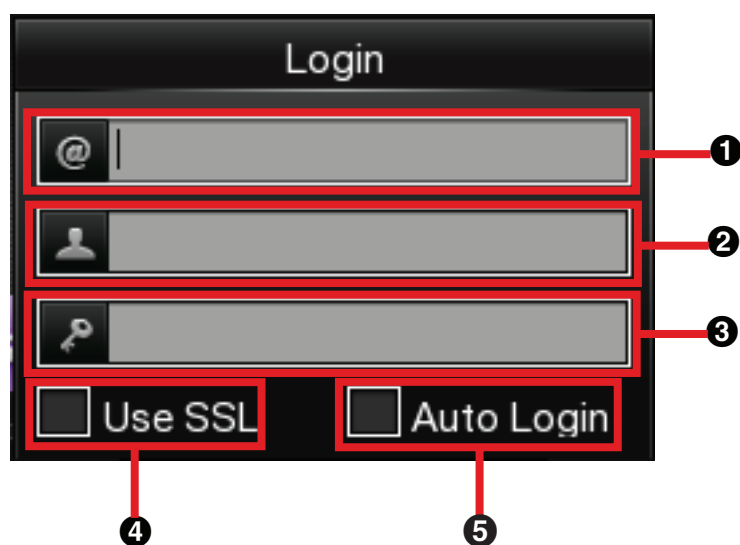

❶	Enter the server address.
❷	Enter the user name.
❸	Enter the password.
❹	Select when secure connections are required.
❺	Select to log in to IM&P automatically.

Logging in for the first time

1. On the Home screen, select .
2. Press **[▲]** or **[▼]** to select the desired field and enter the server address, user name, and password.
 - If a secure connection is required, select "Use SSL".
3. Press **Login**.
 - The IM&P screen is displayed.

Logging in subsequent times

1. On the Home screen, select .
 - The login screen is displayed with the configured server address, user name, and password already entered.
 - If you want to log in with a different account, change the settings as required.
2. Press **Login**.

- The IM&P screen is displayed.

Logging out

1. On the IM&P screen, press **Logout**.

Presence

Presence is used to show the status of users. You can check if other users are available by checking the presence displayed next to their names. Other users can also check if you are available by checking your presence. The following types of presences can be used.

Presence	Description
Available	Indicates that the user is online and is able to communicate.
Busy	Indicates that the user is online but is not able to communicate.
Away	Indicates that the user has been idle or is away.
Offline	Indicates that the user is offline.

Setting your Presence

1. On the IM&P screen, press **[▲]** or **[▼]** to select "My Status".
2. Press **[▲]** or **[▼]** to select "Presence State".
3. Press **[▲]** or **[▼]** to select the desired presence, and then press **Select**.

Contacts

Contacts are IM&P users registered to your IM&P account who you can send messages to or call. Addition, editing, or deletion of contacts cannot be performed on the unit and must be performed on the SIP server. For more information, consult your administrator or dealer.

Contact Type	Description
All Contacts	Contains a list of all the contacts registered to the unit.
Groups	Contains a list of contacts organized into separate groups. You can only send a message or call individual contacts within a group. You cannot send messages or call all contacts in a group simultaneously.
Non-IM&P contacts	Contains a list of contacts not related to IM&P.
Conferences	Contains a list of special groups configured for conference calls. By selecting a conference group, you can have a conference call with members of the conference group.
Favorites	Contains a list of favorite contacts.

Contact Type List Screen

The following screen is an "All Contacts" screen.

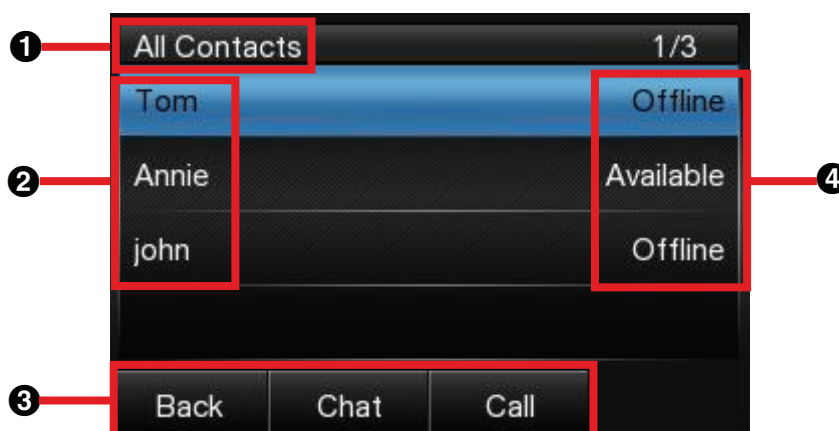

①	Contact type
②	Contacts
③	Available actions
④	Status of contacts

Sending Messages to Contacts

You can send instant messages to your contacts. Messages can be a maximum of 128 characters in length.

Sending Messages

- On the IM&P screen, press **[▲]** or **[▼]** to select the contact type.
 - If "Groups" is selected, select the group after selecting the contact type.
- Press **[▲]** or **[▼]** to select the contact, and then press **Chat**.
- Enter the message (max. 128 characters), and then press **Send**.

Calling Contacts

You can use IM&P to make calls with your contacts.

Calling Contacts

- On the IM&P screen, press **[▲]** or **[▼]** to select the contact type.
 - If "Groups" is selected, select the group after selecting the contact type.
- Press **[▲]** or **[▼]** to select the contact, and then press **Call**.

Making Conference Calls

You can use IM&P to make conference calls.

Making Conference Calls

- On the IM&P screen, press **[▲]** or **[▼]** to select "Conferences".
- Press **[▲]** or **[▼]** to select the conference group, and then press **Call**.

Customizing the Telephone

Phonebook List

Adding a New Phonebook Entry

You can add a maximum of 1,000 phonebook entries to the unit.

To make a call from the phonebook, see "Making a Call from the Phonebook List (Page 20)".

1. On the Home screen, select .
2. Press **Add**.
3. Enter a name (max. 24 characters).
4. Press **[▲]** or **[▼]** to select the phone number type (**1** to **5**) or "Ringtone".
5. Do one of the following, depending on your selection in the previous step:
 - If you selected a phone number type**
 - Enter the phone number (max. 32 digits).
 - If you selected "Ringtone"**
 - Press **[ENTER]**, press **[▲]** or **[▼]** to select the desired ringtone, and then press **Set**.
6. To add another phone number to the entry, repeat the procedure from step 4.
7. Press **Save**.

Note

- If you store multiple phone numbers in the entry, you can assign the preferred number to use when you call this party. In step 4, select the desired number, and then press **Prefer**.

Adding a Phonebook Entry from the Call Log

You can add new phonebook entries from the call log.

1. On the Home screen, select .
2. Press **[▲]** or **[▼]** to select the call log type, and then press **[ENTER]**.
3. Press **[▲]** or **[▼]** to select the desired call log entry, and then press **Save**.
4. Do one of the following, depending on your selection in the previous step:
 - If you selected a placed call**
 - Go to step 5.
 - If you did not select a placed call**

- Press **[▲]** or **[▼]** to select "Phonebook", and then press **[ENTER]**.
- 5. Enter a name (max. 24 characters).
- 6. Press **[▲]** or **[▼]** to select the phone number type (**1** to **5**) or "Ringtone".
- 7. Do one of the following, depending on your selection in the previous step:
 - If you selected a phone number type**
 - Enter the phone number (max. 32 digits).
 - If you selected "Ringtone"**
 - Press **[ENTER]**, press **[▲]** or **[▼]** to select the desired ringtone, and then press **Set**.
- 8. To add another phone number to the entry, repeat the procedure from step 6.
- 9. Press **Save**.

Note

- If a name is stored in the call log, it is automatically entered in step 5.
- If you store multiple phone numbers in the entry, you can assign the preferred number to use when you call this party. In step 6, select the desired number, and then press **Prefer**.

Editing a Phonebook Entry

You can edit the information stored in phonebook entries.

1. On the Home screen, select .
2. Press **[▲]** or **[▼]** to display the desired entry, or press **Search** and search for the desired entry (Page 35).
3. Press **Edit**.
4. Press **[▲]** or **[▼]** to select the item you want to edit.
5. Edit the item as necessary.
6. Press **Save**.

Note

- If you store multiple phone numbers in the entry, you can assign the preferred number to use when you call this party. In step 4, select the desired number, and then press **Prefer**.

Searching for a Phonebook Entry

You can search the phonebook for the desired entry.

1. On the Home screen, select .
2. Press **Search**.
3. Enter the name you want to search for.

Deleting a Phonebook Entry

You can delete phonebook entries.

1. On the Home screen, select .
2. Press **[▲]** or **[▼]** to display the desired entry, or press **Search** and search for the desired entry (Page 35).
3. Press **Delete**, and then press **Yes**.

Export/Import Phonebook Entries

You can export the phonebook entries through the Web user interface to your computer. This makes it possible to add and edit phonebook entries using a spreadsheet application or text editor on your computer. After editing, the file should be imported into the unit.

Also, phonebook entries exported from one unit can be imported into another, which makes it easy to share phonebook entries.

For information on exporting, importing, and editing entries, consult your administrator or dealer.

Note

- If you export the phonebook, delete some entries on your computer, and then import the phonebook to the unit, the entries deleted on your computer will not be deleted from the unit's phonebook. To erase unnecessary entries, use the unit's interface and not the Web user interface.
- If you import a phonebook with more than 1,000 entries, an error message is displayed and only the first 1,000 entries in the phonebook are imported.
- Phone calls cannot be made or received while phonebook entries are being imported or exported.

Local Phonebook

The phonebook stored on the unit is referred to as Local Phonebook. If other types of phonebooks, such as LDAP phonebook, are available, use the steps below to access the local phonebook.

1. On the Home screen, select .
2. Press **[▲]** or **[▼]** to select "Local Phonebook", and then press **[ENTER]**.

LDAP Phonebook

LDAP phonebook is a phonebook linked with an LDAP server. If your unit is configured to use LDAP, you can access phonebook entries on the LDAP server. LDAP phonebook entries cannot be added, edited, or deleted from the unit. LDAP is an optional feature and may not be available. For more information, consult your administrator or dealer.

Making a Call from the LDAP Phonebook List

1. On the Home screen, select .
2. Press **[▲]** or **[▼]** to select "LDAP Phonebook", and then press **[ENTER]**.
3. Press **[▲]** or **[▼]** to select the entry.
4. Press **Call**.

Searching for an LDAP Phonebook Entry

1. On the Home screen, select .
2. Press **[▲]** or **[▼]** to select "LDAP Phonebook", and then press **[ENTER]**.
3. Press **Search**.

Enterprise Phonebook

Enterprise phonebook is a server based phonebook that can be accessed through the Services function. The Application Settings (Page 39) must be configured in order to use Enterprise phonebook. Enterprise phonebook entries cannot be added, edited, or deleted from the unit. Enterprise phonebook is an optional feature and may not be available. For information about availability and the required settings, consult your administrator or dealer.

Making a Call from the Enterprise Phonebook List

1. On the Home screen, select .
2. Press **[▲]** or **[▼]** to select "Directories", and then press **[ENTER]**.
3. Press **[▲]** or **[▼]** to select the entry.

4. Press **Call**.

Searching for an Enterprise Phonebook Entry

1. On the Home screen, select .
2. Press **[▲]** or **[▼]** to select "Directories", and then press **[ENTER]**.
3. Press **Search**.

User Settings

You can configure various settings to customize the behavior of the unit. This section explains how to configure the settings using the unit.

Accessing the Settings

1. On the Home screen, select .
2. Press **[▲]** or **[▼]** to select the desired setting category, and then press **[ENTER]**.
3. Configure the settings as necessary.

Available Settings

Basic Phone Settings

Menu Item	Setting	Ref.
Date and Time	Date	Page 40
	Date Template	Page 40
	Time	Page 40
	Use 12-hour Format	Page 40
Ringtone	—	Page 41
Language	—	Page 41
Brightness	—	Page 41
Hotline	Enable Hotline	Page 41
	Phone Number	Page 41
	Delay Time (0-10)	Page 41
Call Block	—	Page 42
Display Lock	—	Page 42
Key Click Tone	—	Page 42
ECO Mode	—	Page 43

Basic Call Features

Menu Item	Setting	Ref.
FWD/DND Setting	Do Not Disturb	Page 43
	Enable FWD All	Page 43
	FWD All Number	Page 43
	Enable FWD Busy	Page 43

Menu Item	Setting	Ref.
	FWD Busy Number	Page 43
	Enable FWD No Ans	Page 43
	FWD No Ans Number	Page 43
	FWD No Ans Ring Count	Page 44
Block Anonymous Call	—	Page 44

Information Display

Displays a variety of information about the unit. See Page 44 for more information.

Network Settings

Menu Item	Setting	Sub-Setting	Ref.	
Network	IP Address Mode	—	Page 45	
	IPv4	Enable DHCP		Page 45
		IP Address		Page 45
		Subnet Mask		Page 45
		Default Gateway		Page 45
		Auto DNS		Page 45
		DNS1		Page 45
		DNS2		Page 45
	IPv6	Enable IPv6 DHCP		Page 45
		Allow Auto Configuration		Page 45
		Enable IPv6 Privacy		Page 45
		IPv6 Address		Page 45
		IPv6 Prefix Length		Page 45
		IPv6 Default Gateway		Page 45
		IPv6 Auto DNS		Page 45
IPv6 DNS1			Page 45	
IPv6 DNS2		Page 46		
LLDP Settings	Enable LLDP	—	Page 46	
	LLDP-MED Interval timer	—	Page 46	
CDP Settings	Enable CDP	—	Page 46	
	CDP Interval timer	—	Page 46	
VLAN Settings	Enable IP Phone VLAN	—	Page 46	

Menu Item	Setting	Sub-Setting	Ref.	
	IP Phone VLAN ID	—	Page 46	
	Enable PC VLAN	—	Page 46	
	PC VLAN ID	—	Page 46	
802.1x	Enable 802.1x	—	Page 46	
	Authentication Protocol	—	Page 46	
	Authentication ID	—	Page 46	
	Authentication Password	—	Page 46	
Speed/Duplex	LAN Port	—	Page 47	
	PC Port	—	Page 47	
Embedded Web	—	—	Page 47	
Port Mirroring	—	—	Page 47	
HTTP Authentication	User ID	—	Page 48	
	Password	—	Page 48	
Provisioning	Enable Provisioning	—	Page 48	
	Provision Server	—	Page 48	
	User ID	—	Page 48	
	Password	—	Page 48	
	Enable SIP PnP	—	Page 48	
	DHCP Options	Enable Option 160	—	Page 48
		Enable Option 159	—	Page 48
		Enable Option 66	—	Page 48
DHCPv6 Options	Enable Sub Option 1	—	Page 48	
Multicast Paging	Paging DND	—	Page 48	

Application Settings

Menu Item	Setting	Ref.
Enable Application	—	Page 48
Application Server	—	Page 48
Service URL	—	Page 48
User ID	—	Page 49
User Password	—	Page 49

Network Test

Menu Item	Setting	Ref.
IP Address	—	Page 49
IPv6 Address	—	Page 49

Reset

Menu Item	Setting	Ref.
Exclude Private Settings	—	Page 49
Exclude Network Settings	—	Page 49

Restart

The unit can be restarted as necessary. See Page 49 for more information.

Settings Details

Basic Phone Settings

Date and Time

Setting	Description	Value Range	Default
Date	Set the date.	—	2013/10/02
Date Template	Set the date format.	mm/dd dd/mm dd/mm/yyyy dd/mm/yy mm/dd/yyyy mm/dd/yy yyyy/mm/dd yy/mm/dd	mm/dd
Time	Set the time.	—	10:01
Use 12-hour Format	Set the time format to 12-hour or 24-hour time. Select "Yes" to use 12-hour time and "No" to use 24-hour time.	Yes, No	Yes

Note

- Daylight-saving time can be set through Web user interface programming. For details, consult your administrator or dealer.

Ringtone

Setting	Description	Value Range	Default
Ringtone	Select a ringtone to play when you receive a call. If multiple lines are configured on your unit, you must first select which line to use the ringtone for. You can assign a different ringtone to each line. If you select "Automatic", the ringtone assigned through Web user interface programming (Page 52) will be used. Press Play to listen to the highlighted ringtone.	Automatic, Silence, Ringtone 1– Ringtone 9	Automatic

Note

- Ringtones can also be assigned to individual entries in the phonebook list (Page 34).

Language

Setting	Description	Value Range	Default
Language	Select the language to use for the display.	English(US)	English(US)

Brightness

Setting	Description	Value Range	Default
Brightness	Press [▲] or [▼] to adjust the brightness.	Level 1 to 14	Level 7

Hotline

Setting	Description	Value Range	Default
Enable Hotline	Enable or disable the hotline.	On, Off	Off
Phone Number	Enter the hotline phone number.	1-32 digits	—
Delay Time (0-10)	Select the delay time.	0-10	5

Call Block

Setting	Description	Value Range	Default
Call Block	<p>Register telephone numbers so that calls received from those numbers are blocked. You can also delete registered numbers.</p> <p>To register</p> <ol style="list-style-type: none"> 1. Press Add. 2. Enter the telephone number to block, and then press Save. <p>To edit</p> <ol style="list-style-type: none"> 1. Press [▲] or [▼] to select the blocked telephone number to edit. 2. Press Edit. 3. Edit the number as necessary, and then press Save. <p>To delete</p> <ol style="list-style-type: none"> 1. Press [▲] or [▼] to select the blocked telephone number to delete. 2. Press Delete. 3. Press Yes. 	—	—

Display Lock

Setting	Description	Value Range	Default
Display Lock	Lock access to your call log and phonebook list by entering your extension PIN (Personal Identification Number).	On, Off	Off

Note

- The extension PIN can be configured through Web user interface programming. For details, consult your administrator or dealer.

Key Click Tone

Setting	Description	Value Range	Default
Key Click Tone	Select the volume of the tone that is heard in response to key presses.	High, Middle, Low, Off	High

ECO Mode

Setting	Description	Value Range	Default
ECO Mode	Enabling this mode reduces the amount of electricity consumed by the unit.	On, Off	Off

Note

- When ECO mode is enabled, the Speed/Duplex setting (Page 47) for LAN Port and PC Port changes as follows:
 - Speed/Duplex: "10M-Full"
 - PC port cannot be used.
- When the ECO mode setting is changed, the unit will restart.
- When ECO mode is enabled,  is displayed in the status bar at the top of the screen.

Basic Call Features

FWD/DND Setting

If multiple lines are available at your unit, press [▲] or [▼] to select the line to apply the settings to when you select "FWD/DND Setting" and "Block Anonymous Call".

Setting	Sub-Setting	Description	Value Range	Default
FWD/DND Setting	Do Not Disturb	Enable DND (Do Not Disturb) to reject all incoming calls.	On, Off	Off
	Enable FWD All	Enable or disable forwarding of all incoming calls to a specified destination.	On, Off	Off
	FWD All Number	Specify the number to forward calls to when "Enable FWD All" is enabled.	1-32 digits	—
	Enable FWD Busy	Enable or disable forwarding of incoming calls to a specified destination when you are on a call.	On, Off	Off
	FWD Busy Number	Specify the number to forward calls to when "Enable FWD Busy" is enabled.	1-32 digits	—
	Enable FWD No Ans	Enable or disable forwarding of incoming calls to a specified destination if you do not answer after a specified number of rings.	On, Off	Off
	FWD No Ans Number	Specify the number to forward calls to when "Enable FWD No Ans" is enabled.	1-32 digits	—

Setting	Sub-Setting	Description	Value Range	Default
	FWD No Ans Ring Count	Specify the number of times the unit will ring before forwarding the call.	0, 2-20	3
Block Anonymous Call	—	Enable or disable blocking of all anonymous calls.	On, Off	Off

Information Display

Setting	Description	Value Range	Default
Information Display	<p>View a variety of information about the unit. Press [▲] and [▼] to display the various settings. The following settings can be viewed:</p> <ul style="list-style-type: none"> • Firmware Version • MAC Address • Line status • IP Address • Subnet Mask • Default Gateway • DNS1 • DNS2 • IPv6 Address • IPv6 Prefix Length • IPv6 Default Gateway • IPv6 DNS1 • IPv6 DNS2 • IP Phone VLAN ID • PC VLAN ID • IEEE802.1X Status • Display Lock 	—	—

Network Settings

IMPORTANT

We recommend configuring these settings with your administrator or dealer. Network settings can also be configured through Web user interface programming (Page 52). Contact your administrator or dealer for further information.

Network

Setting	Sub-Setting	Description	Value Range	Default
IP Address Mode	—	Specify the IP address mode to use.	IPv4 only IPv6 only Dual stack	Dual stack
IPv4	Enable DHCP	Enable or disable DHCP for IPv4.	Yes, No	Yes
	IP Address	If DHCP is not enabled, you must specify the IP address.	xxx.xxx.xxx.xxx	—
	Subnet Mask	If DHCP is not enabled, you must specify the subnet mask.	xxx.xxx.xxx.xxx	—
	Default Gateway	If DHCP is not enabled, you must specify the default gateway.	xxx.xxx.xxx.xxx	—
	Auto DNS	Enable or disable Auto DNS for IPv4.	Yes, No	Yes
	DNS1	If Auto DNS is not enabled, you can specify the primary DNS server IP address.	xxx.xxx.xxx.xxx	—
	DNS2	If Auto DNS is not enabled, you can specify the secondary DNS server IP address. Leave blank if a secondary DNS server is not used.	xxx.xxx.xxx.xxx	—
IPv6	Enable IPv6 DHCP	Enable or disable DHCP for IPv6.	Yes, No	Yes
	Allow Auto Configuration	Enable or disable auto configuration for IPv6.	Yes, No	Yes
	Enable IPv6 Privacy	Enable or disable privacy for IPv6.	Yes, No	No
	IPv6 Address	If DHCP is not enabled, you must specify the IP address.	1-46 characters	—
	IPv6 Prefix Length	If DHCP is not enabled, you must specify the prefix length.	1-128	—
	IPv6 Default Gateway	If DHCP is not enabled, you must specify the default gateway.	1-46 characters	—
	IPv6 Auto DNS	Enable or disable Auto DNS for IPv6.	Yes, No	Yes
	IPv6 DNS1	If IPv6 Auto DNS is not enabled, you can specify the primary DNS server IP address.	1-46 characters	—

Setting	Sub-Setting	Description	Value Range	Default
	IPv6 DNS2	If IPv6 Auto DNS is not enabled, you can specify the secondary DNS server IP address. Leave blank if a secondary DNS server is not used.	1-46 characters	—

LLDP Settings

Setting	Description	Value Range	Default
Enable LLDP	Enable or disable LLDP ^{*1} .	Yes, No	No
LLDP-MED Interval timer	Specify the LLDP-MED ^{*1} interval timer.	5-3600 seconds	30

*1 LLDP: Link Layer Discovery Protocol, MED: Media Endpoint Discovery

CDP Settings

Setting	Description	Value Range	Default
Enable CDP	Enable or disable CDP.	Yes, No	No
CDP Interval timer	Specify the CDP interval timer.	5-3600 seconds	30

VLAN Settings

Setting	Description	Value Range	Default
Enable IP Phone VLAN	Enable or disable VLAN (Virtual LAN) settings.	Yes, No	No
IP Phone VLAN ID	Specify the VLAN ID.	NULL, 0-4094	2
Enable PC VLAN	Enable or disable PC over a VLAN (Virtual LAN).	Yes, No	No
PC VLAN ID	Specify the PC VLAN ID.	NULL, 0-4094	1

802.1x

Setting	Description	Value Range	Default
Enable 802.1x	Enable or disable 802.1x.	Yes, No	No

Setting	Description	Value Range	Default
Authentication Protocol	Select the authentication protocol.	EAP-MD5 EAP-TLS EAP-FAST EAP-PEAP-GTC EAP-PEAP-MSCHAPv2 EAP-TTLS-GTC EAP-TTLS-MSCHAPv2	EAP-MD5
Authentication ID	Enter the authentication ID.	1-127 characters	—
Authentication Password	Enter the authentication password.	1-127 characters	—

Speed/Duplex

Select the connection mode (combination of link speed and duplex mode) of the LAN port and PC port.

Setting	Description	Value Range	Default
LAN Port	Select the connection mode of the LAN port.	Auto 10M-Half 10M-Full 100M-Half 100M-Full 1000M-Full	Auto
PC Port	Select the connection mode of the PC port.	Auto 10M-Half 10M-Full 100M-Half 100M-Full 1000M-Full	Auto

Embedded Web

Setting	Description	Value Range	Default
Embedded Web	Enable or disable Web User Interface Programming.	On, Off	Off

Port Mirroring

Setting	Description	Value Range	Default
Port Mirroring	Enable or disable port mirroring.	On, Off	Off

HTTP Authentication

Setting	Description	Value Range	Default
User ID	Enter the authentication ID.	1-127 characters	—
Password	Enter the authentication password.	1-127 characters	—

Provisioning

Setting	Sub-Setting	Description	Value Range	Default
Enable Provisioning	—	Enable or disable provisioning.	Yes, No	Yes
Provision Server	—	Enter the provisioning server's URL.	1-1024 characters	—
User ID	—	Enter the provisioning ID.	1-127 characters	—
Password	—	Enter the provisioning password.	1-127 characters	—
Enable SIP PnP	—	Enable or disable SIP PnP.	Yes, No	Yes
DHCP Options	Enable Option 160	Enable or disable DHCP Option 160.	Yes, No	Yes
	Enable Option 159	Enable or disable DHCP Option 159.	Yes, No	Yes
	Enable Option 66	Enable or disable DHCP Option 66.	Yes, No	Yes
DHCPv6 Options	Enable Sub Option 1	Enable or disable Sub Option 1.	Yes, No	Yes

Multicast Paging

Setting	Description	Value Range	Default
Paging DND	Enable or disable paging DND.	On, Off	Off

Application Settings

Setting	Description	Value Range	Default
Enable Application	Enable or disable application settings.	Yes, No	No
Application Server	Select the type of application server.	Broadsoft Switchvox	Broadsoft
Service URL	Enter the service URL.	1-128 characters	—

Setting	Description	Value Range	Default
User ID	Enter the user ID.	1-64 characters	—
User Password	Enter the user password.	1-64 characters	—

Network Test

Confirm whether other network devices (e.g., SIP server, routers, switching hubs) respond to network requests. If a device does not respond, first check the unit's network settings, and then check the device's network settings and connection.

Setting	Description	Value Range	Default
IP Address	Enter the IPv4 address of the device to which you want to test the connection, and then press Ping .	xxx.xxx.xxx.xxx	—
IPv6 Address	Enter the IPv6 address of the device to which you want to test the connection, and then press Ping .	1-46 characters	—

Reset

Setting	Description	Value Range	Default
Exclude Private Settings	Reset all settings excluding private settings (Page 64). Private settings include ringtone volume, brightness, phonebook, and call history.	—	—
Exclude Network Settings	Reset all settings excluding network settings (Page 64). Private settings are also reset when Exclude Network Settings is executed.	—	—

Restart

Setting	Description	Value Range	Default
Restart	Restart the unit (Page 64).	—	—

Entering Characters

The dial keys are used to enter characters and numbers. Each dial key has multiple characters assigned to it. (For example, a, b and c are assigned to the 1 key.)

To enter a character, press the corresponding dial key until the character you want appears. To enter another character that is assigned to the same key, first press [▶] to move the cursor to the right.

Example

To enter "desk", press the keys as follows:

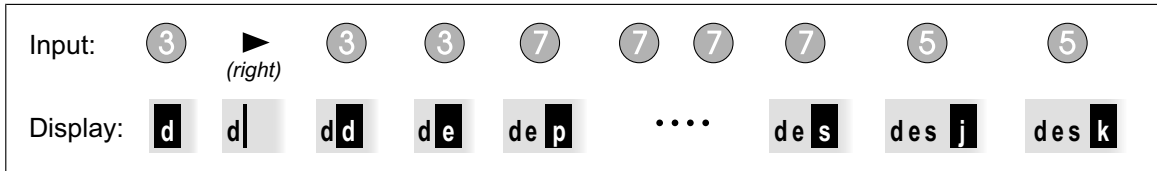

For details about the characters assigned to each key, see "Character Table (Page 50)".

Deleting characters

Press **Backspace** to delete the last character entered.



Modifying entered text

Use [◀] and [▶] to move the cursor to where you want to modify the text. Then, modify the text as follows:

- Press **Backspace** to delete the character to the left of the cursor.



- Press a dial key to insert a character at the cursor's location.



Note

- Depending on the type of information you are entering, you cannot enter certain characters. For example, when you are entering a phone number, only numeric characters can be entered.

Character Table

Button	Characters
①	/ . @ 1 : ; = ? - _ & %
②	a b c 2 A B C
③	d e f 3 D E F

Button	Characters
④	g h i 4 G H I
⑤	j k l 5 J K L
⑥	m n o 6 M N O
⑦	p q r s 7 P Q R S
⑧	t u v 8 T U V
⑨	w x y z 9 W X Y Z
①	<Space> 0 , ! ^ ' "
⊛	+ * ~ ' < >
#	# \$ \ () { } []

Web User Interface Programming

The unit provides a Web-based interface for configuring various settings and features, including some that are not programmable directly from the unit. The following list contains some useful features that are programmable through the Web user interface.

For details, consult your administrator or dealer.

- Basic network settings^{*1} (Page 38)
- User password (for access to Web user interface)
- HTTP authentication settings
- Date and time settings^{*1} (Page 40)
- Default outgoing line
- Call rejection phone numbers^{*1} (Page 42)
- Block caller ID
- Block anonymous calls
- Do Not Disturb^{*1} (Page 43)
- Call forward^{*1} (Page 43)
- Flexible button settings (Page 29) (One-Touch, BLF, etc.)
- Key click tone
- Extension PIN
- Phonebook import and export (Page 35)

^{*1} These settings can also be configured directly through the unit.

Notice

- Each time you want to access the Web user interface, you must enable Web programming (Page 47).
- Available settings depend on the user level and configuration file settings used.

Installation and Setup

Notice

- Panasonic assumes no responsibility for injuries or property damage resulting from failures arising out of improper installation or operation inconsistent with this documentation.

Attaching/Removing the Stand

Attaching the Stand

Notice

- If you place the display face down when you attach the stand, be sure to place a soft cloth under the display. Failure to do so may result in damage to the display.
1. Insert the catches (A) of the stand into hooks located in the unit.
 2. Gently push the stand in the direction indicated until it locks into place. The stand will be mounted in the high position.

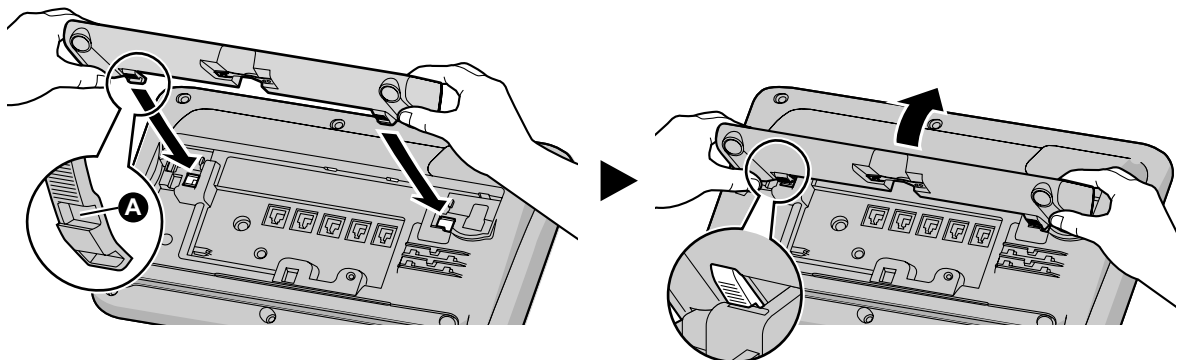

Removing the Stand

1. Hold the stand with both hands.
2. Gently rotate the stand in the direction indicated until it is released.

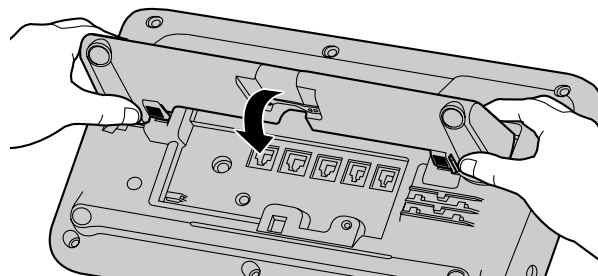

Adjusting from High to Low Position

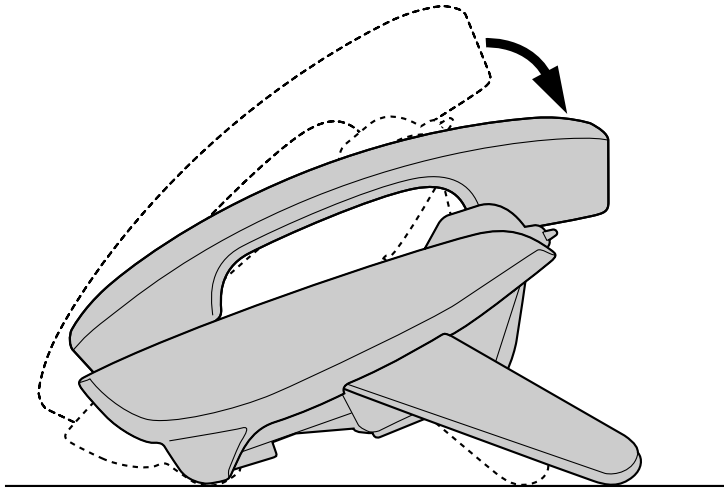

1. Tilt the stand in the direction indicated while pushing the PUSH mark with both hands as shown until it locks into the low position (B).

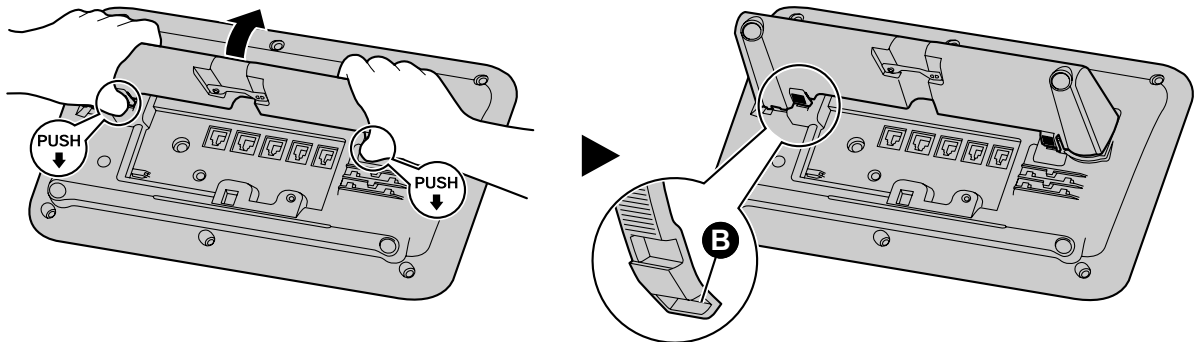

Adjusting from Low to High Position

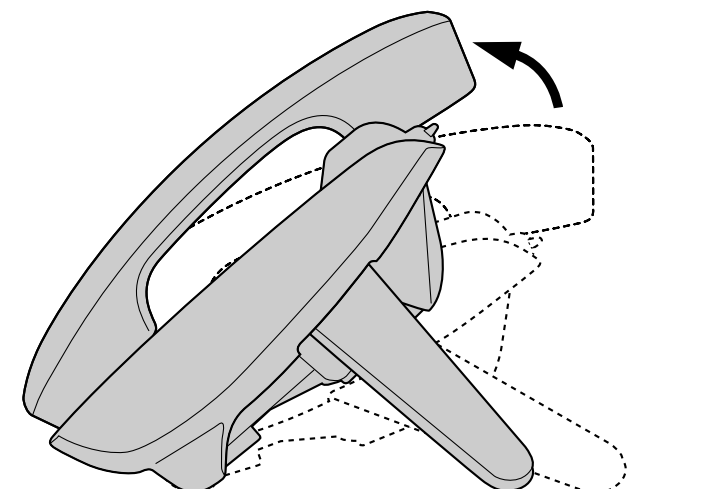

1. Tilt the stand in the direction indicated while pushing the PUSH mark with both hands as shown until it locks into the high position (A).

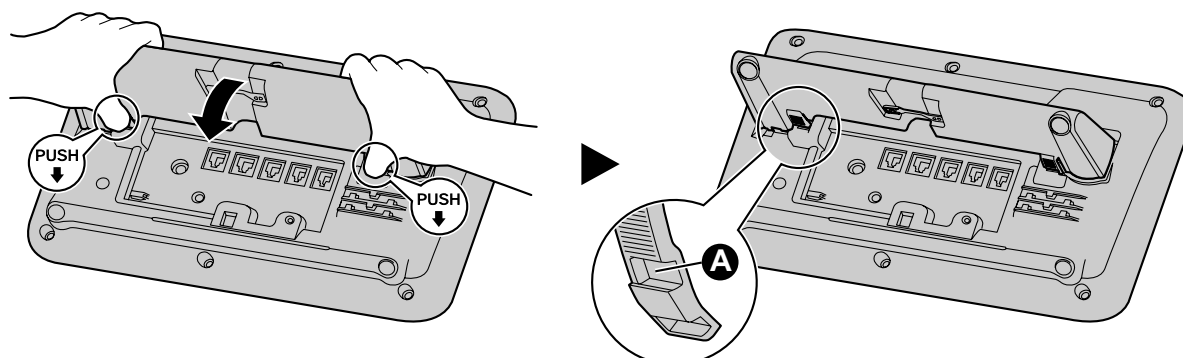

Connections

This section explains the ports and connectors on the unit.

Connections for AC Adaptor/LAN/PC

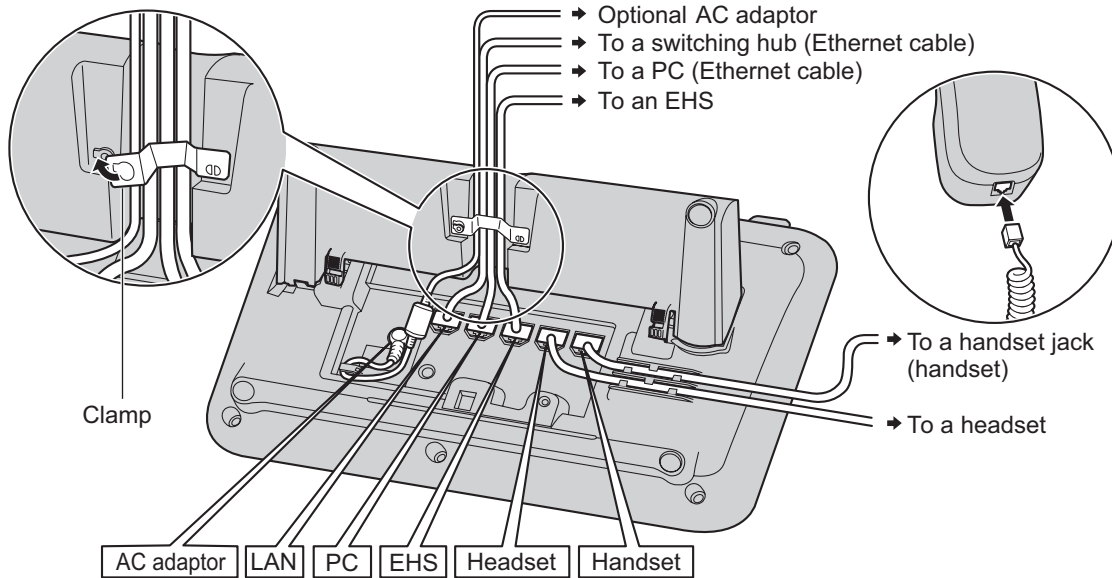

CAUTION

Optional AC Adaptor

- Use the following AC adaptor:
 - DSA-42D-48 2 480063 (P/N: 381.00398.005)
- The AC adaptor is used as the main disconnect device. Ensure that the AC outlet is installed near the unit and is easily accessible.

When connecting a headset

- Ensure that the headset cord has slack and is not pulled tight during use to prevent damage to the connectors.
- Cords used to connect devices to the EHS jack or headset jack must be less than 3 m (9.8 ft) in length.

Notice

- The following headsets can be used with this unit. (Not all operations with the headsets can be guaranteed.)
 - EHS headsets
 - Selected Plantronics®-brand headsets
 - Selected Jabra®-brand headsets

For up-to-date information about headsets that have been tested with this unit, refer to the following web site:

<http://www.panasonic.com/sip>

When connecting the Ethernet cable

- Connect the cables as shown in the following illustration.

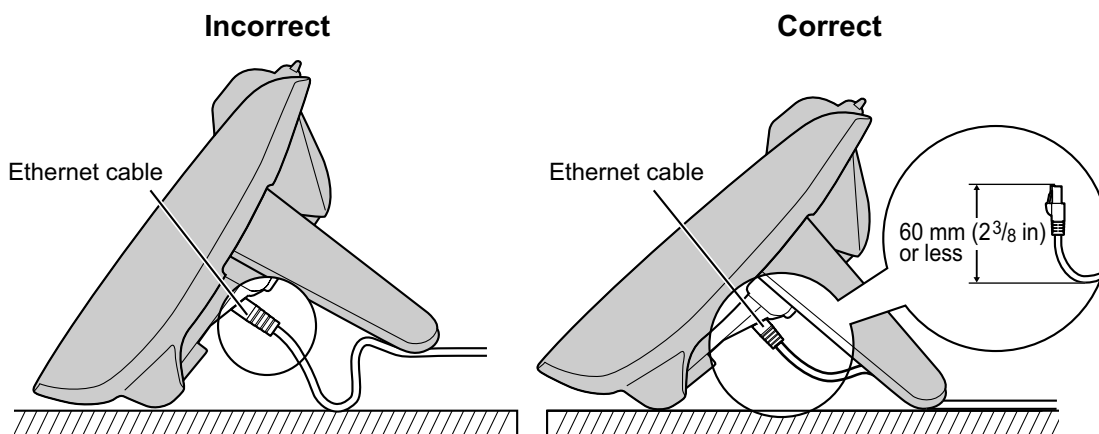

- Use the included Ethernet cable.

When connecting to a switching hub

- If PoE is available, an AC adaptor is not needed.
- This unit complies with the PoE Class 2 standard.

When connecting a PC

- Only a PC can be connected to the PC port. Other SIP phones, or network devices such as routers or switching hubs, cannot be connected.
- The PC port does not support PoE for connected devices.

When connecting cables and the AC adaptor

- Ensure that the Ethernet cables and the AC adaptor cord are clamped to prevent damage to the connectors.

Connections for Handset

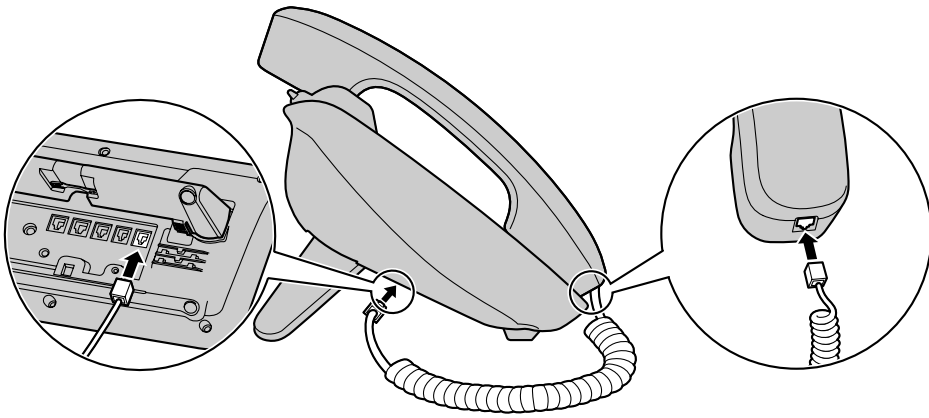

Wall Mounting

Before Mounting on a Wall

To mount the unit, it is necessary to remove the stand. For details, see "Removing the Stand (Page 53)".

Mounting the Unit

WARNING

- Do not mount the unit in a manner other than that described in this section.
- Make sure that the wall that the unit will be attached to is strong enough to support the unit. If not, it is necessary for the wall to be reinforced. For information about the weight of the unit, see "Specifications (Page 81)".
- Only use the optional wall mount kit with the unit. The wall mount kit includes the necessary screws, washers, and wall mounting adaptor.
- When driving the screws into the wall, be careful to avoid touching any metal laths, wire laths, or metal plates in the wall.
- When this unit is no longer in use, make sure to detach it from the wall.

CAUTION

- Make sure the cables are securely fastened to the wall.

Notice

- If you place the display face down when you attach the wall mounting adaptor, be sure to place a soft cloth under the display before attaching the adaptor. Failure to do so may result in damage to the display.

1. Insert the 5 tabs of the wall mounting adaptor into the designated openings in the base, and then slide the wall mounting adaptor in the direction of the arrow until it clicks.

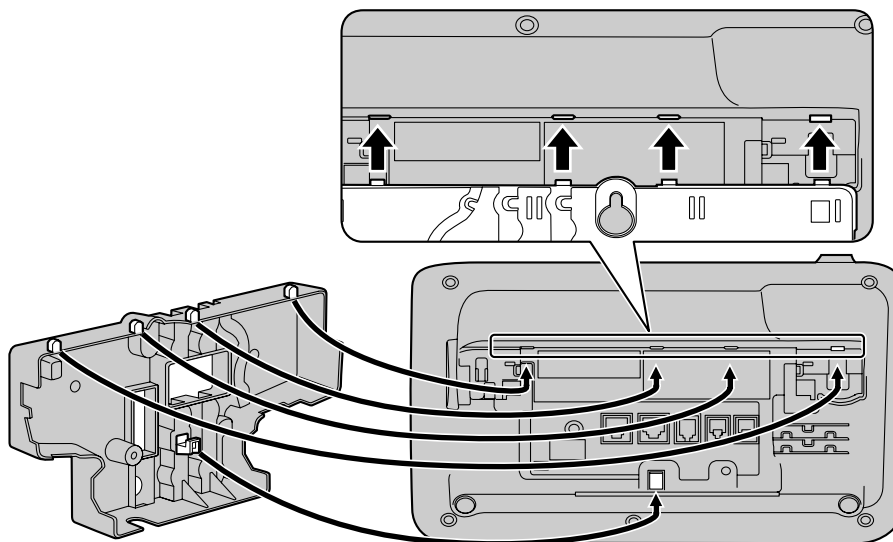

2. Fasten the wall mounting adaptor to the base with 1 screw. (Recommended torque: 0.4 N·m [4.08 kgf·cm/ 3.54 lbf·in] to 0.6 N·m [6.12 kgf·cm/5.31 lbf·in])

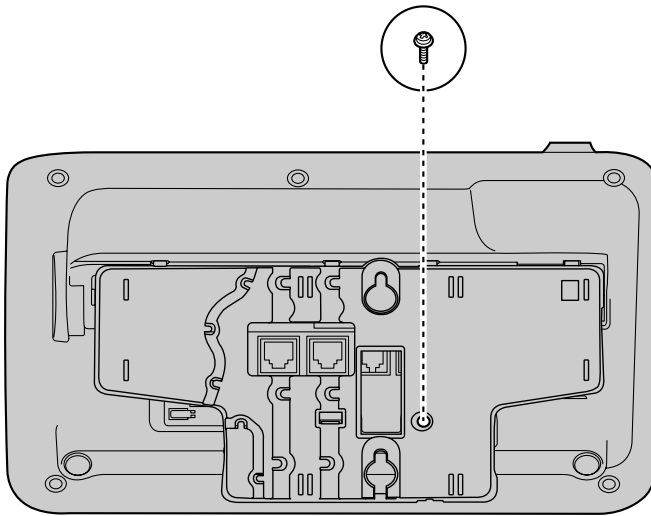

3. Connect the cables to the unit, and run the cables through the wall mounting adaptor, as shown in the illustration below.
For details about connecting the cables, see "Connections (Page 56)".

Note

- The cables can also be run from the bottom of the unit.

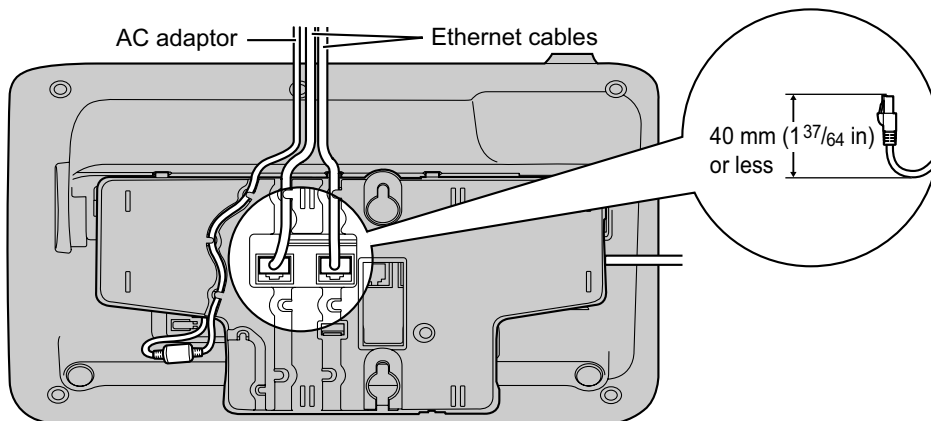

4. Drive the 2 screws into the wall either 83 mm (3 1/4 in) or 100 mm (3 15/16 in) apart, and mount the unit on the wall.

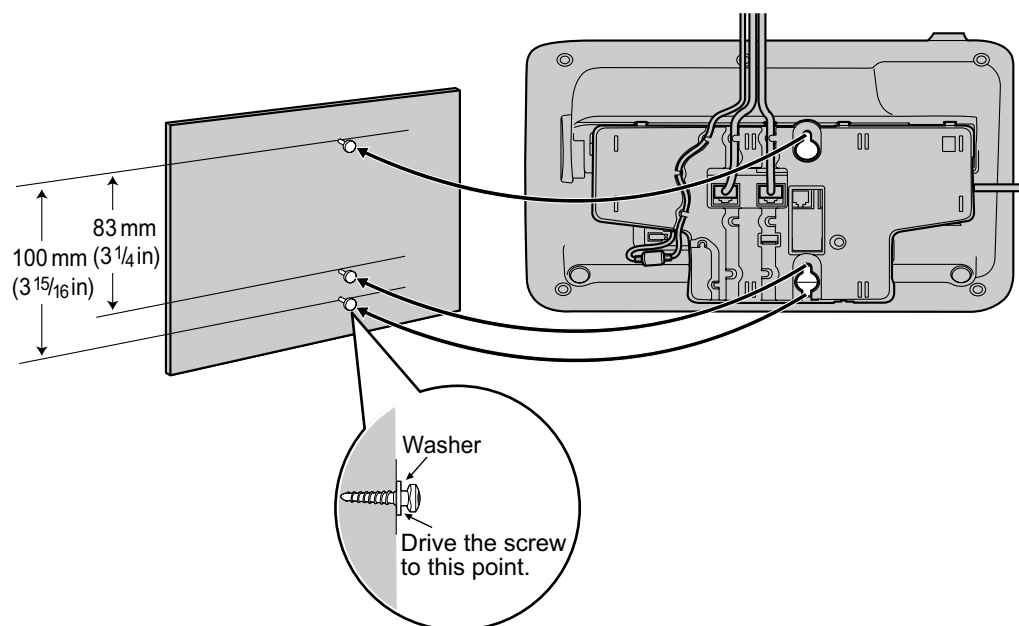
**Note**

- You can find a wall mounting template at the end of this manual.
- For information about locking the handset, see "Hooking the Handset (Page 62)".

Hooking the Handset

You can hook the handset with the following operations.

To Hook the Handset During a Conversation

1. Hook the handset over the top edge of the unit.

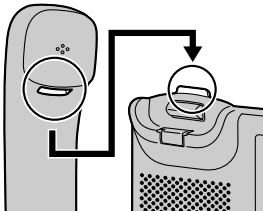

To Lock the Handset Hook when the Unit is Wall Mounted

1. Remove the handset hook from the slot.

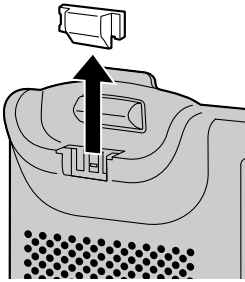

2. Turn it upside-down.

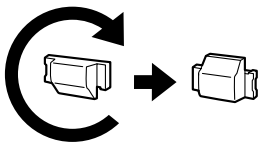

3. Slide the handset hook back into the slot until it locks.

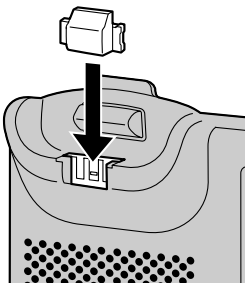

4. Handset is safely hooked when it is in the cradle.

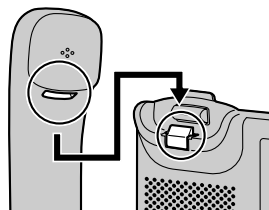

Using a Headset

If a headset is connected, you must enable Headset mode by pressing [HEADSET].

Note

- The Headset button light shows the current status as follows:
Off: Headset mode off
Red: Headset mode on

Setting Up the Unit

The user settings can be used to setup the unit by configuring the settings as required. See Page 37 for information about the settings.

Maintaining the Unit

Resetting the Unit

Resetting all settings except for private settings

Executing "Exclude Private Settings" resets all settings except for private settings. Private settings include ringtone volume, brightness, phonebook, and call history.

1. On the Home screen, select .
2. Press [▲] or [▼] to select "Reset", and then press [ENTER].
3. Press [▲] or [▼] to select "Exclude Private Settings", and then press [ENTER].
4. Press .
 - To cancel, press .

Resetting all settings except for network settings

Executing "Reset Excluding Network Settings" resets all settings except for network settings. Private settings are reset in this case. Network settings include IPv4, IPv6, LLDP Settings, CDP Settings, VLAN Settings, Speed/Duplex, and Port Mirroring.

1. On the Home screen, select .
2. Press [▲] or [▼] to select "Reset", and then press [ENTER].
3. Press [▲] or [▼] to select "Reset Excluding Network Settings", and then press [ENTER].
4. Press .
 - To cancel, press .

Restarting the Unit

When some of the settings on the unit have been changed via Web user interface programming or configuration file programming, the unit must be restarted.

1. On the Home screen, select .
2. Press [▲] or [▼] to select "Restart", and then press [ENTER].
3. Press .
 - To cancel, press .

Cleaning the Unit

Clean the unit periodically by wiping it with a soft and dry cloth.



When cleaning the unit, observe the following precautions.

When cleaning the display

- Wipe the display with only the following types of materials:
 - A soft and dry cloth.
 - A soft cloth with a very small quantity of neutral detergent or ethyl alcohol.
- Do not press or rub the display with too much force.

When cleaning the body

- To avoid damaging the unit, disconnect the Ethernet cable and all other cables from the unit before cleaning. If the unit is powered with an AC adaptor, disconnect the AC adaptor from the unit and power outlet before cleaning.
- If the unit becomes particularly dirty, apply a light kitchen cleanser to a soft cloth, wring the cloth thoroughly, and then wipe the unit. When finished, dry the unit with a soft and dry cloth.
- To avoid damage or discoloration, do not clean the unit with any of the following materials or with cleaners that contain any of the following materials:
 - Petroleum
 - Scouring powder
 - Alcohol
 - Paint thinner
 - Benzene
 - Wax
 - Hot water
 - Powdered soap
- When using chemical cleansers, follow the instructions on the label carefully.

Open Source Software

Parts of this product use Open Source Software. Relevant conditions apply to this software. Panasonic cannot accept inquiries regarding the content of the following copyright and license information.

<<dropbear-0.52>>

Copyright (c) 2002-2013 Matt Johnston
Portions copyright (c) 2004 Mihnea Stoenescu
All rights reserved.

Permission is hereby granted, free of charge, to any person obtaining a copy of this software and associated documentation files (the "Software"), to deal in the Software without restriction, including without limitation the rights to use, copy, modify, merge, publish, distribute, sublicense, and/or sell copies of the Software, and to permit persons to whom the Software is furnished to do so, subject to the following conditions:

The above copyright notice and this permission notice shall be included in all copies or substantial portions of the Software.

THE SOFTWARE IS PROVIDED "AS IS", WITHOUT WARRANTY OF ANY KIND, EXPRESS OR IMPLIED, INCLUDING BUT NOT LIMITED TO THE WARRANTIES OF MERCHANTABILITY, FITNESS FOR A PARTICULAR PURPOSE AND NONINFRINGEMENT. IN NO EVENT SHALL THE AUTHORS OR COPYRIGHT HOLDERS BE LIABLE FOR ANY CLAIM, DAMAGES OR OTHER LIABILITY, WHETHER IN AN ACTION OF CONTRACT, TORT OR OTHERWISE, ARISING FROM, OUT OF OR IN CONNECTION WITH THE SOFTWARE OR THE USE OR OTHER DEALINGS IN THE SOFTWARE.

=====

LibTomCrypt and LibTomMath are written by Tom St Denis, and are Public Domain.

=====

sshpty.c is taken from OpenSSH 3.5p1,
Copyright (c) 1995 Tatu Ylonen <ylo@cs.hut.fi>, Espoo, Finland
All rights reserved

"As far as I am concerned, the code I have written for this software can be used freely for any purpose. Any derived versions of this software must be clearly marked as such, and if the derived work is incompatible with the protocol description in the RFC file, it must be called by a name other than "ssh" or "Secure Shell". "

=====

loginrec.c
loginrec.h
atomicio.h
atomicio.c
and strlcat() (included in util.c) are from OpenSSH 3.6.1p2, and are licensed under the 2 point BSD license.

loginrec is written primarily by Andre Lucas, atomicio.c by Theo de Raadt.

strlcat() is (c) Todd C. Miller

=====

Import code in keyimport.c is modified from PuTTY's import.c, licensed as follows:

PuTTY is copyright 1997-2003 Simon Tatham.

Portions copyright Robert de Bath, Joris van Rantwijk, Delian Delchev, Andreas Schultz, Jeroen Massar, Wez Furlong, Nicolas Barry, Justin Bradford, and CORE SDI S.A.

Permission is hereby granted, free of charge, to any person obtaining a copy of this software and associated documentation files (the "Software"), to deal in the Software without restriction, including without limitation the rights to use, copy, modify, merge, publish, distribute, sublicense, and/or sell copies of the Software, and to permit persons to whom the Software is furnished to do so, subject to the following conditions:

The above copyright notice and this permission notice shall be included in all copies or substantial portions of the Software.

THE SOFTWARE IS PROVIDED "AS IS", WITHOUT WARRANTY OF ANY KIND, EXPRESS OR IMPLIED, INCLUDING BUT NOT LIMITED TO THE WARRANTIES OF MERCHANTABILITY, FITNESS FOR A PARTICULAR PURPOSE AND NONINFRINGEMENT. IN NO EVENT SHALL THE COPYRIGHT HOLDERS BE LIABLE FOR ANY CLAIM, DAMAGES OR OTHER LIABILITY, WHETHER IN AN ACTION OF CONTRACT, TORT OR OTHERWISE, ARISING FROM, OUT OF OR IN CONNECTION WITH THE SOFTWARE OR THE USE OR OTHER DEALINGS IN THE SOFTWARE.

=====

curve25519-donna:

/* Copyright 2008, Google Inc.

* All rights reserved.

*

* Redistribution and use in source and binary forms, with or without
* modification, are permitted provided that the following conditions are
* met:

*

* * Redistributions of source code must retain the above copyright
* notice, this list of conditions and the following disclaimer.

* * Redistributions in binary form must reproduce the above
* copyright notice, this list of conditions and the following disclaimer
* in the documentation and/or other materials provided with the
* distribution.

* * Neither the name of Google Inc. nor the names of its
* contributors may be used to endorse or promote products derived from
* this software without specific prior written permission.

*

* THIS SOFTWARE IS PROVIDED BY THE COPYRIGHT HOLDERS AND CONTRIBUTORS
* "AS IS" AND ANY EXPRESS OR IMPLIED WARRANTIES, INCLUDING, BUT NOT
* LIMITED TO, THE IMPLIED WARRANTIES OF MERCHANTABILITY AND FITNESS FOR
* A PARTICULAR PURPOSE ARE DISCLAIMED. IN NO EVENT SHALL THE COPYRIGHT
* OWNER OR CONTRIBUTORS BE LIABLE FOR ANY DIRECT, INDIRECT, INCIDENTAL,
* SPECIAL, EXEMPLARY, OR CONSEQUENTIAL DAMAGES (INCLUDING, BUT NOT
* LIMITED TO, PROCUREMENT OF SUBSTITUTE GOODS OR SERVICES; LOSS OF USE,
* DATA, OR PROFITS; OR BUSINESS INTERRUPTION) HOWEVER CAUSED AND ON ANY
* THEORY OF LIABILITY, WHETHER IN CONTRACT, STRICT LIABILITY, OR TORT
* (INCLUDING NEGLIGENCE OR OTHERWISE) ARISING IN ANY WAY OUT OF THE USE
* OF THIS SOFTWARE, EVEN IF ADVISED OF THE POSSIBILITY OF SUCH DAMAGE.

*

* curve25519-donna: Curve25519 elliptic curve, public key function

*

* <http://code.google.com/p/curve25519-donna/>

*

* Adam Langley <agl@imperialviolet.org>

*

* Derived from public domain C code by Daniel J. Bernstein <djb@cr.yp.to>

*

* More information about curve25519 can be found here

* <http://cr.yp.to/ecdh.html>

*

* djb's sample implementation of curve25519 is written in a special assembly
* language called qhasm and uses the floating point registers.

*

* This is, almost, a clean room reimplementation from the curve25519 paper. It

Open Source Software

```
* uses many of the tricks described therein. Only the crecip function is taken
* from the sample implementation.
*/
```

```
<<curl-7.31.0>>
```

COPYRIGHT AND PERMISSION NOTICE

Copyright (c) 1996 - 2014, Daniel Stenberg, <daniel@haxx.se>.

All rights reserved.

Permission to use, copy, modify, and distribute this software for any purpose with or without fee is hereby granted, provided that the above copyright notice and this permission notice appear in all copies.

THE SOFTWARE IS PROVIDED "AS IS", WITHOUT WARRANTY OF ANY KIND, EXPRESS OR IMPLIED, INCLUDING BUT NOT LIMITED TO THE WARRANTIES OF MERCHANTABILITY, FITNESS FOR A PARTICULAR PURPOSE AND NONINFRINGEMENT OF THIRD PARTY RIGHTS. IN NO EVENT SHALL THE AUTHORS OR COPYRIGHT HOLDERS BE LIABLE FOR ANY CLAIM, DAMAGES OR OTHER LIABILITY, WHETHER IN AN ACTION OF CONTRACT, TORT OR OTHERWISE, ARISING FROM, OUT OF OR IN CONNECTION WITH THE SOFTWARE OR THE USE OR OTHER DEALINGS IN THE SOFTWARE.

Except as contained in this notice, the name of a copyright holder shall not be used in advertising or otherwise to promote the sale, use or other dealings in this Software without prior written authorization of the copyright holder.

```
<<c-ares-1.9.1>>
```

Copyright 1998 by the Massachusetts Institute of Technology.

Permission to use, copy, modify, and distribute this software and its documentation for any purpose and without fee is hereby granted, provided that the above copyright notice appear in all copies and that both that copyright notice and this permission notice appear in supporting documentation, and that the name of M.I.T. not be used in advertising or publicity pertaining to distribution of the software without specific, written prior permission. M.I.T. makes no representations about the suitability of this software for any purpose. It is provided "as is" without express or implied warranty.

```
<<expat-1.95.2>>
```

Copyright (c) 1998, 1999, 2000 Thai Open Source Software Center Ltd
and Clark Cooper

Copyright (c) 2001, 2002, 2003, 2004, 2005, 2006 Expat maintainers.
Permission is hereby granted, free of charge, to any person obtaining a copy of this software and associated documentation files (the "Software"), to deal in the Software without restriction, including without limitation the rights to use, copy, modify, merge, publish, distribute, sublicense, and/or sell copies of the Software, and to permit persons to whom the Software is furnished to do so, subject to the following conditions:

The above copyright notice and this permission notice shall be included in all copies or substantial portions of the Software.

THE SOFTWARE IS PROVIDED "AS IS", WITHOUT WARRANTY OF ANY KIND, EXPRESS OR IMPLIED, INCLUDING BUT NOT LIMITED TO THE WARRANTIES OF MERCHANTABILITY, FITNESS FOR A PARTICULAR PURPOSE AND NONINFRINGEMENT. IN NO EVENT SHALL THE AUTHORS OR COPYRIGHT HOLDERS BE LIABLE FOR ANY CLAIM, DAMAGES OR OTHER LIABILITY, WHETHER IN AN ACTION OF CONTRACT, TORT OR OTHERWISE, ARISING FROM, OUT OF OR IN CONNECTION WITH THE SOFTWARE OR THE USE OR OTHER DEALINGS IN THE SOFTWARE.

```
<<openssl-0.9.8x>>
```

LICENSE ISSUES
=====

The OpenSSL toolkit stays under a dual license, i.e. both the conditions of the OpenSSL License and the original SSLeay license apply to the toolkit. See below for the actual license texts. Actually both licenses are BSD-style Open Source licenses. In case of any license issues related to OpenSSL please contact openssl-core@openssl.org.

OpenSSL License

```

-----
/* =====
* Copyright (c) 1998-2011 The OpenSSL Project. All rights reserved.
*
* Redistribution and use in source and binary forms, with or without
* modification, are permitted provided that the following conditions
* are met:
*
* 1. Redistributions of source code must retain the above copyright
* notice, this list of conditions and the following disclaimer.
*
* 2. Redistributions in binary form must reproduce the above copyright
* notice, this list of conditions and the following disclaimer in
* the documentation and/or other materials provided with the
* distribution.
*
* 3. All advertising materials mentioning features or use of this
* software must display the following acknowledgment:
* "This product includes software developed by the OpenSSL Project
* for use in the OpenSSL Toolkit. (http://www.openssl.org/)"
*
* 4. The names "OpenSSL Toolkit" and "OpenSSL Project" must not be used to
* endorse or promote products derived from this software without
* prior written permission. For written permission, please contact
* openssl-core@openssl.org.
*
* 5. Products derived from this software may not be called "OpenSSL"
* nor may "OpenSSL" appear in their names without prior written
* permission of the OpenSSL Project.
*
* 6. Redistributions of any form whatsoever must retain the following
* acknowledgment:
* "This product includes software developed by the OpenSSL Project
* for use in the OpenSSL Toolkit (http://www.openssl.org/)"
*
* THIS SOFTWARE IS PROVIDED BY THE OpenSSL PROJECT ``AS IS" AND ANY
* EXPRESSED OR IMPLIED WARRANTIES, INCLUDING, BUT NOT LIMITED TO, THE
* IMPLIED WARRANTIES OF MERCHANTABILITY AND FITNESS FOR A PARTICULAR
* PURPOSE ARE DISCLAIMED. IN NO EVENT SHALL THE OpenSSL PROJECT OR
* ITS CONTRIBUTORS BE LIABLE FOR ANY DIRECT, INDIRECT, INCIDENTAL,
* SPECIAL, EXEMPLARY, OR CONSEQUENTIAL DAMAGES (INCLUDING, BUT
* NOT LIMITED TO, PROCUREMENT OF SUBSTITUTE GOODS OR SERVICES;
* LOSS OF USE, DATA, OR PROFITS; OR BUSINESS INTERRUPTION)
* HOWEVER CAUSED AND ON ANY THEORY OF LIABILITY, WHETHER IN CONTRACT,
* STRICT LIABILITY, OR TORT (INCLUDING NEGLIGENCE OR OTHERWISE)
* ARISING IN ANY WAY OUT OF THE USE OF THIS SOFTWARE, EVEN IF ADVISED
* OF THE POSSIBILITY OF SUCH DAMAGE.
* =====
*
* This product includes cryptographic software written by Eric Young
* (eay@cryptsoft.com). This product includes software written by Tim
* Hudson (tjh@cryptsoft.com).
*/

```

Original SSLeay License

```

/* Copyright (C) 1995-1998 Eric Young (eay@cryptsoft.com)

```

Open Source Software

```
* All rights reserved.
*
* This package is an SSL implementation written
* by Eric Young (eay@cryptsoft.com).
* The implementation was written so as to conform with Netscapes SSL.
*
* This library is free for commercial and non-commercial use as long as
* the following conditions are aheared to. The following conditions
* apply to all code found in this distribution, be it the RC4, RSA,
* lhash, DES, etc., code; not just the SSL code. The SSL documentation
* included with this distribution is covered by the same copyright terms
* except that the holder is Tim Hudson (tjh@cryptsoft.com).
*
* Copyright remains Eric Young's, and as such any Copyright notices in
* the code are not to be removed.
* If this package is used in a product, Eric Young should be given attribution
* as the author of the parts of the library used.
* This can be in the form of a textual message at program startup or
* in documentation (online or textual) provided with the package.
*
* Redistribution and use in source and binary forms, with or without
* modification, are permitted provided that the following conditions
* are met:
* 1. Redistributions of source code must retain the copyright
* notice, this list of conditions and the following disclaimer.
* 2. Redistributions in binary form must reproduce the above copyright
* notice, this list of conditions and the following disclaimer in the
* documentation and/or other materials provided with the distribution.
* 3. All advertising materials mentioning features or use of this software
* must display the following acknowledgement:
* "This product includes cryptographic software written by
* Eric Young (eay@cryptsoft.com)"
* The word 'cryptographic' can be left out if the rouines from the library
* being used are not cryptographic related :-).
* 4. If you include any Windows specific code (or a derivative thereof) from
* the apps directory (application code) you must include an acknowledgement:
* "This product includes software written by Tim Hudson (tjh@cryptsoft.com)"
*
* THIS SOFTWARE IS PROVIDED BY ERIC YOUNG ``AS IS" AND
* ANY EXPRESS OR IMPLIED WARRANTIES, INCLUDING, BUT NOT LIMITED TO, THE
* IMPLIED WARRANTIES OF MERCHANTABILITY AND FITNESS FOR A PARTICULAR PURPOSE
* ARE DISCLAIMED. IN NO EVENT SHALL THE AUTHOR OR CONTRIBUTORS BE LIABLE
* FOR ANY DIRECT, INDIRECT, INCIDENTAL, SPECIAL, EXEMPLARY, OR CONSEQUENTIAL
* DAMAGES (INCLUDING, BUT NOT LIMITED TO, PROCUREMENT OF SUBSTITUTE GOODS
* OR SERVICES; LOSS OF USE, DATA, OR PROFITS; OR BUSINESS INTERRUPTION)
* HOWEVER CAUSED AND ON ANY THEORY OF LIABILITY, WHETHER IN CONTRACT, STRICT
* LIABILITY, OR TORT (INCLUDING NEGLIGENCE OR OTHERWISE) ARISING IN ANY WAY
* OUT OF THE USE OF THIS SOFTWARE, EVEN IF ADVISED OF THE POSSIBILITY OF
* SUCH DAMAGE.
*
* The licence and distribution terms for any publically available version or
* derivative of this code cannot be changed. i.e. this code cannot simply be
* copied and put under another distribution licence
* [including the GNU Public Licence.]
*/
```

```
<<mcabber-0.10.2>>
```

Copyright \© 2005-2012 Mikael Berthe and others. +

Free use of this software is granted under the terms of the GNU General Public License (GPL).

Specific permission is granted for the GPLed code in this distribution to be linked to OpenSSL without invoking GPL clause 2(b).

GNU GENERAL PUBLIC LICENSE
Version 2, June 1991

Copyright (C) 1989, 1991 Free Software Foundation, Inc.
59 Temple Place, Suite 330, Boston, MA 02111-1307 USA
Everyone is permitted to copy and distribute verbatim copies
of this license document, but changing it is not allowed.

Preamble

The licenses for most software are designed to take away your freedom to share and change it. By contrast, the GNU General Public License is intended to guarantee your freedom to share and change free software--to make sure the software is free for all its users. This General Public License applies to most of the Free Software Foundation's software and to any other program whose authors commit to using it. (Some other Free Software Foundation software is covered by the GNU Library General Public License instead.) You can apply it to your programs, too.

When we speak of free software, we are referring to freedom, not price. Our General Public Licenses are designed to make sure that you have the freedom to distribute copies of free software (and charge for this service if you wish), that you receive source code or can get it if you want it, that you can change the software or use pieces of it in new free programs; and that you know you can do these things.

To protect your rights, we need to make restrictions that forbid anyone to deny you these rights or to ask you to surrender the rights. These restrictions translate to certain responsibilities for you if you distribute copies of the software, or if you modify it.

For example, if you distribute copies of such a program, whether gratis or for a fee, you must give the recipients all the rights that you have. You must make sure that they, too, receive or can get the source code. And you must show them these terms so they know their rights.

We protect your rights with two steps: (1) copyright the software, and (2) offer you this license which gives you legal permission to copy, distribute and/or modify the software.

Also, for each author's protection and ours, we want to make certain that everyone understands that there is no warranty for this free software. If the software is modified by someone else and passed on, we want its recipients to know that what they have is not the original, so that any problems introduced by others will not reflect on the original authors' reputations.

Finally, any free program is threatened constantly by software patents. We wish to avoid the danger that redistributors of a free program will individually obtain patent licenses, in effect making the program proprietary. To prevent this, we have made it clear that any patent must be licensed for everyone's free use or not licensed at all.

The precise terms and conditions for copying, distribution and modification follow.

GNU GENERAL PUBLIC LICENSE
TERMS AND CONDITIONS FOR COPYING, DISTRIBUTION AND MODIFICATION

0. This License applies to any program or other work which contains a notice placed by the copyright holder saying it may be distributed under the terms of this General Public License. The "Program", below, refers to any such program or work, and a "work based on the Program" means either the Program or any derivative work under copyright law: that is to say, a work containing the Program or a portion of it,

either verbatim or with modifications and/or translated into another language. (Hereinafter, translation is included without limitation in the term "modification".) Each licensee is addressed as "you".

Activities other than copying, distribution and modification are not covered by this License; they are outside its scope. The act of running the Program is not restricted, and the output from the Program is covered only if its contents constitute a work based on the Program (independent of having been made by running the Program). Whether that is true depends on what the Program does.

1. You may copy and distribute verbatim copies of the Program's source code as you receive it, in any medium, provided that you conspicuously and appropriately publish on each copy an appropriate copyright notice and disclaimer of warranty; keep intact all the notices that refer to this License and to the absence of any warranty; and give any other recipients of the Program a copy of this License along with the Program.

You may charge a fee for the physical act of transferring a copy, and you may at your option offer warranty protection in exchange for a fee.

2. You may modify your copy or copies of the Program or any portion of it, thus forming a work based on the Program, and copy and distribute such modifications or work under the terms of Section 1 above, provided that you also meet all of these conditions:

- a) You must cause the modified files to carry prominent notices stating that you changed the files and the date of any change.
- b) You must cause any work that you distribute or publish, that in whole or in part contains or is derived from the Program or any part thereof, to be licensed as a whole at no charge to all third parties under the terms of this License.
- c) If the modified program normally reads commands interactively when run, you must cause it, when started running for such interactive use in the most ordinary way, to print or display an announcement including an appropriate copyright notice and a notice that there is no warranty (or else, saying that you provide a warranty) and that users may redistribute the program under these conditions, and telling the user how to view a copy of this License. (Exception: if the Program itself is interactive but does not normally print such an announcement, your work based on the Program is not required to print an announcement.)

These requirements apply to the modified work as a whole. If identifiable sections of that work are not derived from the Program, and can be reasonably considered independent and separate works in themselves, then this License, and its terms, do not apply to those sections when you distribute them as separate works. But when you distribute the same sections as part of a whole which is a work based on the Program, the distribution of the whole must be on the terms of this License, whose permissions for other licensees extend to the entire whole, and thus to each and every part regardless of who wrote it.

Thus, it is not the intent of this section to claim rights or contest your rights to work written entirely by you; rather, the intent is to exercise the right to control the distribution of derivative or collective works based on the Program.

In addition, mere aggregation of another work not based on the Program with the Program (or with a work based on the Program) on a volume of a storage or distribution medium does not bring the other work under the scope of this License.

3. You may copy and distribute the Program (or a work based on it,

under Section 2) in object code or executable form under the terms of Sections 1 and 2 above provided that you also do one of the following:

- a) Accompany it with the complete corresponding machine-readable source code, which must be distributed under the terms of Sections 1 and 2 above on a medium customarily used for software interchange; or,
- b) Accompany it with a written offer, valid for at least three years, to give any third party, for a charge no more than your cost of physically performing source distribution, a complete machine-readable copy of the corresponding source code, to be distributed under the terms of Sections 1 and 2 above on a medium customarily used for software interchange; or,
- c) Accompany it with the information you received as to the offer to distribute corresponding source code. (This alternative is allowed only for noncommercial distribution and only if you received the program in object code or executable form with such an offer, in accord with Subsection b above.)

The source code for a work means the preferred form of the work for making modifications to it. For an executable work, complete source code means all the source code for all modules it contains, plus any associated interface definition files, plus the scripts used to control compilation and installation of the executable. However, as a special exception, the source code distributed need not include anything that is normally distributed (in either source or binary form) with the major components (compiler, kernel, and so on) of the operating system on which the executable runs, unless that component itself accompanies the executable.

If distribution of executable or object code is made by offering access to copy from a designated place, then offering equivalent access to copy the source code from the same place counts as distribution of the source code, even though third parties are not compelled to copy the source along with the object code.

4. You may not copy, modify, sublicense, or distribute the Program except as expressly provided under this License. Any attempt otherwise to copy, modify, sublicense or distribute the Program is void, and will automatically terminate your rights under this License. However, parties who have received copies, or rights, from you under this License will not have their licenses terminated so long as such parties remain in full compliance.

5. You are not required to accept this License, since you have not signed it. However, nothing else grants you permission to modify or distribute the Program or its derivative works. These actions are prohibited by law if you do not accept this License. Therefore, by modifying or distributing the Program (or any work based on the Program), you indicate your acceptance of this License to do so, and all its terms and conditions for copying, distributing or modifying the Program or works based on it.

6. Each time you redistribute the Program (or any work based on the Program), the recipient automatically receives a license from the original licensor to copy, distribute or modify the Program subject to these terms and conditions. You may not impose any further restrictions on the recipients' exercise of the rights granted herein. You are not responsible for enforcing compliance by third parties to this License.

7. If, as a consequence of a court judgment or allegation of patent infringement or for any other reason (not limited to patent issues), conditions are imposed on you (whether by court order, agreement or otherwise) that contradict the conditions of this License, they do not excuse you from the conditions of this License. If you cannot

distribute so as to satisfy simultaneously your obligations under this License and any other pertinent obligations, then as a consequence you may not distribute the Program at all. For example, if a patent license would not permit royalty-free redistribution of the Program by all those who receive copies directly or indirectly through you, then the only way you could satisfy both it and this License would be to refrain entirely from distribution of the Program.

If any portion of this section is held invalid or unenforceable under any particular circumstance, the balance of the section is intended to apply and the section as a whole is intended to apply in other circumstances.

It is not the purpose of this section to induce you to infringe any patents or other property right claims or to contest validity of any such claims; this section has the sole purpose of protecting the integrity of the free software distribution system, which is implemented by public license practices. Many people have made generous contributions to the wide range of software distributed through that system in reliance on consistent application of that system; it is up to the author/donor to decide if he or she is willing to distribute software through any other system and a licensee cannot impose that choice.

This section is intended to make thoroughly clear what is believed to be a consequence of the rest of this License.

8. If the distribution and/or use of the Program is restricted in certain countries either by patents or by copyrighted interfaces, the original copyright holder who places the Program under this License may add an explicit geographical distribution limitation excluding those countries, so that distribution is permitted only in or among countries not thus excluded. In such case, this License incorporates the limitation as if written in the body of this License.

9. The Free Software Foundation may publish revised and/or new versions of the General Public License from time to time. Such new versions will be similar in spirit to the present version, but may differ in detail to address new problems or concerns.

Each version is given a distinguishing version number. If the Program specifies a version number of this License which applies to it and "any later version", you have the option of following the terms and conditions either of that version or of any later version published by the Free Software Foundation. If the Program does not specify a version number of this License, you may choose any version ever published by the Free Software Foundation.

10. If you wish to incorporate parts of the Program into other free programs whose distribution conditions are different, write to the author to ask for permission. For software which is copyrighted by the Free Software Foundation, write to the Free Software Foundation; we sometimes make exceptions for this. Our decision will be guided by the two goals of preserving the free status of all derivatives of our free software and of promoting the sharing and reuse of software generally.

NO WARRANTY

11. BECAUSE THE PROGRAM IS LICENSED FREE OF CHARGE, THERE IS NO WARRANTY FOR THE PROGRAM, TO THE EXTENT PERMITTED BY APPLICABLE LAW. EXCEPT WHEN OTHERWISE STATED IN WRITING THE COPYRIGHT HOLDERS AND/OR OTHER PARTIES PROVIDE THE PROGRAM "AS IS" WITHOUT WARRANTY OF ANY KIND, EITHER EXPRESSED OR IMPLIED, INCLUDING, BUT NOT LIMITED TO, THE IMPLIED WARRANTIES OF MERCHANTABILITY AND FITNESS FOR A PARTICULAR PURPOSE. THE ENTIRE RISK AS TO THE QUALITY AND PERFORMANCE OF THE PROGRAM IS WITH YOU. SHOULD THE PROGRAM PROVE DEFECTIVE, YOU ASSUME THE COST OF ALL NECESSARY SERVICING, REPAIR OR CORRECTION.

12. IN NO EVENT UNLESS REQUIRED BY APPLICABLE LAW OR AGREED TO IN WRITING WILL ANY COPYRIGHT HOLDER, OR ANY OTHER PARTY WHO MAY MODIFY AND/OR REDISTRIBUTE THE PROGRAM AS PERMITTED ABOVE, BE LIABLE TO YOU FOR DAMAGES, INCLUDING ANY GENERAL, SPECIAL, INCIDENTAL OR CONSEQUENTIAL DAMAGES ARISING OUT OF THE USE OR INABILITY TO USE THE PROGRAM (INCLUDING BUT NOT LIMITED TO LOSS OF DATA OR DATA BEING RENDERED INACCURATE OR LOSSES SUSTAINED BY YOU OR THIRD PARTIES OR A FAILURE OF THE PROGRAM TO OPERATE WITH ANY OTHER PROGRAMS), EVEN IF SUCH HOLDER OR OTHER PARTY HAS BEEN ADVISED OF THE POSSIBILITY OF SUCH DAMAGES.

END OF TERMS AND CONDITIONS

How to Apply These Terms to Your New Programs

If you develop a new program, and you want it to be of the greatest possible use to the public, the best way to achieve this is to make it free software which everyone can redistribute and change under these terms.

To do so, attach the following notices to the program. It is safest to attach them to the start of each source file to most effectively convey the exclusion of warranty; and each file should have at least the "copyright" line and a pointer to where the full notice is found.

```
<one line to give the program's name and a brief idea of what it does.>
Copyright (C) <year> <name of author>
```

```
This program is free software; you can redistribute it and/or modify
it under the terms of the GNU General Public License as published by
the Free Software Foundation; either version 2 of the License, or
(at your option) any later version.
```

```
This program is distributed in the hope that it will be useful,
but WITHOUT ANY WARRANTY; without even the implied warranty of
MERCHANTABILITY or FITNESS FOR A PARTICULAR PURPOSE. See the
GNU General Public License for more details.
```

```
You should have received a copy of the GNU General Public License
along with this program; if not, write to the Free Software
Foundation, Inc., 59 Temple Place, Suite 330, Boston, MA 02111-1307 USA
```

Also add information on how to contact you by electronic and paper mail.

If the program is interactive, make it output a short notice like this when it starts in an interactive mode:

```
Gnomovision version 69, Copyright (C) year name of author
Gnomovision comes with ABSOLUTELY NO WARRANTY; for details type `show w'.
This is free software, and you are welcome to redistribute it
under certain conditions; type `show c' for details.
```

The hypothetical commands `show w' and `show c' should show the appropriate parts of the General Public License. Of course, the commands you use may be called something other than `show w' and `show c'; they could even be mouse-clicks or menu items--whatever suits your program.

You should also get your employer (if you work as a programmer) or your school, if any, to sign a "copyright disclaimer" for the program, if necessary. Here is a sample; alter the names:

```
Yoyodyne, Inc., hereby disclaims all copyright interest in the program
`Gnomovision' (which makes passes at compilers) written by James Hacker.
```

```
<signature of Ty Coon>, 1 April 1989
Ty Coon, President of Vice
```

This General Public License does not permit incorporating your program into

Open Source Software

proprietary programs. If your program is a subroutine library, you may consider it more useful to permit linking proprietary applications with the library. If this is what you want to do, use the GNU Library General Public License instead of this License.

<<net-snmp-5.7.2>>

---- Part 1: CMU/UCD copyright notice: (BSD like) ----

Copyright 1989, 1991, 1992 by Carnegie Mellon University

Derivative Work - 1996, 1998-2000

Copyright 1996, 1998-2000 The Regents of the University of California

All Rights Reserved

Permission to use, copy, modify and distribute this software and its documentation for any purpose and without fee is hereby granted, provided that the above copyright notice appears in all copies and that both that copyright notice and this permission notice appear in supporting documentation, and that the name of CMU and The Regents of the University of California not be used in advertising or publicity pertaining to distribution of the software without specific written permission.

CMU AND THE REGENTS OF THE UNIVERSITY OF CALIFORNIA DISCLAIM ALL WARRANTIES WITH REGARD TO THIS SOFTWARE, INCLUDING ALL IMPLIED WARRANTIES OF MERCHANTABILITY AND FITNESS. IN NO EVENT SHALL CMU OR THE REGENTS OF THE UNIVERSITY OF CALIFORNIA BE LIABLE FOR ANY SPECIAL, INDIRECT OR CONSEQUENTIAL DAMAGES OR ANY DAMAGES WHATSOEVER RESULTING FROM THE LOSS OF USE, DATA OR PROFITS, WHETHER IN AN ACTION OF CONTRACT, NEGLIGENCE OR OTHER TORTIOUS ACTION, ARISING OUT OF OR IN CONNECTION WITH THE USE OR PERFORMANCE OF THIS SOFTWARE.

---- Part 2: Networks Associates Technology, Inc copyright notice (BSD) ----

Copyright (c) 2001-2003, Networks Associates Technology, Inc
All rights reserved.

Redistribution and use in source and binary forms, with or without modification, are permitted provided that the following conditions are met:

- * Redistributions of source code must retain the above copyright notice, this list of conditions and the following disclaimer.
- * Redistributions in binary form must reproduce the above copyright notice, this list of conditions and the following disclaimer in the documentation and/or other materials provided with the distribution.
- * Neither the name of the Networks Associates Technology, Inc nor the names of its contributors may be used to endorse or promote products derived from this software without specific prior written permission.

THIS SOFTWARE IS PROVIDED BY THE COPYRIGHT HOLDERS AND CONTRIBUTORS "AS IS" AND ANY EXPRESS OR IMPLIED WARRANTIES, INCLUDING, BUT NOT LIMITED TO, THE IMPLIED WARRANTIES OF MERCHANTABILITY AND FITNESS FOR A PARTICULAR PURPOSE ARE DISCLAIMED. IN NO EVENT SHALL THE COPYRIGHT HOLDERS OR CONTRIBUTORS BE LIABLE FOR ANY DIRECT, INDIRECT, INCIDENTAL, SPECIAL, EXEMPLARY, OR CONSEQUENTIAL DAMAGES (INCLUDING, BUT NOT LIMITED TO, PROCUREMENT OF SUBSTITUTE GOODS OR SERVICES; LOSS OF USE, DATA, OR PROFITS; OR BUSINESS INTERRUPTION) HOWEVER CAUSED AND ON ANY THEORY OF LIABILITY, WHETHER IN CONTRACT, STRICT LIABILITY, OR TORT (INCLUDING NEGLIGENCE OR OTHERWISE) ARISING IN ANY WAY OUT OF THE USE OF THIS SOFTWARE, EVEN IF ADVISED OF THE POSSIBILITY OF SUCH DAMAGE.

---- Part 3: Cambridge Broadband Ltd. copyright notice (BSD) ----

Portions of this code are copyright (c) 2001-2003, Cambridge Broadband Ltd.
All rights reserved.

Redistribution and use in source and binary forms, with or without modification, are permitted provided that the following conditions are met:

- * Redistributions of source code must retain the above copyright notice, this list of conditions and the following disclaimer.
- * Redistributions in binary form must reproduce the above copyright notice, this list of conditions and the following disclaimer in the documentation and/or other materials provided with the distribution.
- * The name of Cambridge Broadband Ltd. may not be used to endorse or promote products derived from this software without specific prior written permission.

THIS SOFTWARE IS PROVIDED BY THE COPYRIGHT HOLDER ``AS IS" AND ANY EXPRESS OR IMPLIED WARRANTIES, INCLUDING, BUT NOT LIMITED TO, THE IMPLIED WARRANTIES OF MERCHANTABILITY AND FITNESS FOR A PARTICULAR PURPOSE ARE DISCLAIMED. IN NO EVENT SHALL THE COPYRIGHT HOLDER BE LIABLE FOR ANY DIRECT, INDIRECT, INCIDENTAL, SPECIAL, EXEMPLARY, OR CONSEQUENTIAL DAMAGES (INCLUDING, BUT NOT LIMITED TO, PROCUREMENT OF SUBSTITUTE GOODS OR SERVICES; LOSS OF USE, DATA, OR PROFITS; OR BUSINESS INTERRUPTION) HOWEVER CAUSED AND ON ANY THEORY OF LIABILITY, WHETHER IN CONTRACT, STRICT LIABILITY, OR TORT (INCLUDING NEGLIGENCE OR OTHERWISE) ARISING IN ANY WAY OUT OF THE USE OF THIS SOFTWARE, EVEN IF ADVISED OF THE POSSIBILITY OF SUCH DAMAGE.

---- Part 4: Sun Microsystems, Inc. copyright notice (BSD) ----

Copyright © 2003 Sun Microsystems, Inc., 4150 Network Circle, Santa Clara, California 95054, U.S.A. All rights reserved.

Use is subject to license terms below.

This distribution may include materials developed by third parties.

Sun, Sun Microsystems, the Sun logo and Solaris are trademarks or registered trademarks of Sun Microsystems, Inc. in the U.S. and other countries.

Redistribution and use in source and binary forms, with or without modification, are permitted provided that the following conditions are met:

- * Redistributions of source code must retain the above copyright notice, this list of conditions and the following disclaimer.
- * Redistributions in binary form must reproduce the above copyright notice, this list of conditions and the following disclaimer in the documentation and/or other materials provided with the distribution.
- * Neither the name of the Sun Microsystems, Inc. nor the names of its contributors may be used to endorse or promote products derived from this software without specific prior written permission.

THIS SOFTWARE IS PROVIDED BY THE COPYRIGHT HOLDERS AND CONTRIBUTORS ``AS IS" AND ANY EXPRESS OR IMPLIED WARRANTIES, INCLUDING, BUT NOT LIMITED TO, THE IMPLIED WARRANTIES OF MERCHANTABILITY AND FITNESS FOR A PARTICULAR PURPOSE ARE DISCLAIMED. IN NO EVENT SHALL THE COPYRIGHT HOLDERS OR CONTRIBUTORS BE LIABLE FOR ANY DIRECT, INDIRECT, INCIDENTAL, SPECIAL, EXEMPLARY, OR CONSEQUENTIAL DAMAGES (INCLUDING, BUT NOT LIMITED TO, PROCUREMENT OF SUBSTITUTE GOODS OR SERVICES; LOSS OF USE, DATA, OR PROFITS; OR BUSINESS INTERRUPTION) HOWEVER CAUSED AND ON ANY THEORY OF LIABILITY,

WHETHER IN CONTRACT, STRICT LIABILITY, OR TORT (INCLUDING NEGLIGENCE OR OTHERWISE) ARISING IN ANY WAY OUT OF THE USE OF THIS SOFTWARE, EVEN IF ADVISED OF THE POSSIBILITY OF SUCH DAMAGE.

---- Part 5: Sparta, Inc copyright notice (BSD) ----

Copyright (c) 2003-2009, Sparta, Inc
All rights reserved.

Redistribution and use in source and binary forms, with or without modification, are permitted provided that the following conditions are met:

- * Redistributions of source code must retain the above copyright notice, this list of conditions and the following disclaimer.
- * Redistributions in binary form must reproduce the above copyright notice, this list of conditions and the following disclaimer in the documentation and/or other materials provided with the distribution.
- * Neither the name of Sparta, Inc nor the names of its contributors may be used to endorse or promote products derived from this software without specific prior written permission.

THIS SOFTWARE IS PROVIDED BY THE COPYRIGHT HOLDERS AND CONTRIBUTORS ``AS IS'' AND ANY EXPRESS OR IMPLIED WARRANTIES, INCLUDING, BUT NOT LIMITED TO, THE IMPLIED WARRANTIES OF MERCHANTABILITY AND FITNESS FOR A PARTICULAR PURPOSE ARE DISCLAIMED. IN NO EVENT SHALL THE COPYRIGHT HOLDERS OR CONTRIBUTORS BE LIABLE FOR ANY DIRECT, INDIRECT, INCIDENTAL, SPECIAL, EXEMPLARY, OR CONSEQUENTIAL DAMAGES (INCLUDING, BUT NOT LIMITED TO, PROCUREMENT OF SUBSTITUTE GOODS OR SERVICES; LOSS OF USE, DATA, OR PROFITS; OR BUSINESS INTERRUPTION) HOWEVER CAUSED AND ON ANY THEORY OF LIABILITY, WHETHER IN CONTRACT, STRICT LIABILITY, OR TORT (INCLUDING NEGLIGENCE OR OTHERWISE) ARISING IN ANY WAY OUT OF THE USE OF THIS SOFTWARE, EVEN IF ADVISED OF THE POSSIBILITY OF SUCH DAMAGE.

---- Part 6: Cisco/BUPTNIC copyright notice (BSD) ----

Copyright (c) 2004, Cisco, Inc and Information Network
Center of Beijing University of Posts and Telecommunications.
All rights reserved.

Redistribution and use in source and binary forms, with or without modification, are permitted provided that the following conditions are met:

- * Redistributions of source code must retain the above copyright notice, this list of conditions and the following disclaimer.
- * Redistributions in binary form must reproduce the above copyright notice, this list of conditions and the following disclaimer in the documentation and/or other materials provided with the distribution.
- * Neither the name of Cisco, Inc, Beijing University of Posts and Telecommunications, nor the names of their contributors may be used to endorse or promote products derived from this software without specific prior written permission.

THIS SOFTWARE IS PROVIDED BY THE COPYRIGHT HOLDERS AND CONTRIBUTORS ``AS IS'' AND ANY EXPRESS OR IMPLIED WARRANTIES, INCLUDING, BUT NOT LIMITED TO, THE IMPLIED WARRANTIES OF MERCHANTABILITY AND FITNESS FOR A PARTICULAR PURPOSE ARE DISCLAIMED. IN NO EVENT SHALL THE COPYRIGHT HOLDERS OR CONTRIBUTORS BE LIABLE FOR ANY DIRECT, INDIRECT, INCIDENTAL, SPECIAL, EXEMPLARY, OR CONSEQUENTIAL DAMAGES (INCLUDING, BUT NOT LIMITED TO, PROCUREMENT OF SUBSTITUTE GOODS OR SERVICES; LOSS OF USE, DATA, OR PROFITS; OR BUSINESS INTERRUPTION) HOWEVER CAUSED AND ON ANY THEORY OF LIABILITY, WHETHER IN CONTRACT, STRICT LIABILITY, OR TORT (INCLUDING NEGLIGENCE OR OTHERWISE) ARISING IN ANY WAY OUT OF THE USE OF THIS SOFTWARE, EVEN IF ADVISED OF THE POSSIBILITY OF SUCH DAMAGE.

---- Part 7: Fabasoft R&D Software GmbH & Co KG copyright notice (BSD) ----

Copyright (c) Fabasoft R&D Software GmbH & Co KG, 2003
oss@fabasoft.com
Author: Bernhard Penz

Redistribution and use in source and binary forms, with or without modification, are permitted provided that the following conditions are met:

- * Redistributions of source code must retain the above copyright notice, this list of conditions and the following disclaimer.
- * Redistributions in binary form must reproduce the above copyright notice, this list of conditions and the following disclaimer in the documentation and/or other materials provided with the distribution.
- * The name of Fabasoft R&D Software GmbH & Co KG or any of its subsidiaries, brand or product names may not be used to endorse or promote products derived from this software without specific prior written permission.

THIS SOFTWARE IS PROVIDED BY THE COPYRIGHT HOLDER "AS IS" AND ANY EXPRESS OR IMPLIED WARRANTIES, INCLUDING, BUT NOT LIMITED TO, THE IMPLIED WARRANTIES OF MERCHANTABILITY AND FITNESS FOR A PARTICULAR PURPOSE ARE DISCLAIMED. IN NO EVENT SHALL THE COPYRIGHT HOLDER BE LIABLE FOR ANY DIRECT, INDIRECT, INCIDENTAL, SPECIAL, EXEMPLARY, OR CONSEQUENTIAL DAMAGES (INCLUDING, BUT NOT LIMITED TO, PROCUREMENT OF SUBSTITUTE GOODS OR SERVICES; LOSS OF USE, DATA, OR PROFITS; OR BUSINESS INTERRUPTION) HOWEVER CAUSED AND ON ANY THEORY OF LIABILITY, WHETHER IN CONTRACT, STRICT LIABILITY, OR TORT (INCLUDING NEGLIGENCE OR OTHERWISE) ARISING IN ANY WAY OUT OF THE USE OF THIS SOFTWARE, EVEN IF ADVISED OF THE POSSIBILITY OF SUCH DAMAGE.

---- Part 8: Apple Inc. copyright notice (BSD) ----

Copyright (c) 2007 Apple Inc. All rights reserved.

Redistribution and use in source and binary forms, with or without modification, are permitted provided that the following conditions are met:

1. Redistributions of source code must retain the above copyright notice, this list of conditions and the following disclaimer.
2. Redistributions in binary form must reproduce the above copyright notice, this list of conditions and the following disclaimer in the documentation and/or other materials provided with the distribution.
3. Neither the name of Apple Inc. ("Apple") nor the names of its contributors may be used to endorse or promote products derived from this software without specific prior written permission.

THIS SOFTWARE IS PROVIDED BY APPLE AND ITS CONTRIBUTORS "AS IS" AND ANY EXPRESS OR IMPLIED WARRANTIES, INCLUDING, BUT NOT LIMITED TO, THE IMPLIED WARRANTIES OF MERCHANTABILITY AND FITNESS FOR A PARTICULAR PURPOSE ARE DISCLAIMED. IN NO EVENT SHALL APPLE OR ITS CONTRIBUTORS BE LIABLE FOR ANY DIRECT, INDIRECT, INCIDENTAL, SPECIAL, EXEMPLARY, OR CONSEQUENTIAL DAMAGES (INCLUDING, BUT NOT LIMITED TO, PROCUREMENT OF SUBSTITUTE GOODS OR SERVICES; LOSS OF USE, DATA, OR PROFITS; OR BUSINESS INTERRUPTION) HOWEVER CAUSED AND ON ANY THEORY OF LIABILITY, WHETHER IN CONTRACT, STRICT LIABILITY, OR TORT (INCLUDING NEGLIGENCE OR OTHERWISE) ARISING IN ANY WAY OUT OF THE USE OF THIS SOFTWARE, EVEN IF ADVISED OF THE POSSIBILITY OF SUCH DAMAGE.

---- Part 9: ScienceLogic, LLC copyright notice (BSD) ----

Copyright (c) 2009, ScienceLogic, LLC
All rights reserved.

Open Source Software

Redistribution and use in source and binary forms, with or without modification, are permitted provided that the following conditions are met:

- * Redistributions of source code must retain the above copyright notice, this list of conditions and the following disclaimer.
- * Redistributions in binary form must reproduce the above copyright notice, this list of conditions and the following disclaimer in the documentation and/or other materials provided with the distribution.
- * Neither the name of ScienceLogic, LLC nor the names of its contributors may be used to endorse or promote products derived from this software without specific prior written permission.

THIS SOFTWARE IS PROVIDED BY THE COPYRIGHT HOLDERS AND CONTRIBUTORS "AS IS" AND ANY EXPRESS OR IMPLIED WARRANTIES, INCLUDING, BUT NOT LIMITED TO, THE IMPLIED WARRANTIES OF MERCHANTABILITY AND FITNESS FOR A PARTICULAR PURPOSE ARE DISCLAIMED. IN NO EVENT SHALL THE COPYRIGHT HOLDERS OR CONTRIBUTORS BE LIABLE FOR ANY DIRECT, INDIRECT, INCIDENTAL, SPECIAL, EXEMPLARY, OR CONSEQUENTIAL DAMAGES (INCLUDING, BUT NOT LIMITED TO, PROCUREMENT OF SUBSTITUTE GOODS OR SERVICES; LOSS OF USE, DATA, OR PROFITS; OR BUSINESS INTERRUPTION) HOWEVER CAUSED AND ON ANY THEORY OF LIABILITY, WHETHER IN CONTRACT, STRICT LIABILITY, OR TORT (INCLUDING NEGLIGENCE OR OTHERWISE) ARISING IN ANY WAY OUT OF THE USE OF THIS SOFTWARE, EVEN IF ADVISED OF THE POSSIBILITY OF SUCH DAMAGE.

Appendix

Specifications

Item	Specifications
LCD Display	Color, QVGA
LCD Size	3.5 inch
LCD Brightness	14 levels
Flexible Buttons	24 (Three pages of eight flexible buttons are shown on the display)
VoIP Connection Method	SIP
VoIP Audio Codec	G.711A, G.711U, G.729AB, G.722, G.726
Ethernet Interface	10Base-T/100Base-TX/1000Base-T
IP Address Mode	Dual stack, IPv4 only, IPv6 only
Speaker	1
Microphone	1
Ethernet Port (LAN)	2 (RJ45)
Headset Jack	1 (RJ9)
EHS Jack	1 (RJ11)
Dimensions (Width × Depth × Height; handset on cradle, stand attached)	"High" position: 267 mm × 170 mm × 180 mm (10.5 in × 6.69 in × 7.09 in) "Low" position: 267 mm × 187 mm × 155 mm (10.5 in × 7.36 in × 6.10 in)
Weight (with handset, handset cord and stand)	1130 g (2.49 lb)
PoE	IEEE 802.3af Class 2 standard compliant
Power Consumption	PoE Stand-by: approx. 2.61 W Talking: approx. 3.44 W AC Adaptor Stand-by: approx. 2.64 W Talking: approx. 3.42 W
Maximum Power Consumption	4.46 W
Operating Environment	0 °C to 40 °C (32 °F to 104 °F)

Troubleshooting

Common Issues and Solutions

General Use

Issue	Possible Cause & Solution	Reference
The display is blank.	<ul style="list-style-type: none"> The unit is not receiving power. <ul style="list-style-type: none"> → The unit is not designed to function when there is a power failure. Make sure that the device supplying PoE is receiving power and that the Ethernet cable is properly connected. If an AC adaptor is connected, confirm that the AC adaptor is connected and receiving power. 	Page 56
The display is not shown well.	<ul style="list-style-type: none"> The display's brightness is too low. <ul style="list-style-type: none"> → Adjust the display's brightness. 	Page 41
The unit is not performing properly.	<ul style="list-style-type: none"> Cables or cords are not connected properly. <ul style="list-style-type: none"> → Check all connections. 	Page 56
	<ul style="list-style-type: none"> Your connection settings are incorrect. <ul style="list-style-type: none"> → Consult your administrator to confirm that your settings are correct. → If the problem persists, consult your dealer. 	Page 37
	<ul style="list-style-type: none"> An error has occurred. <ul style="list-style-type: none"> → Restart the unit. 	Page 64
 is displayed on the screen.	<ul style="list-style-type: none"> Registration to the SIP server has been lost. <ul style="list-style-type: none"> → Consult your administrator or dealer. 	—
I cannot hear a dial tone.	<ul style="list-style-type: none"> Confirm that the LAN cable is properly connected. 	Page 56
I cannot cancel the display lock.	<ul style="list-style-type: none"> The PIN number you entered was incorrect. <ul style="list-style-type: none"> → Consult your administrator or dealer. 	—
I forgot my PIN number.	<ul style="list-style-type: none"> Consult your administrator or dealer. 	—
The date and time are not correct.	<ul style="list-style-type: none"> Adjust the date and time of the unit. 	Page 40
The Message/Ringer lamp is lit.	<ul style="list-style-type: none"> You received a voice message while you were on the phone or away from your desk. <ul style="list-style-type: none"> → Check the voice message. 	Page 26

Making and Receiving Calls

Issue	Possible Cause & Solution	Reference
I cannot make calls.	<ul style="list-style-type: none"> Your phone system/service has disabled service for your unit. → On the Information Display screen (Page 38), if "Not registered" is displayed for the lines registered to your phone, consult your administrator or dealer. 	—
	<ul style="list-style-type: none"> The phone number was entered incorrectly. → Confirm that you have entered the phone number of the other party correctly. → Consult your administrator or dealer. 	Page 20
	<ul style="list-style-type: none"> The unit is downloading a firmware update. → You cannot make calls while the unit is downloading updates. Wait for the update to finish, and then try making a call. 	—
	<ul style="list-style-type: none"> The phonebook list is being imported or exported. → Wait a few minutes for the operation to complete. → Confirm with your administrator or dealer. 	—
I cannot make long distance calls.	<ul style="list-style-type: none"> Your telephone service does not allow you to make long distance calls. → Make sure that you have subscribed to your telephone company's long distance service. 	—
The unit does not ring when a call is received.	<ul style="list-style-type: none"> The ringer volume is turned off. → Press [+] on the VOLUME key. 	Page 19
While talking to an outside party, the line is disconnected.	<ul style="list-style-type: none"> Your phone system/service may impose a time limit on outside calls. → Consult your dealer to extend the time limit, if necessary. 	—

Sound Quality

Issue	Possible Cause & Solution	Reference
The other party cannot hear my voice.	<ul style="list-style-type: none"> The unit is muted. → Press [MUTE] to turn off the mute feature. 	Page 25
	<ul style="list-style-type: none"> If you are using the speakerphone, objects may be obstructing the microphone. → Do not obstruct the unit's microphone during calls. Keep your hands, as well as common objects such as folders, cups, and coffee pots away from the unit during calls. 	—

Issue	Possible Cause & Solution	Reference
Sound cuts out; I can hear myself through the speaker.	<ul style="list-style-type: none"> You are too far away from the microphone. → Try speaking closer to the microphone. 	—
	<ul style="list-style-type: none"> The environment is not suited to speakerphone calls. → Do not use the unit within 2 m (6.6 ft) of projectors, air conditioning devices, fans, or other audible or electrical noise emitting devices. → If using the unit in a room with windows, close the curtains or blinds to prevent echoes. → Use the unit in a quiet environment. 	—
	<ul style="list-style-type: none"> The unit was moved during a call. → Do not move the unit while on a call. 	—
	<ul style="list-style-type: none"> Objects are obstructing the microphone. → Do not obstruct the unit during calls. Keep your hands, as well as common objects such as folders, cups, and coffee pots away from the unit during calls. 	—
	<ul style="list-style-type: none"> The other party is using a half-duplex speakerphone. → If the other party is using a half-duplex speakerphone, sound may cut out occasionally during calls. For best performance, the other party should use a full-duplex speakerphone. 	—
	<ul style="list-style-type: none"> Just after a call begins, the unit may not have yet adjusted itself to the call's environment. → Just after a call begins, take turns with the other party talking to each other. The unit will adjust itself in accordance with the call environment so that both you and the other party can hear each other as clearly as possible. 	—

Phonebook List

Issue	Possible Cause & Solution	Reference
I cannot add or edit entries to the phonebook list.	<ul style="list-style-type: none"> The phonebook list is full. → Delete any unnecessary entries. The maximum number of entries in the phonebook list is 1,000. 	Page 34

Error Messages

During operation, error messages might appear on the unit. The following table lists these messages and possible causes and solutions.

Message	Possible Cause & Solution	Reference
IP Address, Subnet Mask and Default Gateway are not matched.	<ul style="list-style-type: none"> The unit's network settings are incorrect. → Consult your system administrator or dealer. 	—
Default Gateway is not matched with the IP Address and Subnet Mask		
IP Address: Invalid Value		
Maximum save count limit reached.	<ul style="list-style-type: none"> A new entry for the phonebook or call block list cannot be stored because the phonebook or call block list is full. → Erase unneeded entries. 	Page 35

Index

Numerics

802.1x (setting) 46

A

AC adaptor 9
 Connection 56
 Accessories 9
 Application Server (setting) 48
 Application Settings 48
 Authentication ID (setting) 47
 Authentication Password (setting) 47
 Authentication Protocol (setting) 47
 Auto answer 22

B

BLF flexible button 29
 Block Anonymous Call (setting) 44
 Brightness (setting) 41
 Busy Lamp Field → BLF 29

C

Call Block (setting) 42
 Call buttons 14
 Call Forwarding 27
 Call Icons 16
 Call Log Icons 16
 Call Rejection Phone Numbers List (setting) 42
 Call Splitting 24
 Call Transfer 25
 Call Waiting 24
 Calls
 From call logs 20
 From phonebook list 20
 Holding 23
 Making 20
 Missed 27
 Receiving 22
 Redialing 20
 Rejecting 22
 CDP Interval timer (setting) 46
 CDP Settings (setting) 46
 Character entry 50
 Cleaning 65
 CONFERENCE button 11
 Conference call 26
 Connections 56
 Controls 10
 Bottom view 12
 Front View 10
 Left view 12

D

Date (setting) 40
 Date and Time (setting) 40
 Date Template (setting) 40
 DC jack 12

Delay Time (0-10) (setting) 41
 DHCP Options (setting) 48
 Dialing 20
 Display 10
 Display Lock (setting) 42
 Do Not Disturb 27

E

ECO Mode (setting) 43
 EHS headsets 56
 EHS jack 12
 Electronic Hook Switch → EHS 56
 Embedded Web (setting) 47
 Enable 802.1x (setting) 46
 Enable Application (setting) 48
 Enable CDP (setting) 46
 Enable Hotline (setting) 41
 Enable IP Phone VLAN (setting) 46
 Enable LLDP (setting) 46
 Enable PC VLAN (setting) 46
 Enable SIP PnP (setting) 48
 ENTER key 11
 Enterprise Phonebook 35
 Erasing All Call Logs 27
 Error messages 85
 Ethernet cable 9
 Exclude Network Settings (setting) 49
 Exclude Private Settings (setting) 49
 Extension number 19

F

Flexible Button Icons 29
 Flexible Button Transfer 25
 Flexible buttons 29
 Flexible Buttons 10
 FORWARD/DO NOT DISTURB button 10
 Forwarding 27
 FWD/DND (setting) 43
 FWD/DND Setting 43

H

Handset 9
 Connections 58
 Hooking 62
 Volume 19
 Handset cord 9
 Handset Hook 10
 Handset jack 12
 Hands-free mode 19
 Headset 56
 Using 64
 Volume 19
 HEADSET button 11
 Headset jack 12
 Hold 23
 HOLD button 11
 HOME 11
 Home screen 13
 Home screen icons
 Icons 13
 Hotline (setting) 41

HTTP Authentication (setting) 48

I

Icons 15
 Ignoring Calls 23
 IM&P
 Calling Contacts 33
 Contacts 32
 Logging in to IM&P 31
 Making Conference Calls 33
 Presence 32
 Sending Messages 33
 IM&P (Instant Messaging & Presence) 31
 Information Display 44
 Information Display (setting) 44
 Installation 53
 Intercom 21
 IP Address Mode (setting) 45
 IP Phone VLAN ID (setting) 46
 IPv4 (setting) 45
 IPv6 (setting) 45

K

Key Click Tone (setting) 42

L

LAN connection 56
 LAN port 12
 LAN Port (setting) 47
 Language (setting) 41
 Last Number Redial 20
 LCD (Liquid Crystal Display) 10
 LDAP Phonebook 35
 Line Buttons 14
 Line Icons 15
 LLDP Settings (setting) 46
 LLDP-MED Interval timer (setting) 46
 Local Phonebook 35

M

Maintenance 64
 Making calls 20
 Calling 20
 MESSAGE button 10
 Message/Ringer Lamp 10
 Messages, checking 26
 Missed calls 27
 Multicast Paging 21
 Multicast Paging (setting) 48
 Multicast Paging Icons 21
 Mute 25
 MUTE button 11

N

Navigator Key 10
 Network (setting) 45
 Network Test 49
 Network Test (setting) 49

O

One-touch Dialing 21
 One-Touch flexible button 29
 Optional Group Features 28

P

Page buttons 14
 Paging DND (setting) 48
 Password (setting) 48
 PC connection 56
 PC port 12
 PC Port (setting) 47
 PC VLAN ID (setting) 46
 Phone Number (setting) 41
 Phone screen 14
 Phonebook list
 Adding 34
 Deleting 35
 Editing 34
 Export 35
 Import 35
 Searching 20, 35
 Port Mirroring (setting) 47
 Programming, web user interface 52
 Provision Server (setting) 48
 Provisioning (setting) 48
 Push To Talk 21

R

Receiving calls 22
 Redial 20
 REDIAL button 11
 Rejecting calls 22
 Reset 49, 64
 Restart 49, 64
 Restart (setting) 49
 Ringer
 Volume setting 19
 Ringer/Message Lamp 10
 Ringtone (setting) 41

S

SCA 28
 Search, phonebook list 20
 Service URL (setting) 48
 Services 28
 Settings 37
 Accessing 37
 Setup 53
 Initial settings 64
 Shared Call Appearance 28
 Soft buttons 17
 Icons 15, 17
 Soft Buttons 10
 Speaker
 Volume 19
 Speakerphone (SP-PHONE) button 11
 Specifications 81
 Speed/Duplex (setting) 47
 SP-PHONE (Speakerphone) button 11

Index

Stand 9
 Adjusting 54
 Attaching 53
 Removing 53
Status bar 13
Status Icons 15

T

Time (setting) 40
Transfer 25
TRANSFER button 11
Troubleshooting 82

U

Use 12-hour Format (setting) 40
User ID (setting) 48, 49
User Password (setting) 49
User settings 37

V

VLAN Settings (setting) 46
Volume 19
VOLUME button 10

W

Wall mount kit 9
Wall mounting 59
Web user interface programming 52

WALL MOUNTING TEMPLATE

1. Drive the screws into the wall as indicated.
2. Hook the unit onto the screw heads.

Note:

Make sure to set the print size to correspond with the size of this page. If the dimensions of the paper output still deviate slightly from the measurements indicated here, use the measurements indicated here.

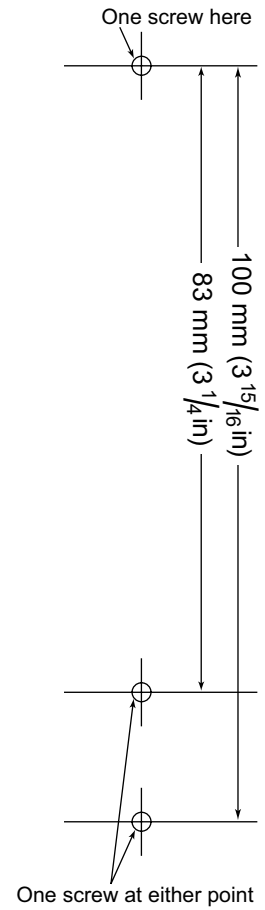

Notes

Panasonic Corporation of North America

Two Riverfront Plaza, Newark, NJ 07102-5490

<http://www.panasonic.com/sip>

Copyright:

This material is copyrighted by Panasonic System Communications Company of North America, and may be reproduced for internal use only. All other reproduction, in whole or in part, is prohibited without the written consent of Panasonic System Communications Company of North America.

© Panasonic System Communications Company of North America 2014

PNQX6601ZA CC0414MJ0