

Panasonic®

Operating Instructions

Smart Desk Phone

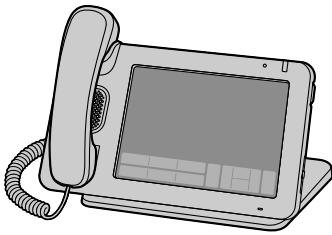

Model No. **KX-UT670**



Thank you for purchasing this Panasonic product.
Please read this manual carefully before using this product and save this manual for future use.

KX-UT670: Software File Version 01.030 or later

In this manual, the suffix of each model number is omitted unless necessary.

Document Version: 2012-02

Introduction

Feature Highlights

7-inch Color Touch Display

You can directly interact with the unit in a way only possible with a touch display: Swipe your finger to scroll through your contacts to find the desired party, or tap an entry in the call log to call that person back.

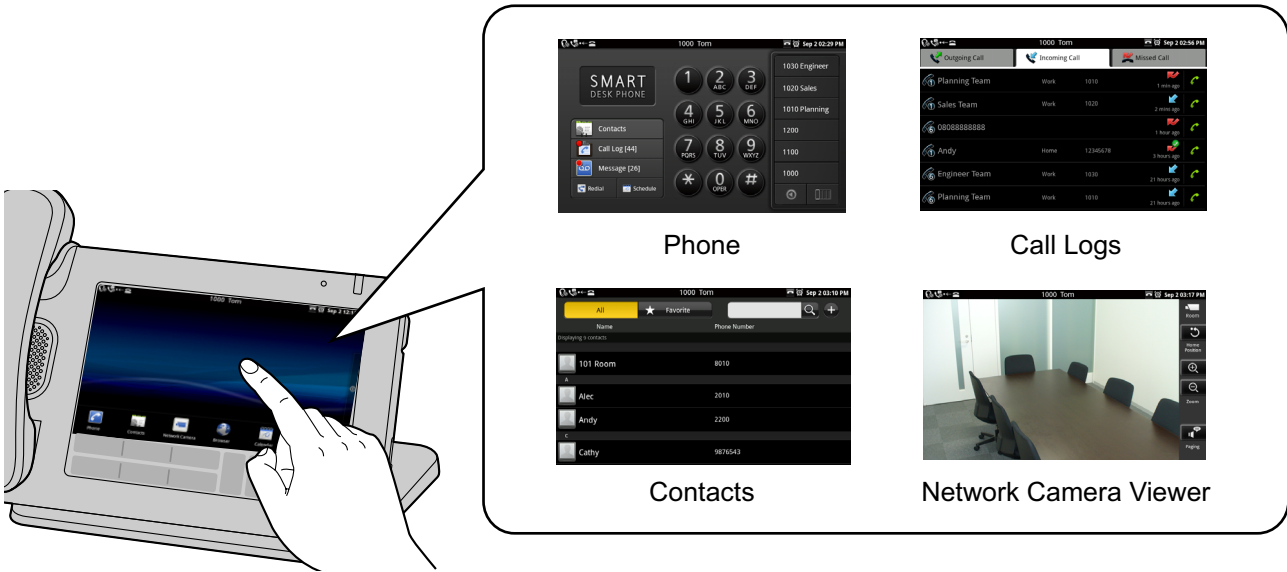

Support for High-quality Audio

The wide-band (7 kHz) audio provides high voice quality in conversations.

Applications on Your Phone

You can use a variety of applications, such as a web browser, calendar, e-mail, photo gallery, music, and more (Page 71).

Synchronization with Your Google™ Account

By registering your Google account, your contacts and calendar will be synchronized between this unit and your Google account (Page 128).

Network Camera Integration

Registering network cameras allows you to use the phone to view those cameras' video feeds (Page 43). If a network camera is associated with a phone number (paging number), you can call that number while viewing the camera's video feed (Page 66).

Also, if a network camera's information is registered to a contact, when you begin a conversation with that contact, Network Camera Viewer starts automatically and you can view the camera's video feed during the conversation (Page 58).

For the most recent information about network cameras that have been tested with this unit, refer to the following web site:

<http://www.panasonic.com/sip> (for users in the United States)

<http://panasonic.net/pcc/support/sipphone> (for users in Canada)



Compatible with Electric Hook Switch (EHS) Headsets

You can connect an EHS headset and use it to talk to other parties (Page 106).

Other Information

Documentation for This Unit

The documentation for this unit consists of the following three manuals:

Getting Started

Briefly describes basic information about the installation of the unit.

Operating Instructions (this manual)

Describes the parts of the unit, operation procedures, maintenance, etc.

Administrator Guide

Describes information about programming the unit.

Manuals and supporting information are provided on the Panasonic web site at:

<http://www.panasonic.com/sip> (for users in the United States)

<http://panasonic.net/pcc/support/sipphone> (for users in Canada)

Note

- The contents and design of the software are subject to change without notice.

Conventions Used in This Manual

- SD memory cards that can be used with this unit are collectively referred to as "SD cards" (Page 126).
- Buttons on the key sheet (Page 19) are shown as  Menu. Other text that appears on the screen is enclosed in square brackets and is shown in a bold typeface: **[Text]**.

Trademarks

- SDXC logo is a trademark of SD-3C, LLC.
- Google is a trademark of Google Inc.
- vCard is a trademark of Internet Mail Consortium.
- Plantronics is a trademark or registered trademark of Plantronics, Inc.
- All other trademarks identified herein are the property of their respective owners.

Copyright Notices

- The preset melodies in this product are used with permission of © 2009 Copyrights Vision Inc.
- iWnn IME © OMRON SOFTWARE Co., Ltd. 2010 All Rights Reserved.
- Parts of this product use Open Source Software supplied based on the conditions of the Free Software Foundation's GPLs and/or LGPLs and other conditions. Relevant conditions apply to this software. Therefore, please read license information about GPLs and LGPLs, and information about other Open Source Software available from this product.

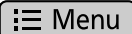
To view this information, press  when the Home screen is displayed, and then tap **[Settings]** → **[About phone]** → **[Legal information]**.

At least three (3) years from delivery of products, Panasonic System Networks Co., Ltd. will give to any third party who contacts us at the contact information provided below, for a charge of no more than the cost of physically distributing source code, a complete machine-readable copy of the corresponding source code and the copyright notices covered under GPL and LGPL. Please note that software licensed under GPL and LGPL is not under warranty.

http://www.panasonic.net/corporate/global_network/

- Do not attach copyright-protected files, such as graphics or music files, to e-mail messages if you do not hold the copyrights to those files. With the exception of duplicating or quoting for personal use as permitted by law, you may not duplicate, alter, publicly transmit, repurpose, or distribute such works without the consent of the copyright holder.

When you ship the product (For users in the United States only)

Carefully pack and send it prepaid, adequately insured and preferably in the original carton. Attach a postage-paid letter, detailing the symptom to the outside of the carton.

DO NOT send the product to the Executive or Regional Sales offices. They are NOT equipped to make repairs.

Product Service (For users in the United States only)

Panasonic factory service centers for this product are listed in the service center directory. Consult your authorized Panasonic dealer for detailed instructions.

For Future Reference

Record the information in the space below for future reference.

Note

- The serial number and MAC address of this product may be found on the label affixed to the bottom of the unit. You should note the serial number and MAC address of this unit in the space provided and retain this manual as a permanent record of your purchase to aid in identification in the event of theft.

MODEL NO.	_____
SERIAL NO.	_____
MAC ADDRESS	_____
DATE OF PURCHASE	_____
NAME OF DEALER	_____
DEALER'S ADDRESS	_____



DEALER'S TEL. NO.	_____

For Your Safety



To reduce the risk of injury, loss of life, electric shock, fire, malfunction, and damage to equipment or property, always observe the following safety precautions.

Explanation of symbols

The following symbols are used to classify and describe the level of hazard and injury caused when the denotation is disregarded and improper use is performed.

 <h2 style="margin: 0;">WARNING</h2> <p>Denotes a potential hazard that could result in serious injury or death.</p>
 <h2 style="margin: 0;">CAUTION</h2> <p>Denotes a hazard that could result in minor injury or damage to the unit or other equipment.</p>









The following symbols are used to classify and describe the type of instructions to be observed.

	<p>This symbol is used to alert users to a specific operating procedure that must not be performed.</p>
	<p>This symbol is used to alert users to a specific operating procedure that must be followed in order to operate the unit safely.</p>



WARNING

General Safety

-  Do not disassemble this unit. Dangerous electrical shock could result. The unit must only be disassembled and repaired by qualified service technicians.
-  Never attempt to insert wires, pins, etc. into the vents or other holes of this unit.
-  To prevent possible fire or electric shock, do not expose this unit to rain or moisture.
-  Do not splash water on the AC adaptor or the power cord, nor get them wet. Doing so can result in fire, electric shock, or injury. If they do get wet, immediately disconnect the AC adaptor and power cord, and contact an authorized service center.
-  Do not touch the AC adaptor for extended periods of time. Doing so can lead to low-degree burns.
-  Do not use the power cord with other products. Doing so can result in fire or electric shock.
-  Unplug this unit from the AC outlet and have the unit serviced by qualified service personnel in the following cases:
 - A.** When the power supply cord or plug is damaged or frayed.
 - B.** If liquid has been spilled on the unit.
 - C.** If the unit has been exposed to rain or water.
 - D.** If the unit does not work normally by following the manual. Adjust only controls covered by the manual. Improper adjustment may require repair by an authorized service center.
 - E.** If the unit has been dropped, or damaged.
 - F.** If the unit's performance deteriorates.
-  If damage to the unit exposes any internal parts, immediately disconnect the cable or cord. If the power is supplied from the network to the Smart Desk Phone [Power-over-Ethernet], disconnect the Ethernet cables. Otherwise, disconnect the AC adaptor cord. Then return this unit to an authorized service center.

- ⚠ This handset earpiece is magnetized and may retain small ferrous objects.
- ⚠ The use of excessive sound volume through earphones, headphones, or headsets may cause hearing loss.
- ⚠ Disconnect this unit from power outlet/the Ethernet cables if it emits smoke, an abnormal smell, or makes unusual noise. These conditions can cause fire or electric shock. Confirm that smoke has stopped and contact an authorized service center.

Installation

- ⊘ Do not make power connections that exceed the ratings for the AC outlet or power equipment. If the power rating of a surge protector, etc. is exceeded, it can cause a fire due to heat buildup.
- ⊘ Do not bundle up the AC adaptor cord. The cord may become damaged, which can lead to a fire, electric shock, or electric short.
- ⚠ The unit should only be connected to a power supply of the type as shown on the label on the unit.
- ⚠ Completely insert the AC adaptor into the AC outlet. Failure to do so may cause electric shock and/or excessive heat resulting in a fire.

Placement

- ⊘ Care should be taken so that objects do not fall onto, and liquids are not spilled into, the unit. Do not subject this unit to excessive smoke, dust, moisture, mechanical vibration, shock, or direct sunlight.
- ⊘ Do not place heavy objects on top of this unit.
- ⚠ Place this unit on a flat surface.
- ⚠ Allow 10 cm (3 ¹⁵/₁₆ in) clearance around the unit for proper ventilation.

Wall Mounting

- ⊘ Do not mount the unit in a manner other than that described in this manual.
- ⚠ Make sure that the wall that the unit will be attached to is strong enough to support the unit (approx. 1.3 kg [2.9 lb]). If not, it is necessary for the wall to be reinforced.

- ⚠ Only use the optional wall mount kit with the unit. The wall mount kit includes the necessary screws, washers, and wall mounting adaptor.
- ⚠ When driving the screws into the wall, be careful to avoid touching any metal laths, wire laths or metal plates in the wall.
- ⚠ When this unit is no longer in use, make sure to detach it from the wall.



CAUTION

- ⊘ Keep the unit away from heating appliances and devices that generate electrical noise, such as fluorescent lamps, motors and televisions. These noise sources can interfere with the performance of the unit. It also should not be placed in rooms where the temperature is less than 0 °C (32 °F) or greater than 40 °C (104 °F).
- ⚠ Wipe the unit with a soft cloth. Do not clean the unit with abrasive powders or with chemical agents such as benzine or thinner.
- ⚠ The SD card, the SD card slot cover, and the handset hook pose a choking hazard. Keep the SD card, the SD card slot cover, and the handset hook out of reach of children.
- ⚠ When left unused for a long period of time, disconnect the unit from the AC outlet. When the unit receives power from a PoE power supply, disconnect the Ethernet cables.
- ⚠ When the unit is mounted on a wall, make sure the cables are securely fastened to the wall.

Notice

- If the unit does not operate properly, disconnect the AC adaptor cord and Ethernet cables and then connect again.
- If you are having problems making calls, disconnect the Ethernet cables and connect a known working Smart Desk Phone. If the known working Smart Desk Phone operates properly, have the defective Smart Desk Phone repaired by an authorized service center. If the known working Smart Desk Phone does not operate properly, check the SIP server and the Ethernet cables.

- Under power failure conditions, the Smart Desk Phone may not operate. Please ensure that a separate telephone, not dependent on local power, is available for use in remote sites in case of emergency.
- For information regarding network setup of the Smart Desk Phone such as IP addresses, please see page 115.
- If an error message is shown on your display, consult your phone system dealer or the network administrator.
- Use only the correct Panasonic handset.

Data Security

We recommend observing the security precautions described in this section, in order to prevent the following:

- loss, disclosure, falsification, or theft of user information
- unauthorized use of the unit
- interference or suspension of use caused by an unauthorized party

We cannot be responsible for damages resulting from the misuse of this product.

User information is defined as the following:

- Contacts' names, phone numbers, and IP addresses
- Forwarding destination numbers
- Numbers stored in One-touch Dialing buttons
- Passwords used to log in to the Web user interface
- Call logs

Preventing Data Loss

- Use a personal computer to make periodic backups of recordings stored on the SD card.
- Keep a copy of all important data (such as contact lists) in case the machine malfunctions and data cannot be recovered.
- There is a risk that data stored or saved on the unit may be changed or deleted when, for instance, the unit is being repaired. To protect important data from unexpected damage, see Data Security (Page 9).

Preventing Data Disclosure

- Do not leave memory devices (e.g., SD cards) that contain important information unattended. Do not leave the unit unattended while an SD card is inserted.
- Do not leave the unit in a location where it can be accessed or removed without authorization.
- To avoid improper usage by a third party, engage the screen lock (Page 94) when you are away from your seat or otherwise leave the unit unattended.
- Store backups in a secure location.
- Do not store sensitive personal information in the unit.
- Personal information (such as the contact list and call log) can be registered and/or saved on this unit. To prevent data leakage or unexpected damages,

make a record of necessary user information, etc., and initialize the unit to return it to its factory settings in the following cases (Page 129).

Also, remove the SD card from the unit.

- When passing on or disposing of the unit
- When lending the unit
- When having the unit repaired
- Make sure the unit is serviced by only a certified technician.

Preventing Data Disclosure Over the Network

- To prevent unauthorized access, only connect the unit to a network that is properly managed.
- Make sure all personal computers that are connected to the unit employ up-to-date security measures.

Security Information

- Security settings, such as passwords, cannot be undone at Panasonic service centers. Take measures to prevent passwords from being lost or forgotten.
- If a password is forgotten, initialize the unit and configure the settings again. (See page 129 for initialization procedures.)
- For best security, set passwords that cannot be guessed easily, and change passwords periodically (Page 118, Page 119).
- Take care that the unlock pattern, PIN, or password for the unit are not seen by a third party while being input or otherwise become known by an unauthorized party.

Privacy and Right of Publicity

By installing and using this device, you are responsible for maintaining the privacy and usage rights of images and other data (including sound picked up by the microphone). Use this device accordingly.

- Privacy is generally said to be, "A legal guarantee and right not to have the details of one's personal life unreasonably publicized, and the right to be able to control information about oneself. In addition, right of publicity is a right not to have a likeness of one's face or figure photographed and publicized without consent".
- When the Automatic Answer feature is enabled, transmission begins as soon as a call is received. The receiver will begin transmitting as soon as the call is received at any time, from any caller. Please be aware when the Automatic Answer feature is enabled, there is a risk that due to an unexpected, automatically answered call, privacy rights may be violated or sensitive information may be transmitted to unauthorized parties.

Additional Information

Important Safety Instructions

When using this unit, basic safety precautions should always be followed to reduce the risk of fire, electric shock and injury to persons, including the following:

1. Do not use the unit near water, for example, near a bathtub, washbowl, kitchen sink, or laundry tub, in a wet basement, or near a swimming pool.
2. Avoid using a telephone (other than a cordless type) during an electrical storm. There may be a remote risk of electric shock from lightning.
3. Do not use the telephone to report a gas leak in the vicinity of the leak.

SAVE THESE INSTRUCTIONS

FCC and Other Information

This equipment has been tested and found to comply with the limits for a Class B digital device, pursuant to Part 15 of the FCC Rules. These limits are designed to provide reasonable protection against harmful interference in a residential installation. This equipment generates, uses, and can radiate radio frequency energy and, if not installed and used in accordance with the instructions, may cause harmful interference to radio communications. However, there is no guarantee that interference will not occur in a particular installation. If this equipment does cause harmful interference to radio or television reception, which can be determined by turning the equipment off and on, the user is encouraged to try to correct the interference by one or more of the following measures:

- Reorient or relocate the receiving antenna.
- Increase the separation between the equipment and receiver.
- Connect the equipment into an outlet on a circuit different from that to which the receiver is connected.
- Consult the dealer or an experienced radio/TV technician for help.

CAUTION

Any changes or modifications not expressly approved by the party responsible for compliance could void the user's authority to operate this device.

FCC Declaration of Conformity

Trade Name: Panasonic

Model Number: KX-UT670

Responsible Party:

Panasonic Corporation of North America
One Panasonic Way

Secaucus, NJ 07094 U.S.A.

Telephone No.: 1-800-211-PANA (7262)

This equipment complies with Part 68 of the FCC rules and the requirements adopted by the ACTA. On the bottom of the cabinet of this equipment is a label that contains, among other information, a product identifier in the format

US:ACJ.....

If requested, this number must be provided to the telephone company.

If trouble is experienced with this equipment, for repair or warranty information, please contact:

Panasonic Service and Technology Company-BTS
Center

415 Horizon Drive Bldg. 300 Ste. 350-B

Suwanee, GA 30024-3186

Connection to party line service is subject to state tariffs. Contact the state public utility commission, public service commission or corporation commission for information.

If your home has specially wired alarm equipment connected to the telephone line, ensure the installation of this equipment does not disable your alarm equipment. If you have questions about what will disable alarm equipment, consult your telephone company or a qualified installer.

WHEN PROGRAMMING EMERGENCY NUMBERS AND (OR) MAKING TEST CALLS TO EMERGENCY NUMBERS:

- a. Remain on the line and briefly explain to the dispatcher the reason for the call.
- b. Perform such activities in the off-peak hours, such as early morning or late evenings.

This equipment is hearing aid compatible.

When you hold the phone to your ear, noise might be heard in your Hearing Aid. Some Hearing Aids are not adequately shielded from external RF (radio frequency) energy. If noise occurs, use the speakerphone option (if applicable) when using this phone. Consult with your audiologist or Hearing Aid manufacturer about the availability of Hearing Aids which provide adequate shielding to RF energy commonly emitted by digital devices.

For users in Canada only

- This Class B digital apparatus complies with Canadian ICES-003.
- This product meets the applicable Industry Canada technical specifications.

Compliance with TIA-1083 standard

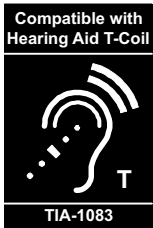

Telephone handsets identified with this logo have reduced noise and interference when used with T-Coil equipped hearing aids and cochlear implants.

About the touch screen

- Do not use commercially available display protection film. (The touch screen may function incorrectly.)
- The touch screen is easily damaged. Touch it only with your fingers.
- Do not touch the touch screen with a hard or sharp edge or tip, such as a ballpoint pen, or the tip of your finger nail.
- Do not press the touch screen with too much force.
- Do not rub the touch screen too strongly or otherwise handle it roughly.
- Do not place heavy items on the touch screen.
- If the unit is subject to a sudden change in temperature, such as immediately after turning on an air conditioner or heater, condensation may form on the inside of the touch screen and cause the screen to function incorrectly. In this case, cease operation and let the unit sit for 1 or 2 hours before using it again.
- The touch screen may become warm during operation, but this is normal.

Other

- This device is designed to be operated solely through the touch screen. Therefore, we highly recommend you have a secondary communication device available in case the touch screen is damaged.
- Sufficiently check the source and operations of all applications before installing. You may not be able to install or operate some applications, depending on the application. Also, be aware that applications

may contain viruses or may be able to access location data or personal data etc. stored on the unit. This data may then be leaked onto the Internet and used improperly.

- Panasonic cannot accept any responsibility if an installed application causes performance problems or losses of any kind to the user or a third party.

Table of Contents

Unit Overview	17
Included Accessories	17
Optional Accessories	17
Location of Controls	18
Before Operating the Telephone	23
Touch Display Operations	23
Basic Telephone Operations	24
Entering Text	25
Using the On-screen Keyboard	25
Using a USB Keyboard	29
Emergency Number Registration	30
The Display and Icons	31
The Display	31
Home Screen	31
Application Screen	34
Phone Screen	35
Calling Screen	37
Call Log Screen	40
Contacts Screen	41
Flexible Button Screen	42
Network Camera Viewer	43
Lock Screen	44
Icons	46
Phone	51
Making Calls	51
Confirming a Number Before Dialing (Pre-dialing)	51
Redialing	51
Calling from the Contacts Screen	51
Calling from the Call Log	52
Calling Using a Flexible Button Set as a One-touch Dialing Button	52
Calling an Emergency Number	52
Receiving Calls	53
Selecting from Multiple Incoming Calls	53
Answering a Call While on a Call (Answering Call Waiting)	53
Rejecting Calls	53
Holding a Call	54
Transferring a Call	55
Three-party Conference Call	55
Mute	56
Checking Voice Messages	56
Contacts	57
Adding Contacts	57
Adding a New Contact	57
Adding a Contact from the Call Log	58
Adding Network Camera Information to a Contact	58
Editing a Contact	59
Deleting a Contact	59
Searching for a Contact	60

Changing How Contacts are Displayed	60
Joining/Separating Contacts	61
Saving/Loading Contact Information to/from an SD Card	61
Save Format for Contact Data	61
Sending Contact Information as an E-mail Attachment	62
Assigning Ringtones to Specific Contacts	63
Network Camera	64
Registering a Network Camera	64
Selecting a Network Camera	65
Controlling a Network Camera	65
Calling a Phone Number Associated with a Camera	66
Switching Automatically among Multiple Cameras	67
Using Network Camera Presets	67
Adding a Preset to Your Favorites	67
Editing a Preset's Name	68
Configuring Display Properties	68
Adjusting the Brightness of the Picture	68
Automatic Mode	68
Receiving Alarms from Network Cameras	69
Configuring an Alarm Notification	69
Built-in Applications	71
Clock	71
Displaying the Date and Time	71
Setting an Alarm	71
Deleting an Alarm	72
Stopping an Alarm	72
Activating and Canceling Snooze	72
Using Alarm Clock's Menu	73
Browser	74
Displaying a Web Page in Browser	74
Using Bookmarks	74
Opening and Closing Windows	74
Setting the Home Page	75
Going Back to the Previous Page	75
Using Browser's Menus	75
Calculator	77
Using Calculator's Menu	77
Calendar	78
Displaying Calendar	78
Adding an Event	78
Checking an Event	79
Editing an Event	79
Deleting an Event	79
Canceling a Notification/Activating Snooze	79
Configuring Calendar's Settings	80
Email	81
Setting Up an E-mail Account	81
Creating and Sending a New E-mail Message	81
Reading E-mail	82
Viewing an Attachment	82
Forwarding an E-mail Message	82
Displaying a List of Folders	83
Deleting All Messages in the Trash	83

Adding an Account	83
Deleting an Account	84
Changing Account Settings	84
Gallery	85
Displaying an Image	85
Viewing Images as a Slideshow	85
Deleting an Image	85
Using Gallery's Menu	86
Music	87
Playing Music	87
Making a Playlist	87
Editing a Playlist	88
Search for Related Content in Browser	88
Using the Music Application's Menu	88
Advanced Settings	90
Forward/Do Not Disturb	90
Automatic Answer	91
Customizing Flexible Buttons	91
Using a Headset	93
Activating the Screen Lock	94
Customizing the Phone	95
Changing the Wallpaper	95
Adding and Deleting Shortcuts, Widgets and Folders	96
Displaying Your Schedule on the Phone Screen	97
Setting a Ringtone	98
Using Music on an SD Card as the Ringtone	98
Web User Interface Programming	99
Accessibility	100
Keyboard Operation	100
Connections and Installation	102
Attaching the Stand (Adjusting the Angle of the Unit)	102
Connections	104
Wall Mounting	108
Configuration	111
Making Settings	111
Setting Items	111
Setting Item Details	115
Miscellaneous Information	126
Updating the Firmware	126
Using an SD Card	126
Setting up a Google Account for Synchronizing	128
Initializing the Unit	129
Data Backup and Restore	129
Cleaning the Unit	130
Enabling Cleaning Mode	130
Troubleshooting	131
Specifications	139

Revision History	140
Software File Version 01.030	140
Index.....	141

Unit Overview

Included Accessories^{*1}

If any parts are missing or have other problems, contact your dealer.

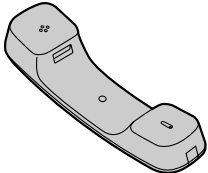
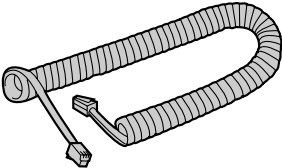
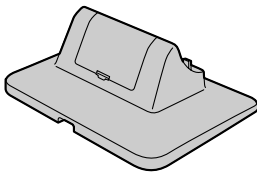
Handset (1)	Handset Cord (1)	Stand (1)
 <p>[Part No.] PNLXQ1001Z</p>	 <p>[Part No.] PNJA1068Z</p>	 <p>[Part No.] PNYLUT670M</p>

^{*1} For extra orders for the accessories, call toll-free: 1-800-332-5368. (For users in the United States only)

Note

- The illustrations may differ from the appearance of the actual product.

Optional Accessories

The following optional accessories are available for purchase:

AC Adaptor ^{*1}	KX-A422 (PNLV228)
Wall Mount Kit	KX-A434

^{*1} To order an optional AC adaptor, please order using the "KX-A422" model number.

Location of Controls

Front View

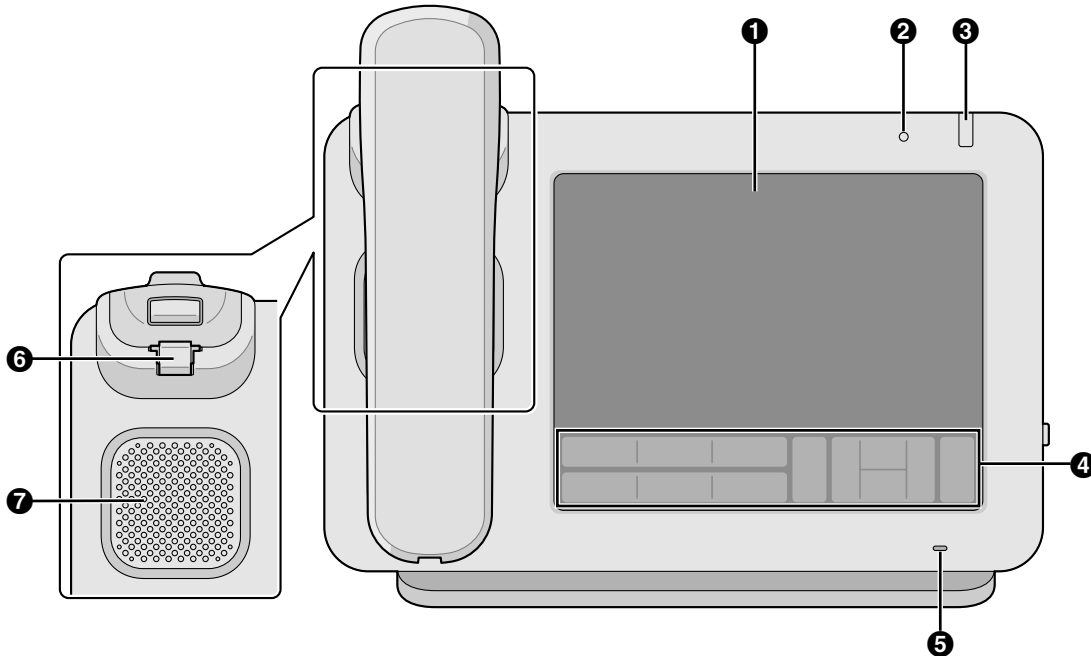

1 Touch Display (Page 23)

2 Ambient Light Sensor

Detects the brightness of the ambient light and adjusts the brightness of the display accordingly (Page 117).

3 Message/Ringer Lamp

The color of the lamp shows the unit's status as follows:

Color (state)	Unit Status
Green (flashing rapidly)	Receiving a call
Red (steady on)	New voice message Or, new voice message and missed calls
Green (flashing slowly)	Cleaning mode (for wiping the screen)
Green (steady on)	Missed calls

4 Key Sheet (Page 19)

5 Microphone

Used for hands-free conversation.



6 Handset Hook

Keeps the handset stable when the unit is mounted on a wall (Page 108).

7 Speaker

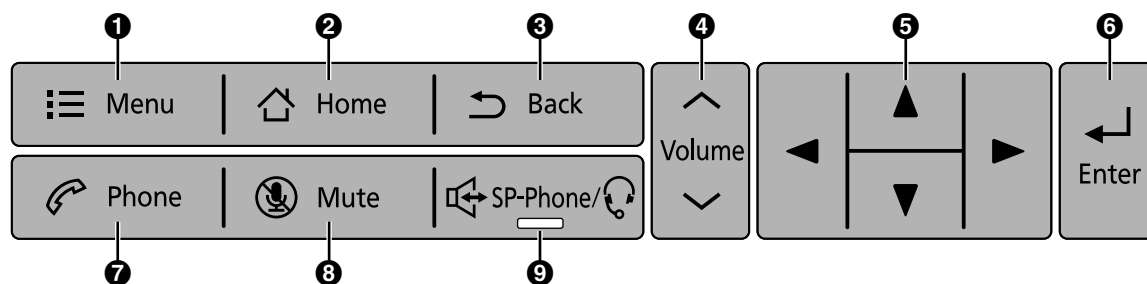
Key Sheet



- 1 Menu**
Display the menu. The contents of the menu differ depending on the current screen or application.
- 2 Home**
Return to the Home screen (Page 31). Pressing and holding this button displays the icons of the applications you have used since the unit started up. You can tap on an icon to switch to that application (Page 71).
- 3 Back**
Return to the previous screen.
- 4 Volume**
Adjust the volume. You can adjust the ringer and notification volume, the handset/speaker volume (available during a conversation), and the playback volume of the music application.
- 5 Navigation Key**
Select items on the screen, such as when searching for a contact or configuring settings.
- 6 Enter**
Confirms and accepts entered text or a changed setting value.
- 7 Phone**
Switch to the Phone screen (Page 35).
- 8 Mute**
During a conversation, mute the handset's and the unit's microphone so that the other party cannot hear you. While the microphone is muted, the light on  flashes red.
- 9 SP-Phone (Speakerphone)/Headset**
Make and receive calls without using the handset. If you are using a headset, pressing this button allows you to have a conversation using the headset. When  is active, the light on  lights red.

Right Side View

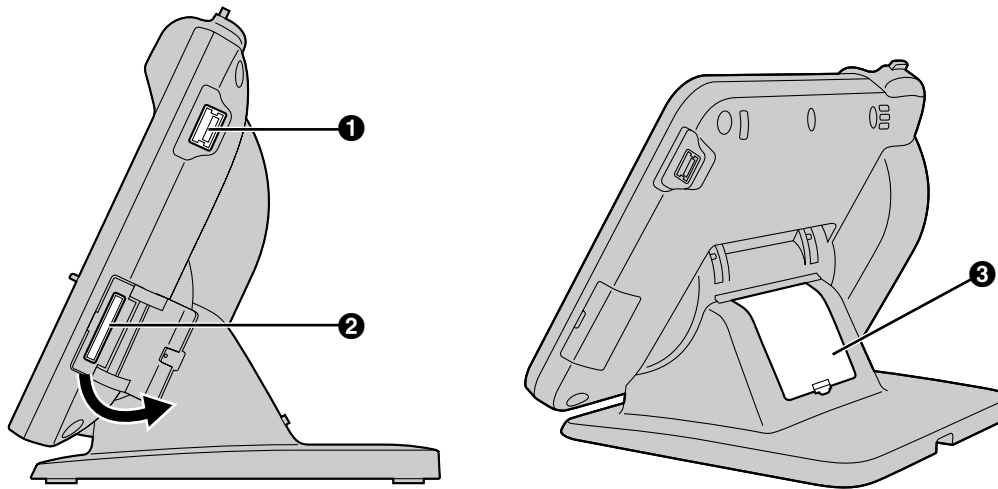

1 USB Port

Connect a USB keyboard (Page 107).

2 SD Card Slot

Insert an SD card. An SD card can be used for saving information stored on the unit, such as your contacts list, and for loading information onto the unit (Page 126).

3 Cable Cover

If the distance from the Ethernet cable connector to where the cable bends is greater than 30 mm (1 ³/₁₆ in), remove the cable cover (Page 105).

Left Side View

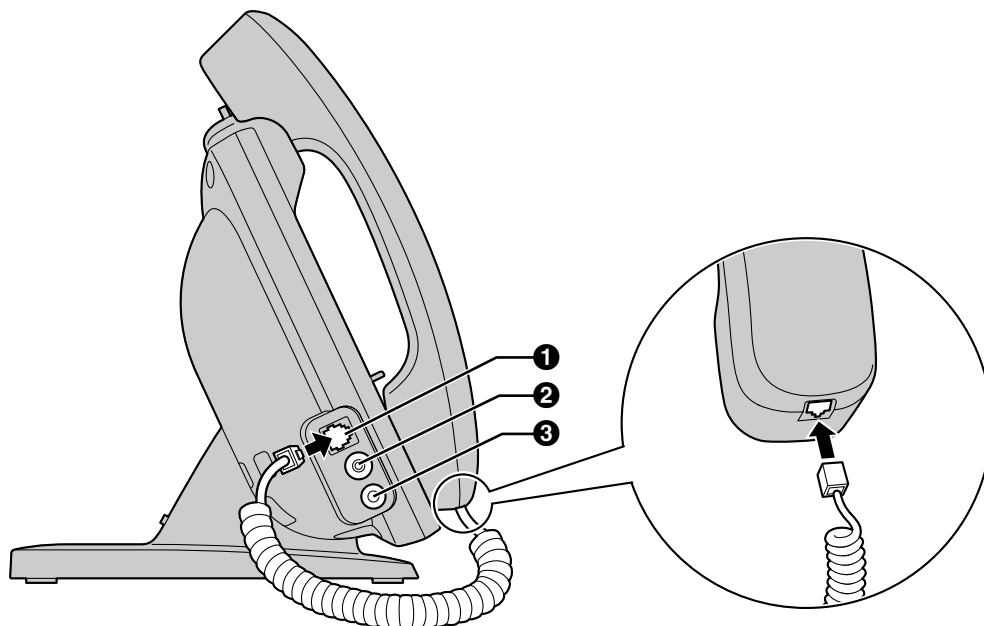

- ❶ **Modular Handset Jack**
- ❷ **EHS Jack**
Used to connect an EHS headset (Page 106).
- ❸ **Headset Jack (Page 106)**

Rear View

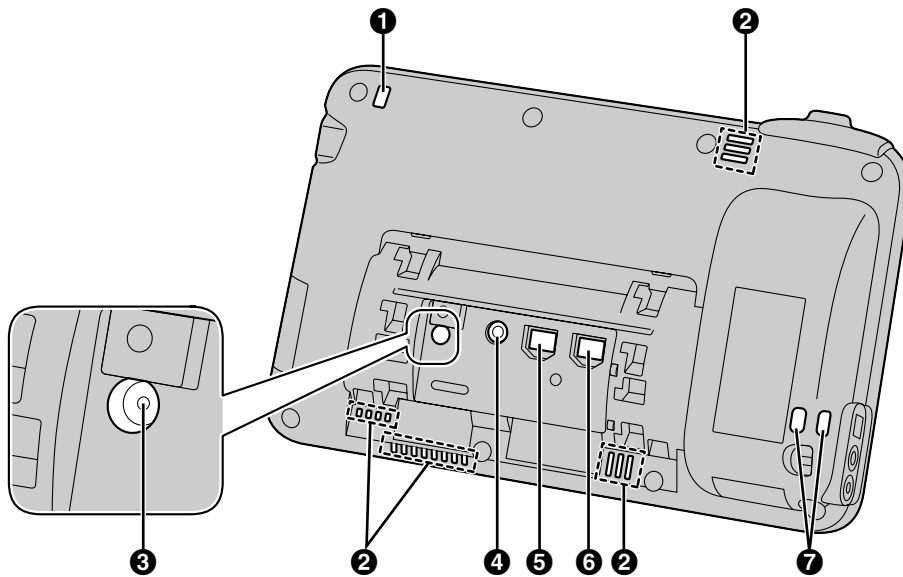

- 1 Message/Ringer Lamp (Page 18)**
- 2 Ventilation Opening (4 locations)**
- 3 RESET Button**
Reinitializes the unit's settings (Page 129).
- 4 DC Jack**
- 5 LAN Port**
- 6 PC Port**
- 7 Wire Openings**
For attaching an anti-theft cable or wire.

Before Operating the Telephone

Touch Display Operations

In this manual, touch operations are explained using the following terminology:

Touch

Touch the display with your finger.

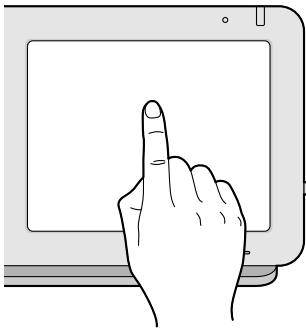

Tap

Touch the display only briefly.

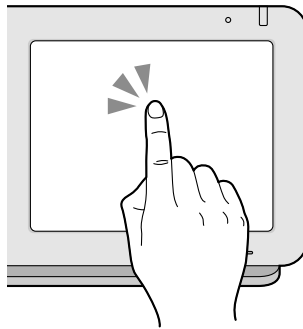

Touch and hold

Touch the display and keep your finger there.

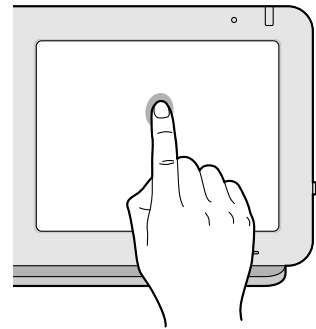

Swipe

Slide your finger across the display vertically or horizontally, and then lift your finger off the display.

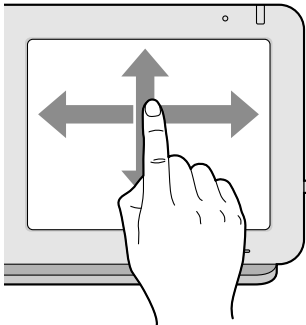

Drag

To move an object like an icon, touch and hold it with your finger, and then move it across the display. When you reach the destination, lift your finger.

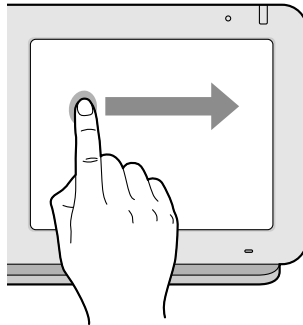

Notice

- When you use the touch display, use only one finger. Touching the display with more than one finger can result in unexpected behavior.

Basic Telephone Operations

With this unit, there are several ways to make and answer calls.

Going Off-hook

In this manual, when you see the phrase "go off-hook", you can do any of the following:

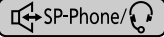
- Lift the handset off of its cradle.
- Press .
- On the Phone screen, tap a flexible button assigned as a DN (Directory Number) button.
- If a USB keyboard is connected, press the [F3] key.

Note

- If **[Answer]** is displayed on the screen, tapping **[Answer]** is the same as pressing .

Going On-hook

In this manual, when you see the phrase "go on-hook", you can do any of the following:



- Replace the handset on its cradle.
- Press , if you are in hands-free mode.
- If a USB keyboard is connected, press the [End] key, or if you are in hands-free mode, you can also press the [F4] key.

Note

- If **[Disconnect]** is displayed on the screen, tapping **[Disconnect]** ends the current call, but you remain off-hook (i.e., you will hear a dial tone).

Hands-free Mode

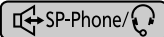
The following actions enable hands-free mode, where you can talk to and hear the other party without using the handset.

- In stand-by mode, press , and then make a call.
- During a call, press , and then replace the handset on its cradle.
- In stand-by mode on the Phone screen, tap a flexible button assigned as a DN button.
- If a USB keyboard is connected, press the [F3] key.

Lifting the handset off its cradle cancels hands-free mode.

Off-hook Monitor

The following action allows other people to listen to the conversation through the speaker while you continue the conversation using the handset.

- During a call, press .
- If a USB keyboard is connected, press the [F3] key.

Pressing  again cancels off-hook monitor. If a USB keyboard is connected, pressing the [F4] key also cancels off-hook monitor.

Note

- While off-hook monitor is enabled, replacing the handset on its cradle enables hands-free mode.

Entering Text

With this unit, you can enter text and other characters using either the on-screen software keyboard or an external USB keyboard (available commercially).

1. Tap the text box in which you want to enter text.
2. Use the keyboard to enter text.

Note

- When you tap a text box, the on-screen keyboard is displayed.
- If you touch and hold a text box, editing options such as **[Select text]**, **[Copy all]** and **[Paste]** become available.
- For details about the on-screen keyboard, see page 25.
- For details about USB keyboards, see page 29.

Using the On-screen Keyboard

This section explains how to use the on-screen keyboard to enter text.

Two keyboards are available on this unit: the "iWnn IME keyboard" and the "Android keyboard". The "iWnn IME keyboard" provides additional features such as Japanese input.

Selecting a Keyboard

1. Touch and hold a text box.
2. Tap **[Input method]**.
3. On the **[Select input method]** screen, select **[iWnn IME]** or **[Android keyboard]**.

Displaying/Hiding the On-screen Keyboard

To hide the on-screen keyboard

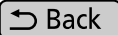
1. While the on-screen keyboard is displayed, press  **Back**.

To display the on-screen keyboard again

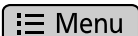
1. Tap the text box.
Or, touch and hold  **Menu**.

Using the iWnn IME Keyboard

This section explains how to use some of the features of the iWnn IME keyboard.









Sample screen shot of the keyboard



Note

- Depending on the input mode, the appearance of the keyboard may differ.

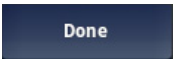
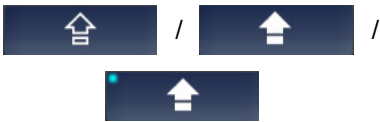
Function keys

Key	Description
	Deletes the character in front of the cursor.
	Moves the cursor one character to the left.
	Moves the cursor one character to the right.
	Displays the Symbol/Emoticon input screen.
	Switches to numeric and symbol input.
	Inserts a line break, accepts the currently entered text, etc.
	Accepts the entered text and moves to the next text box.
	Finishes input.
	Tapping once switches between uppercase and lowercase input. Tapping twice in a row enables caps-lock.
	Inserts a single space.

Using the Android Keyboard

This section explains how to input letters and numbers using the Android keyboard.

Sample screen shot of the keyboard



Note

- Depending on the input mode, the appearance of the keyboard may differ.

Function keys

Key	Explanation
	Tapping once switches between uppercase and lowercase input. Tapping twice in a row enables caps-lock.
	Deletes the character in front of the cursor.
	Accepts the entered text and moves to the next text box.
	Switches to numeric and symbol input.
	Inserts a single space. If multiple keyboard languages are enabled (Page 123), touching and holding this key and then swiping left or right changes the keyboard language.
	Switches to alphabetic input.
	Displays additional symbols.
	Inserts a line break, accepts the currently entered text, etc.
	Switches to symbol input.
	Finishes input.
	Begins a search using the entered text. This key is displayed in the Search widget (Page 96).

Note

- For details about Android keyboard settings, see Page 123.

Using a USB Keyboard

You can connect a standard USB keyboard and use it instead of the on-screen keyboard to enter text. The following keys can be used:

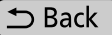
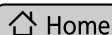
Key	Explanation
Alphanumeric characters and symbols (including the numeric keypad)	Used in the same way as input keys on the on-screen keyboard.
[Back space] key	Deletes the character in front of the cursor.
Arrow keys ([↑], [↓], [←], [→])	Move the cursor up, down, left, and right.
[Enter] key	Inserts a line break, accepts the currently entered text, etc.
[Esc] key	Functions the same as  Back on the key sheet.
[Home] key	Functions the same as  Home on the key sheet.
[Tab] key	Moves the cursor a fixed number of characters to the right.
[Shift] key	Used in combination with other keys or to switch between uppercase and lowercase letters.
[Alt] key	Used in combination with other keys. If an [AltGr] key is present on your keyboard, this key functions the same as [AltGr].
[AltGr] key ^{*1}	Used in combination with other keys.
Space bar	Inserts a single space.
Application key	Moves the cursor to the quick-search box. On the Contacts screen, the cursor is moved to the Contact search box (Page 60).

^{*1} Depending on your locality, this key may not be present on your keyboard.

Note

- When entering accented characters by combining the accent with a letter (e.g., by first entering "^" and then "e" to produce "ê") using a USB keyboard, be sure that the Android keyboard is selected (Page 25).
- To enter capital letters, use the [Shift] key. The [Caps Lock] key is not supported.
- This unit supports PC mode for Russian keyboards.
If Russian is specified as your language locale and you are using a USB keyboard, you can enter Latin characters by holding down the [Alt] or [AltGr] key while entering characters. For details about the language locale setting, see page 121.
- The functions of some keys may differ depending on whether accessibility mode is enabled (Page 100).
- For details about connecting a USB keyboard, page 107.

Emergency Number Registration

Registering emergency numbers allows you to select and call these numbers while the screen lock is active. Up to 5 emergency numbers can be registered.

1. On the Phone screen, press  **Menu**.
2. On the **[Menu]** screen, tap **[Edit Emergency Number]**.
3. Enter values in **[Label]** and **[Phone Number]**.
4. When you have finished entering the values, tap **[OK]**.

Note

- For details about dialing emergency numbers, see page 52.
- For details about entering text, see page 25.
- For details about activating the screen lock, see page 94.

The Display and Icons

The Display

Home Screen

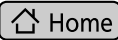
The Home screen is initially displayed when the unit is turned on. Also, pressing  displays the Home screen.

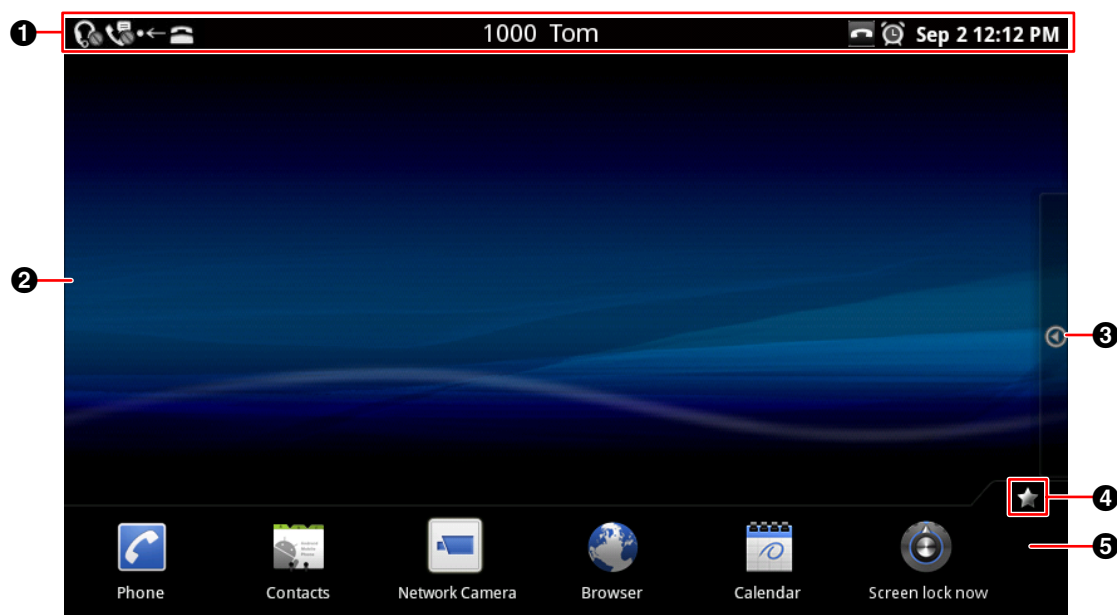

- ❶ Status bar (Page 32)
- ❷ Swipe left or right on the screen to display another Home screen. The Home screen is comprised of three screens, and you can freely position shortcuts, etc., on each screen.
- ❸ Tap here to display the Application screen (Page 34).
- ❹ Tap here to hide or show the application dock.
- ❺ Application dock
You can place frequently used applications in the application dock. Up to 7 applications can be placed here.
(For details about assigning applications to the application dock, see page 97.)

Status Bar

The status bar displays the status of the unit and is displayed on all screens. Tapping the status bar displays the notification screen.

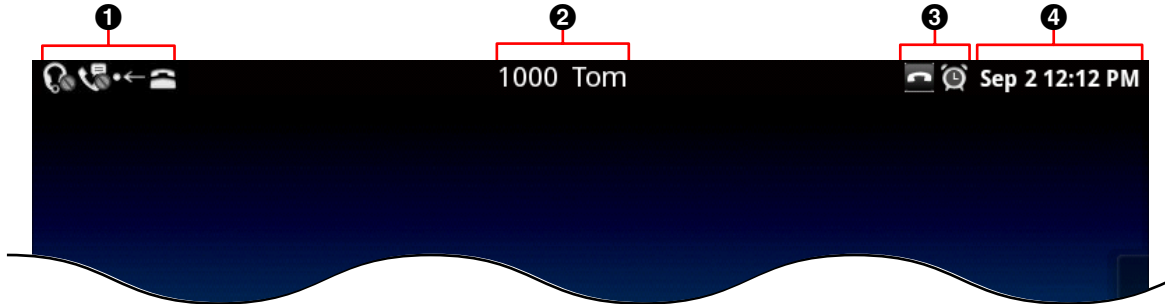

- ❶ Displays the status of unit settings, new mail notifications, etc.
- ❷ Displays the user's name and the unit's phone number.
If multiple lines are configured on your unit, the phone number of the default line is displayed.
- ❸ Displays the status of phone features.
- ❹ Displays the current date and time.
(For details about setting the date and time, see page 124.)

Note

- For details about the notification screen, see page 33.

Notification Screen

You can tap the items on the notification screen to display additional information.

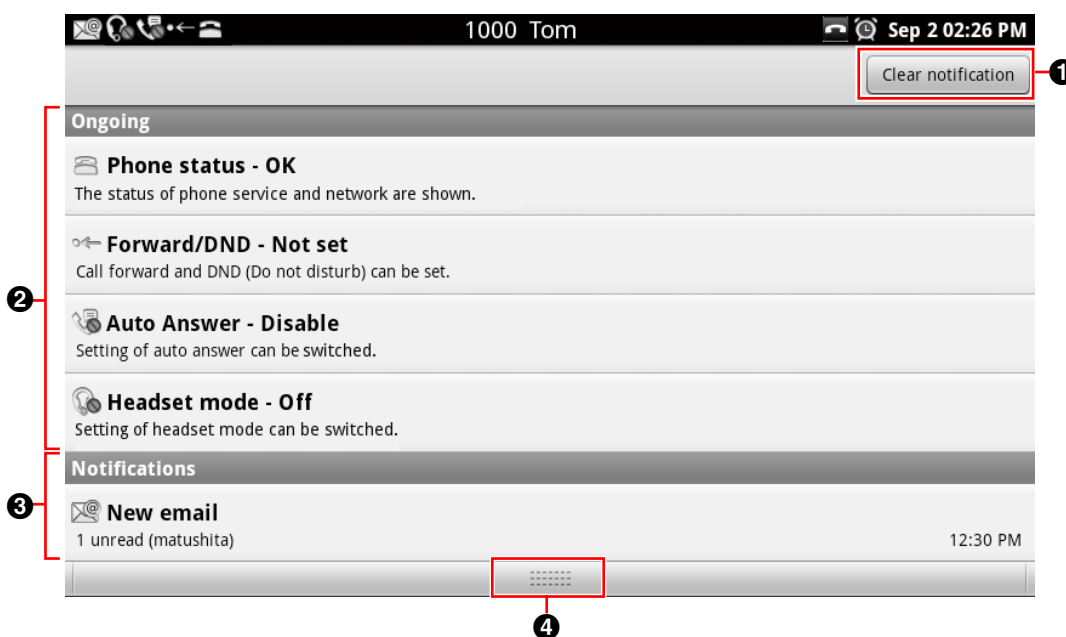

- ❶ Clears all notifications.
- ❷ Displays settings and status information for the unit.
You can tap each item to display additional information, change settings, etc.
- ❸ Displays current notifications.
Tap each item to launch the related application.
- ❹ Tap here to close the Notification screen.



Application Screen

The Application screen displays the applications installed on the unit. This screen is displayed when you tap  on the Home screen.



- ❶ Displays the applications installed on the unit (Page 71).
- ❷ Tap here to close the Application screen.

Phone Screen

After the unit is turned on and the Home screen is displayed, the Phone screen is displayed automatically. You can also press  or tap  on the Home screen to display the Phone screen.

Dial Key display

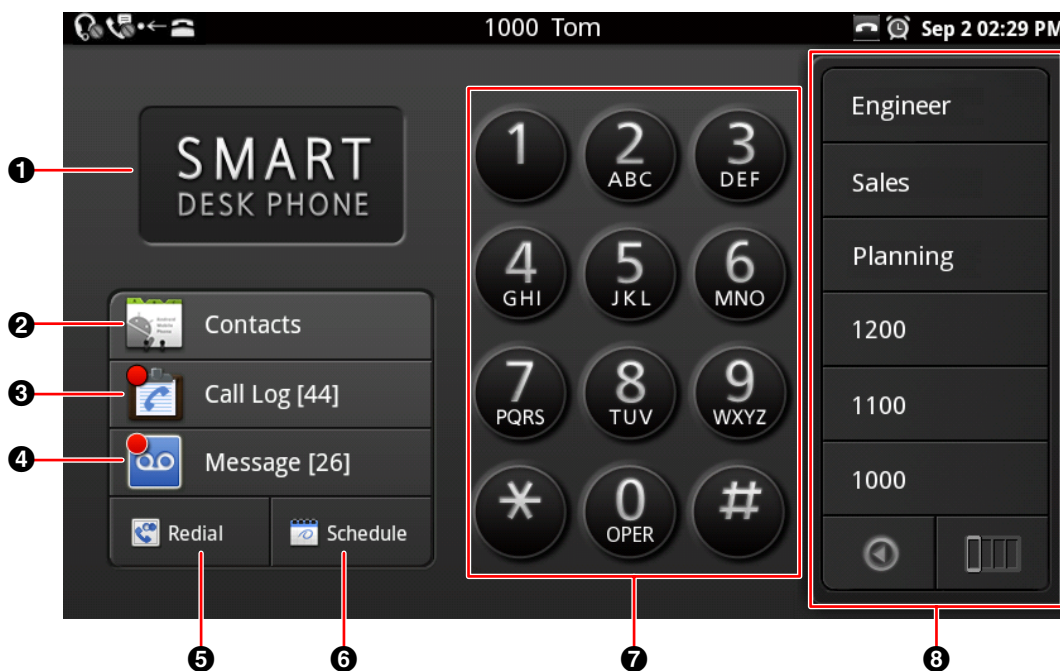

Schedule display

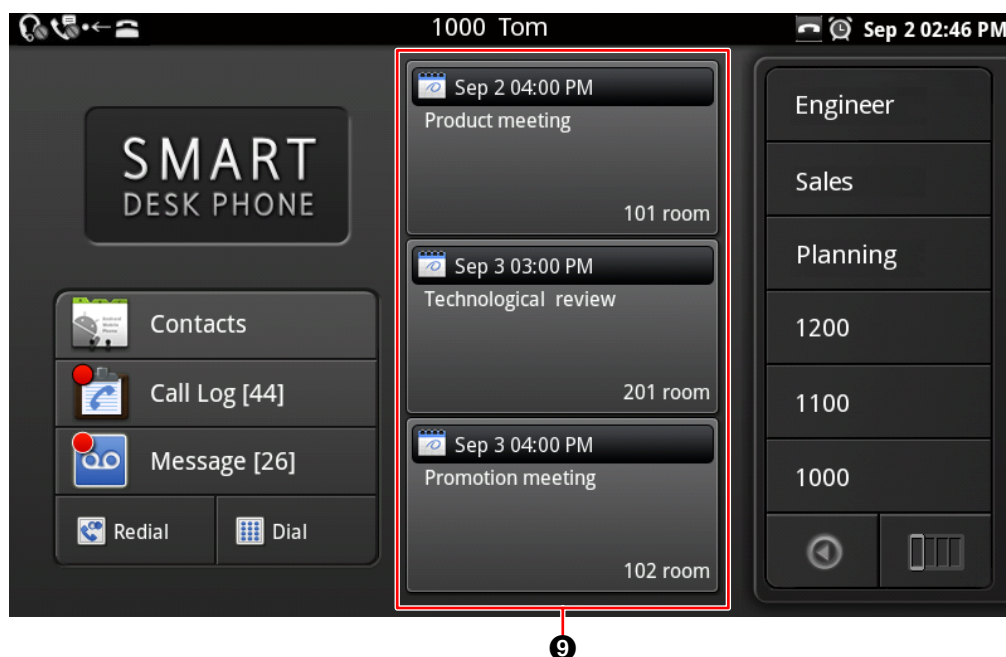

- ❶ Displays the wallpaper (Page 95).
- ❷ Displays your contacts (Page 41).
- ❸ Displays the call log (Page 40).
The number of missed calls is displayed in square brackets (e.g., [44]). If multiple lines are configured on your unit, the total number of missed calls on all lines is displayed.
- ❹ Checks your voice messages (Page 56).
The number of new messages is displayed in square brackets (e.g., [26]). If multiple lines are configured on your unit, the total number of new messages on all lines is displayed.
- ❺ Redials the last dialed phone number (Page 51).
- ❻ Temporarily changes the screen between the Dial Key display and the Schedule display.
(To display the Schedule display by default, see page 97.)
- ❼ Dial keys
- ❽ Flexible buttons (Page 42, Page 91)
- ❾ Displays up to 3 of the next upcoming events.
Tap an event to edit it. New events can be added by starting the Calendar application from the Home screen.





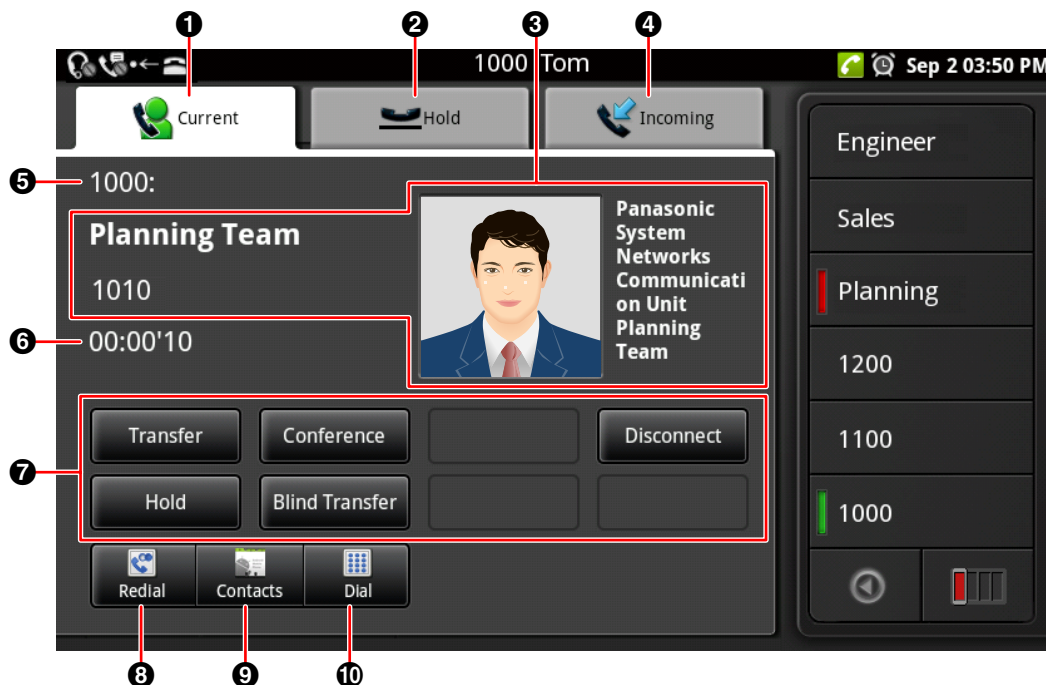

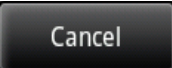

Calling Screen

During a call, the **[Current]** tab is displayed.

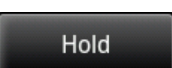

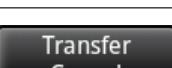
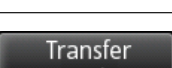
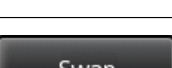
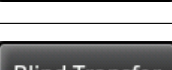
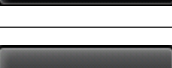
- ❶ **[Current]** tab
Displays information about the call in progress.
- ❷ **[Hold]** tab
Displays information about calls on hold.
- ❸ Personal information
If the other party is registered in your contacts, that person's information will be displayed.
- ❹ **[Incoming]** tab
Displays information about incoming calls.
- ❺ Displays information about the line being used (number, name, etc.).
- ❻ Displays the duration of the call.
- ❼ Soft keys (Page 38)
Buttons are displayed for features that can be used during a call.
- ❽ Redials the last dialed phone number (Page 51).
- ❾ Displays your contacts (Page 41).
- ❿ Displays the dial keys.

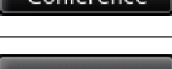
Soft Keys

Key	Description
	Deletes the last digit entered.
	Cancels pre-dialing and returns to the Phone screen (Page 51).
	Answers a call.
	Puts the current call on hold (Page 54).
	Retrieves a call on hold and resumes the call (Page 54).
	Transfers the call (Page 55).
	Cancels a transfer and resumes the call (Page 55).
	Connects a call to the transfer destination, and then hangs up (Page 55).
	When a call has been established with the transfer destination (second party), switches back to the first party (Page 55).
	Performs a blind transfer (Page 55).
	Adds a 3rd party to a 2-party call (Page 55).
	Begins a 3-party conference call (Page 55).
	Without you going on-hook, ends the current call but remains off-hook, or ends a 3-party conference call and returns to a 2-party call (Page 55).
	Rejects an incoming call (Page 53). This key is not displayed for Hold Recall or if the call is on a shared line. Note <ul style="list-style-type: none"> A shared line is a line that can be used by multiple units. This is an optional feature and may not be supported on your phone system.

Key	Description
 A dark grey rectangular button with the word "Flash" in white text.	Functionality depends on your phone system. For details, consult your administrator or dealer.

Call Log Screen

Tapping **[Call Log]** on the Phone screen displays the Call Log screen.

The Call Log screen displays the outgoing call log, incoming call log, and missed call log. The most recent 100 records are kept for each type of call log.

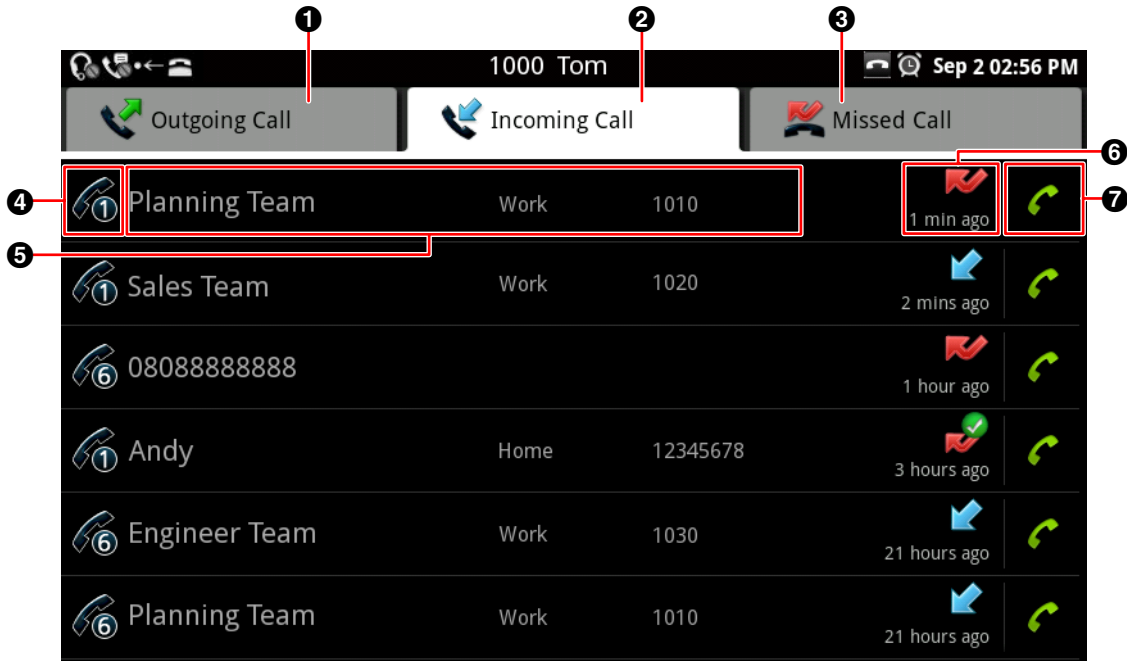

- 1 [Outgoing Call] tab**
Displays the outgoing call log.
- 2 [Incoming Call] tab**
Displays the incoming call log, including missed calls.
- 3 [Missed Call] tab**
Displays only missed calls.
- 4** Displays the line that was used when the call was made or received.
(Displayed only when multiple lines are configured on your unit.)
- 5** Call records
Display registered contact information, such as names and phone numbers. If there is no registered contact information, only the phone number is displayed.
- 6** Displays the date and time of the call.
The icon indicates the type of call (Page 48).
- 7** Tap to call the phone number associated with the call record.
If multiple lines are configured on your unit, the call is made from the line on which the original call was made or received.

Note

- If the registered information for a contact changes, the information will be reflected in the call log the next time the Call Log screen is opened.
- If the international dial code (+) is attached, the number will be displayed in the call log with a "+" attached.
- If an anonymous call is received, only **[Anonymous Call]** and the time of the call will be displayed. A call cannot be returned to an anonymous caller.

Contacts Screen

Tapping **[Contacts]** on the Phone screen or tapping  on the Home screen displays the Contacts screen.

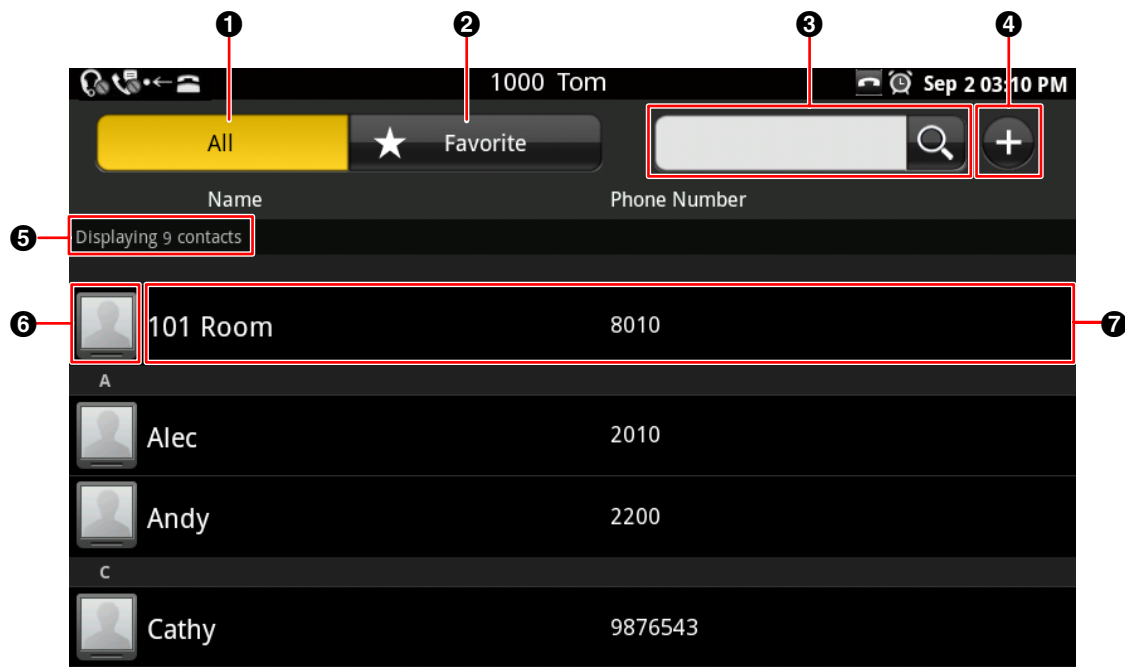

- ❶ Displays all contacts.
- ❷ Displays only contacts set as favorites (Page 57).
- ❸ Enter a name to search for contacts (Page 60).
- ❹ Add a new contact (Page 57).
- ❺ Displays the number of contacts in the currently displayed list.
- ❻ Photo
Tapping a photo displays the "quick contact" popup (Page 51).
Images stored on the SD card can be used for pictures (Page 57).
- ❼ Displays registered names and telephone numbers.
If multiple phone numbers are registered to a contact, the default number is displayed.
(For details about default numbers, see page 57.)

Flexible Button Screen

Single-row display



Full-screen display

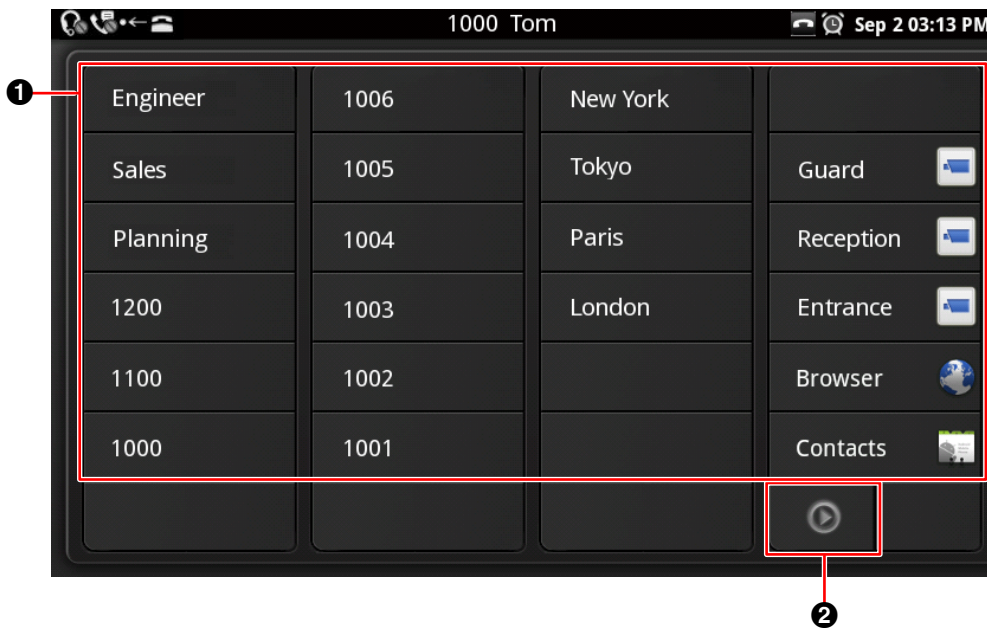

- ❶ Tapping a button activates the feature assigned to the flexible button.
- ❷ Switches between single-row display and full-screen display.
- ❸ Displays the next column.

Note



- For details about assigning features to flexible buttons, see page 91.

Network Camera Viewer

Tapping  on the Home screen starts Network Camera Viewer.

You can view the video feeds of network cameras connected to the network.



- ❶ Displays the video feed of the network camera.
- ❷ Displays the camera name as registered in the **[Camera Registration]** screen (Page 64).
- ❸ Returns to the camera's set home position (Page 66).
- ❹ Tap  to zoom in and  to zoom out (Page 65).
- ❺ Calls the phone number (paging number) associated with the network camera (Page 66).

Note

- For details about adding network cameras, see page 64.

Lock Screen

When someone taps the display while the screen lock is activated, the following screen is displayed.

When using a pattern

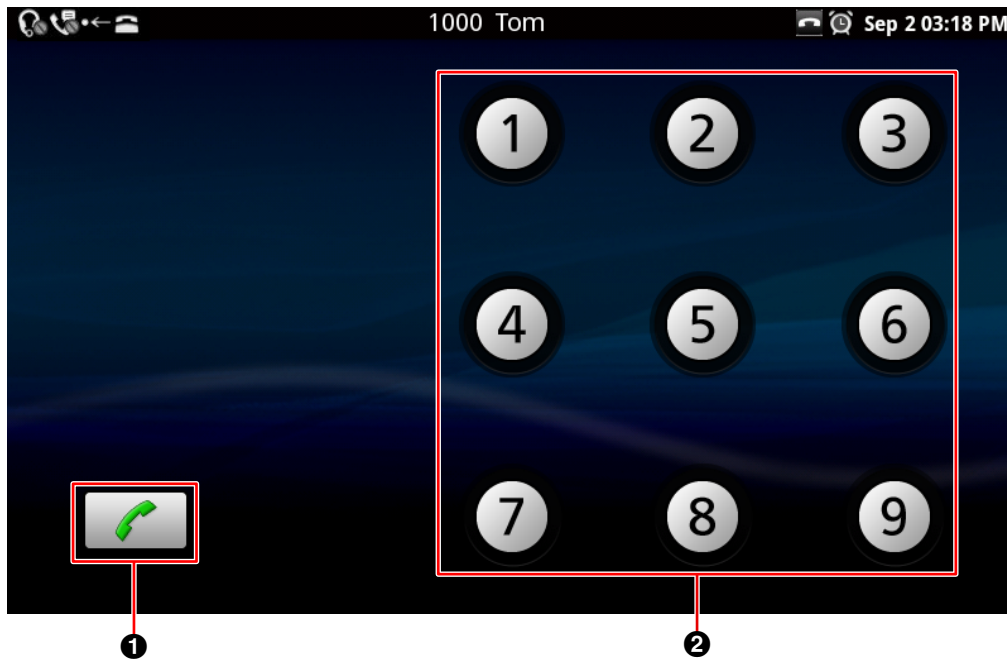

When using a PIN

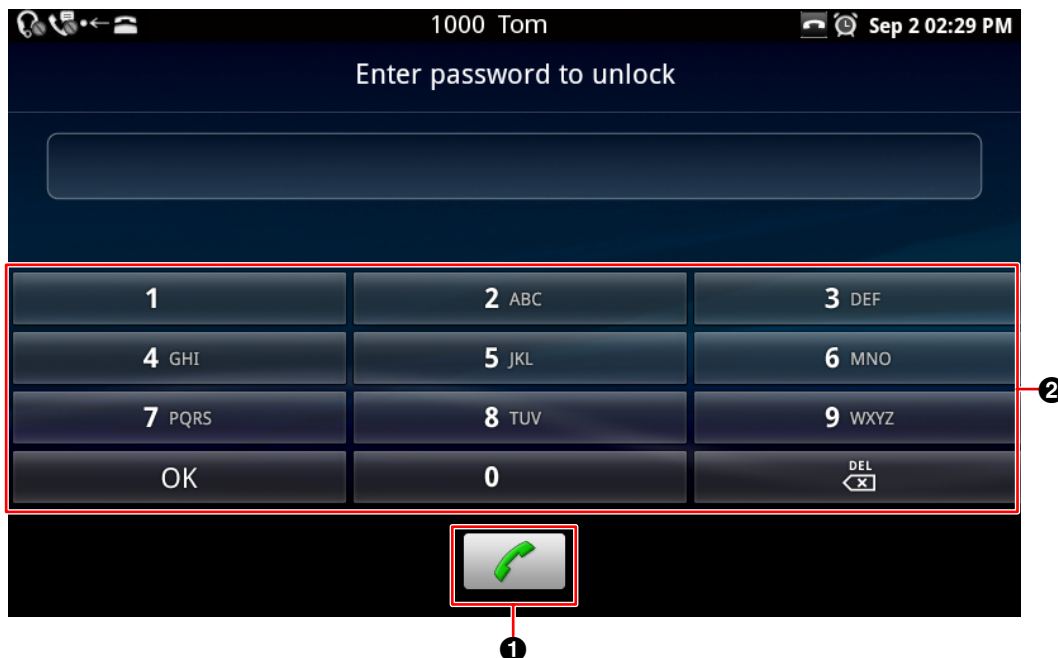

When using a password







- ❶ Call an emergency number (Page 52).
- ❷ Trace the unlock pattern, enter the PIN, or enter the password to unlock the screen (Page 94).

Note













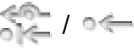



- For details about activating the screen lock, see page 94.













Icons

Home Screen (Page 31)







Icon	Description
	Displays the Application screen.
	Hides or displays the application dock.
	Closes the Application screen.
	Drag unneeded shortcuts, widgets, or folders to this icon to delete them (Page 97).









Status Bar (Page 32)

Icon	Description
	Displays the status of headset mode.  : On  : Off
	Displays the Call Forwarding (FWD) or Do Not Disturb (DND) status. If multiple lines are configured on your unit, the "set" icon is displayed when FWD or DND is enabled on any of the lines.  : Set  : Not set
	Displays the Auto Answer setting status.  : Enable  : Disable
	Displays the status of the calling service and the network. If multiple lines are configured on your unit, the "connection error" icon is displayed if there is a connection error on any of the lines.  : Connected without problems  : Connection error
	Displayed when an SD card inserted in the unit can be safely removed (i.e., has been successfully unmounted).
	Displayed while an SD card is inserted in the unit and ready to be used.
	Displayed when there is not enough free space available in the unit. When this icon is displayed, delete contacts, schedule items, or e-mails to make more space available.
	Displayed when an e-mail is received.
	Displayed while music is playing.



Icon	Description
	Displayed when an event's notification time is reached.
	Displayed as an alert for the following events: <ul style="list-style-type: none"> The SD card has been removed. An unsupported USB device has been connected to the unit. The USB hub pass-through limit has been exceeded. The demand for power from the USB port is too high.
	Displays the number of icons not being displayed on the status bar.
	Displayed when the alarm snooze feature is active.
	Displayed when an alarm is set (Page 71).
	Displays the status of the current call tab.  : In use (displayed when making a call, during a call, when in a conference call, etc.)  : Not in use (displayed when the line is idle, when receiving a call, etc.)
	Displayed when the ring volume is set to "0" (Page 116). When this icon is displayed, notification sounds are also muted.
	Displayed when a file download is completed.
	Displayed when an alarm is received from a network camera (only when status bar notification is specified) or when there is a setting error regarding the alarm port (Page 69).
	Displayed while contact or calendar synchronization is being performed (Page 128). If both are being synchronized, the icon is displayed twice.
	Displayed when contact or calendar synchronization has failed.

Phone Screen (Page 35)







Icon	Description
	Displays your contacts (Page 41).
	Displays the call log (Page 40).  : No missed calls.  : There are one or more missed calls. When the [Missed Call] tab is opened,  on the Phone screen will change to  .

Icon	Description
	Indicates whether there are new voice messages (Page 56).  : No new messages.  : There are one or more new messages.
	Redials the last dialed phone number (Page 51).
	Displays the schedule.
	Displays the dial keys.
	Switches between the single-row display and the full-screen display or flexible buttons.
	Displays the next column of flexible buttons in single-row display mode. The column with a border around it is the currently displayed row (for example: ). A row displayed in red indicates that the key currently being used is located in that row.

Calling Screen (Page 37)













Icon	Description
	Displays information about the current call.
	Displays information about calls on hold.
	Displays information about incoming calls.

Call Log Screen (Page 40)



Icon	Description
	Displayed for outgoing calls.
	Displayed for incoming calls that were answered.
	Displayed for missed calls that have been checked.
	Displayed for missed calls that have not been checked. When you tap the call record to display details about the call, or tap  to return the call, the icon changes to  .

Icon	Description
	Calls the other party.

Contact Screen (Page 41)

Icon	Description
	Enter a name to search for a contact (Page 60).
	Adds a new contact (Page 57).
	Calls the contact's default phone number.
	Sends an e-mail to the contact's default e-mail address.
	Displays the details screen for the selected contact.
	Sets the selected contact as a favorite.
	Calls the selected phone number.
	Write an e-mail to the selected e-mail address.
	Indicates the default phone number or e-mail address.
	Assigns an image stored in the SD card to a contact.
	Adds the selected editable item.
	Deletes the selected editable item.

Network Camera Viewer (Page 43)



Icon	Description
	Returns the network camera's angle, zoom level, and brightness to the camera-side defaults (Page 66).
	Zoom in/zoom out the network camera's video feed (Page 65).
	Brighten/darken the network camera's video feed (Page 68).

Icon	Description
	Dials the phone number (paging number) associated with the network camera (Page 66).

Lock Screen (Page 44)

Icon	Description
	Call an emergency number (Page 52).

Accounts & sync settings screen (Page 128)

Icon	Description
	Displayed if automatic synchronization is enabled.
	Displayed if automatic synchronization is disabled.
	Displayed while synchronization is being performed.

Phone

Making Calls

1. Go off-hook.
2. Enter the phone number.
3. To end the call, go on-hook.

Note



- You can enter up to 32 digits for the phone number.
- If the dialed number is registered to a contact, the contact's information is displayed.
- If a network camera is registered in the called party's contact information, Network Camera Viewer will start, and you can view the video feed from the camera.

Confirming a Number Before Dialing (Pre-dialing)

You can confirm the phone number you entered before it is dialed.

1. Enter the phone number with the handset still on its cradle.
2. Lift the handset, or press .
3. To end the call, go on-hook.

Note

- Tapping  deletes the last digit entered.
- Using the navigation keys ( and ) , you can move the cursor left and right.
- Tapping **[Cancel]** returns you to the Phone screen.
- You can enter up to 32 digits for the phone number.

Redialing

You can redial the last phone number that you dialed.

1. Go off-hook.
2. Tap **[Redial]**.
3. To end the call, go on-hook.

Note

- In step 1, tapping **[Redial]** without going off-hook enables hands-free mode.

Calling from the Contacts Screen

Calling Using "Quick Contact"

1. Go off-hook.
2. On the Phone screen, tap **[Contacts]**.
3. Tap the photo of the party you want to call.
4. Tap .
5. To end the call, go on-hook.

Note

- When multiple numbers are registered to a contact, the number specified as the contact's default number is dialed.
- If you use "quick contact" with a contact for which a default number is not specified, the following screen is displayed. Selecting the **[Remember this choice]** check box causes the phone number you select to be registered as the contact's default number.

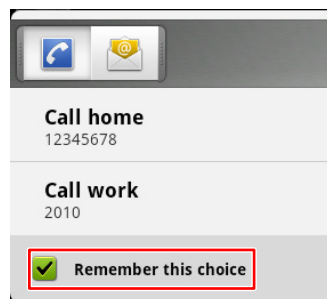

- If you tap a contact method other than telephone, the application associated with that contact method will start.

Selecting from Multiple Numbers Registered to a Contact

1. Go off-hook.
2. On the Phone screen, tap **[Contacts]**.
3. Tap the name of the party you want to call.
4. Tap the phone number you want to call.
5. To end the call, go on-hook.

Calling from the Call Log

1. Go off-hook.
2. Tap **[Call Log]**.
3. Select the **[Outgoing Call]** tab, the **[Incoming Call]** tab, or the **[Missed Call]** tab.
4. Tap the record for the party you want to call.
5. To end the call, go on-hook.

Note

- If you want to call a different phone number registered to the contact or use a different contact method, stay on-hook, tap the record, and then select **[View contact]**. You can then select a different phone number or contact method on the contact's details screen.

Editing a Phone Number before Calling

1. On the Phone screen, tap **[Call Log]**.
2. Select the **[Outgoing Call]** tab, the **[Incoming Call]** tab, or the **[Missed Call]** tab.
3. Touch and hold the record for the party you want to call.
4. Tap **[Edit number before calling]**.
5. Edit the phone number, and then go off-hook.

Note

- For details about pre-dialing, see page 51.

Deleting Records from the Call Log

To delete 1 record from the call log

1. On the Phone screen, tap **[Call Log]**.
2. Select the **[Outgoing Call]** tab, the **[Incoming Call]** tab, or the **[Missed Call]** tab.
3. Touch and hold the record you want to delete.
4. Tap **[Remove from call log]**.

To delete all records from the call logs

1. On the Phone screen, tap **[Call Log]**.
2. Press  **Menu**.
3. Tap **[Clear all call log]**.
4. On the **[Clear]** screen, tap **[OK]**.

Note

- All records in the outgoing call log, the incoming call log, and the missed call log will be deleted.

Calling Using a Flexible Button Set as a One-touch Dialing Button

You can use a flexible button configured as One-touch Dialing button to easily make calls.

1. Go off-hook.
2. Tap a flexible button configured as a One-touch Dialing button.
3. To end the call, go on-hook.

Note

- A flexible button configured as a BLF (Busy Lamp Field) button can also be used to call a local phone (Page 92).
- For details about registering One-touch buttons and BLF buttons, see page 91.

Calling an Emergency Number

While the screen lock is active, you can call an emergency number you registered beforehand.

1. Go off-hook.
2. Tap .
3. On the **[Select]** screen, tap the contact whom you want to call.

Note

- While you are on a call, incoming calls will not be received.
- For details about registering an emergency number, see page 30.
- For details about activating the screen lock, see page 94.

Receiving Calls

1. Go off-hook.
2. To end the call, go on-hook.

Note

- Enabling Automatic Answer allows you to answer an incoming call without going off-hook (Page 91).
- If a network camera is registered in the caller's contact information, Network Camera Viewer will start, and you can view the video feed from the camera.
- When you receive a call while using another application, the **[Incoming Call]** window is displayed.

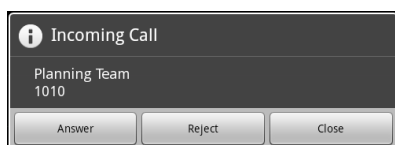

Selecting from Multiple Incoming Calls

When you have incoming calls from multiple parties at the same time, you can select which one to answer.

1. On the **[Incoming]** tab, select the call you want to answer.
2. Tap **[Answer]**.

Note

- The number of incoming calls is displayed on the **[Incoming]** tab.
- In the **[Incoming]** tab, incoming calls are displayed from the top in the order of oldest to newest.

Answering a Call While on a Call (Answering Call Waiting)

When you receive a second call while on another call, you can answer the second call after either putting the current call on hold or disconnecting it.

Disconnecting the Current Call and Answering the Second Call

1. When you hear the call waiting tone, go on-hook.
2. Go off-hook.

Holding the Current Call and Answering the Second Call

1. On the **[Incoming Call]** window, tap **[Close]**.
2. On the **[Current]** tab, tap **[Hold]**.
3. Tap the DN button (flexible button) of the incoming call (flashing green rapidly).

Note

- If automatic call hold is enabled through configuration file programming, simply tapping **[Answer]** on the **[Incoming Call]** window will put the current call on hold and answer the second call. For details, contact your administrator or dealer.

Rejecting Calls

You can reject an incoming call at your unit or set the unit to reject certain calls.

Rejecting a Call While Receiving

1. When receiving an incoming call, tap .

Rejecting Anonymous Calls

You can set the unit to reject calls when the unit receives a call without phone number. To reject anonymous calls, the Block Anonymous Call setting must be enabled through Web user interface programming (Page 99). For details, consult your administrator or dealer.

Note

- Rejected phone numbers will not be stored in the incoming call log.
- Depending on the line an incoming call is arriving on, the call may not be rejected.

Rejecting Specific Calls

You can set the unit to reject specific phone numbers.

Note

- Rejected phone numbers will not be stored in the incoming call log.

Adding a phone number

You can store a maximum of 30 phone numbers you want to reject in the rejection list of the unit.

1. On the Phone screen, press  **Menu**.
2. Tap **[Call Block setting]**.
3. Enter the phone number (max. 32 characters).
4. Tap **[OK]**.

Note

- To register additional telephone numbers, repeat the procedure from step 3.

Adding a phone number from the incoming call log

You can add a phone number by referring to the incoming call log.

1. On the Phone screen, tap **[Call Log]**.
2. Select the **[Incoming Call]** tab or the **[Missed Call]** tab.
3. Tap the phone number you want to reject calls from.
4. Tap **[Add to Call Block list]**.

Editing a stored phone number

1. On the Phone screen, press  **Menu**.
2. Tap **[Call Block setting]**.
3. Select the phone number you want to edit.
4. After you enter the phone number, tap **[OK]**.

Deleting a stored phone number

1. On the Phone screen, press  **Menu**.
2. Tap **[Call Block setting]**.
3. Select the phone number you want to delete.
4. Clear the displayed number.
5. Tap **[OK]**.

Holding a Call

1. On the **[Current]** tab, tap **[Hold]**.

Note

- When a call has been left on hold for a certain length of time, the **[Recall]** window is displayed and you will hear the recall tone.
- If Automatic Call Hold is enabled through configuration file programming, simply tapping a flexible button assigned as a DN button (Page 91) will put the call on hold. For details, contact your administrator or dealer.

Retrieving a Call on Hold

1. On the **[Hold]** tab, select the call you want to retrieve.
2. Tap **[Retrieve]**.

Note

- The number of calls on hold is displayed on the **[Hold]** tab.
- In the **[Hold]** tab, calls on hold are displayed from the top in the order of oldest to newest. Calls on hold waiting to be transferred or for a conference to start are displayed at the top of the list.

Transferring a Call

Transferring after the Destination Answers

1. During a call, tap **[Transfer]** on the **[Current]** tab.
2. Call the party to whom you want to transfer the call.
3. When the destination party answers, tap **[Transfer Complete]**.

Note

- For details about making a call, see page 51.
- In step 1, instead of tapping **[Transfer]**, you can tap a flexible button assigned as a BLF button to call the transfer destination.
- If On-hook Transfer is enabled at your unit, you can simply go on-hook in step 3 instead of tapping **[Transfer Complete]**. For details, consult your administrator or dealer.
- In step 3, instead of tapping **[Transfer Complete]**, you can tap **[Swap]** to put the transfer destination on hold and talk to the party you are transferring. Tapping **[Swap]** again returns you to the transfer destination.
- If the transfer destination does not answer, either tapping **[Transfer Cancel]** or tapping the DN flexible button for the call on hold (flashing green slowly) returns you to the original call.
- In step 3, the call will still be transferred even if you go on-hook before the transfer destination answers.

Transferring without Waiting for a Response from the Destination (Blind Transfer)

You can transfer a call to the transfer destination directly, without waiting a response from the destination.

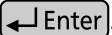
1. During a call, tap **[Blind Transfer]** on the **[Current]** tab.
2. Enter the transfer destination's phone number, and then press .
3. Go on-hook.

Note

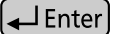
- For details about making a call, see page 51.
- In step 2, tapping **[Transfer Cancel]** before pressing  returns you to the original call.

Three-party Conference Call

During a two-party call, you can add a third party and establish a conference call.

1. During a call, tap **[Conference]** on the **[Current]** tab.
2. Call the party you want to add to the call.
3. When the third party answers, tap **[Start Conference]**, and the three-party conference begins.

Note

- For details about making a call, see page 51.
- If party you are adding to the call does not answer, tapping the DN flexible button of the call on hold (flashing green slowly) returns you to the two-party call.

Removing a Party from the Conference

To hold one party and talk with the other

You can put one of the parties on hold and establish a two-party call with the other party. It is also possible to return to the three-party conference.

1. During a three-party conference call, select the party you want to put on hold on the **[Current]** tab.
2. Tap **[Hold]**.

Note

- You can return to the three-party conference by tapping **[Start Conference]** after step 2.
- If you tap **[Hold]** without selecting a party, both of them are put on hold.

To disconnect one party and continue talking with the other

You can remove one of the parties from the conference and return to a two-party call.

1. During a three-party conference call, select the party you want to remove on the **[Current]** tab.
2. Tap **[Disconnect]**.

Ending a Conference Call



1. Go on-hook.

Mute

During a call, you can mute the microphone so that the other party cannot hear you. You will still be able to hear the other party, but they cannot hear you. The unit's microphone, the handset, and a connected headset will all be muted.

1. Press  Mute.

Note

- Pressing  Mute again cancels mute.
- While mute is active, the light on  flashes red.

Checking Voice Messages

When you have unheard voice messages, the **[Message]** icon appears as  on the Phone screen. Also, the Message/Ringer lamp lights red.

1. On the Phone screen, tap **[Message]**.
2. Follow the voice guidance.

Note

- To use this feature, the voice mail access number must be enabled through configuration file programming. For details, contact your administrator or dealer.
- If you are required to enter a password to listen to your voice messages, use the dial keys to enter the password. Tap **[Dial]** to display the dial keys, and then enter your password (Page 35).
- If multiple lines are configured on your unit, select the line on which you want to check voice messages after step 1.

Contacts

The Contact screen is displayed when you tap **[Contacts]** on the Phone screen or tap  on the Home screen.

Adding Contacts

Adding a New Contact

You can register multiple phone numbers and e-mail addresses to a single contact.

1. On the Phone screen, tap **[Contacts]**.
2. Tap .
3. Enter information as necessary.

Photo

Tap  to add a photo stored on an SD card. The file formats that can be used are JPEG, BMP, GIF, and PNG.

First and Last Name

Add a first and last name. Tap  to add a name prefix, a middle name, a phonetic name, etc.

Phone

Add a phone number. Tap  to add multiple phone numbers.

Email

Add an e-mail address. Tap  to add multiple e-mail addresses.

Postal address

Tap  to add an address.

Organization

Tap  to add departmental information.

More

Tap  to add a note, nickname, or a network camera or web site to the contact.

4. When you finish entering information, tap **[Done]**.

Note

- For details about entering text, see page 25.
- Tap  to delete the selected editable item.
- If you synchronize your contacts with a Google account (Page 128), note the following:
 - Photos in your contacts are not synchronized.

- Contacts with the same name on your unit and in your Google account are automatically joined.
- Existing contacts and any contacts you add will be added to the Google account.

Designating a Default Phone Number or E-mail Address



When multiple phone numbers or e-mail addresses have been added to a contact, a frequently used phone number or e-mail address can be designated for use with the "quick contact" feature to quickly contact another party.

1. On the Phone screen, tap **[Contacts]**.
2. On the Contact screen, tap the name of the contact.
3. Touch and hold the phone number or e-mail address to be used as the default.
4. Tap **[Make default number]**.

Note

- For making calls using "quick contact", see page 51.

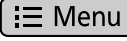
Deleting the Default Designation for a Phone Number or E-mail Address

1. On the Phone screen, tap **[Contacts]**.
2. On the Contact screen, tap the name of the contact.
3. Press .
4. Tap **[Edit contact]**.
5. Press .
6. Tap **[Clear Default]**.

Setting Favorites

By setting a contact as a favorite, you can easily access that contact's information.

1. On the Phone screen, tap **[Contacts]**.
2. Tap the name of the contact you want to set as a favorite.
3. Tap .

Note

- Tapping **[Favorite]** on the Contact screen will display the contacts registered as favorites (Page 41).

Adding a Contact from the Call Log

You can add contacts from phone numbers recorded in the call log.

1. On the Phone screen, tap **[Call Log]**.
2. Select the **[Outgoing Call]** tab, the **[Incoming Call]** tab, or the **[Missed Call]** tab.
3. Tap the record with the phone number you want to add.
4. Tap **[Create new contact]**.
5. Enter information as necessary.
6. When you finish entering information, tap **[Done]**.

Note

- For details about the entry items, see page 57.

Adding a Phone Number to an Existing Contact





1. On the Phone screen, tap **[Call Log]**.
2. Select the **[Outgoing Call]** tab, the **[Incoming Call]** tab, or the **[Missed Call]** tab.
3. Tap the call record with the number you want to add.
4. Tap **[Add to contacts]**.
5. Select the contact to add the phone number to.
6. Enter information as necessary.
7. When you finish entering information, tap **[Done]**.

Note

- For details about the entry items, see page 57.

Adding Network Camera Information to a Contact

A network camera that has been configured to connect to this unit can be added to a contact's information. The video feed of a registered network camera can be viewed during a conversation.

1. On the Phone screen, tap **[Contacts]**.
2. On the Contacts screen, tap the contact you want to add a network camera to.
3. Press  **Menu**.
4. Tap **[Edit contact]**.
5. Tap  in **[More]**.
6. Tap  next to the **[Network camera/Website]**.
7. Tap .
8. Select a network camera.
9. When you finish entering information, tap **[Done]**.

Note

- For details about entering text, see page 25.

Editing a Contact

You can edit the information registered to a contact.

1. On the Phone screen, tap **[Contacts]**.
2. Tap the name of the contact you want to edit.
3. Press  **Menu**.
4. Tap **[Edit contact]**.
5. When you finish entering information, tap **[Done]**.

Note

- For details about entering text, see page 25.

Deleting a Contact

Deleting One Contact

You can delete a contact.

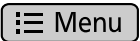
1. On the Phone screen, tap **[Contacts]**.
2. Tap the name of the contact you want to delete.
3. Press  **Menu**.
4. Tap **[Delete contact]**.
5. On the confirmation window, tap **[OK]**.

Note

- If Google account synchronization is enabled, deleting contacts on the unit also deletes them from your Google account.

Deleting All Contacts

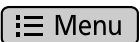
1. On the Phone screen, tap **[Contacts]**.
2. Press  **Menu**.
3. Tap **[Delete all]**.
4. Tap **[OK]**.

Note

- If Google account synchronization is enabled, deleting contacts on the unit also deletes them from your Google account.

Searching for a Contact

You can search for a contact within your registered contacts.

1. On the Phone screen, tap **[Contacts]**.
2. Tap , and enter the name of the contact you are searching for.
3. Tap one of the search results.

Note

- Each time you enter a letter, the search results list is refreshed.
- The search is not case-sensitive.
- You can also enter an e-mail address to search among registered e-mail addresses.
- For details about entering text, see page 25.

Changing How Contacts are Displayed

You can change how contacts are displayed in the contact list.

1. On the Phone screen, tap **[Contacts]**.
2. Press  **Menu**.
3. Tap **[Display options]**.
4. Select the display method.
Only contacts with phones
Display only contacts to whom a telephone number is registered.

Sort list by

Sort the list by first name (**First name**) or last name (**Last name**).

View contact names as

Select whether to display contacts' first name first (**First name first**) or their last name first (**Last name first**).

Joining/Separating Contacts

You can join the information of two separate contacts into a single contact, and you can separate joined contacts.

Joining Contacts

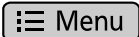
1. On the Phone screen, tap **[Contacts]**.
2. Tap the name of one of the contacts you want to join.
3. Press  **Menu**.
4. Tap **[Edit contact]**.
5. Press  **Menu**.
6. Tap **[Join]**.
7. Select the other contact you want to join with the first.
8. Tap **[Done]**.

Note

- When you load contact information from the SD card, if the name used already exists as a registered contact, the contacts will be automatically joined.

Separating a Contact

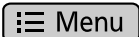
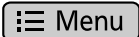
1. On the Phone screen, tap **[Contacts]**.
2. Tap the name of the contact you want to separate.
3. Press  **Menu**.
4. Tap **[Edit contact]**.
5. Press  **Menu**.
6. Tap **[Separate]**.
7. Tap **[OK]**.

Saving/Loading Contact Information to/from an SD Card

You can save (export) contact information to an SD card or load (import) contact information from an SD card.

Notice

- While contacts are being imported or exported, you cannot make or receive calls.

Note

- For details about using an SD card, see page 126.

Save Format for Contact Data

The contact data that is saved to an SD card, or can be loaded, is in the vCard™ format (file extension: .vcf). The vCard standard is defined by the IMC (Internet Mail Consortium). For details on the vCard standard refer to the following web site.

<http://www.imc.org/>

Data in this format can be sent as an e-mail attachment using the contact sharing feature.

vCard format example (for one contact)

```
BEGIN:VCARD
VERSION:2.1
N:White;Andy;;;
FN:Andy White
TEL;HOME;FAX:000-000-0000
EMAIL;HOME:andy@st.org
URL:http://www.matu.net/
URL:http://www.matu.or.jp
SOUND;X-RINGTONE;NUM:1
END:VCARD
```

Notice

- When editing vCard files on your computer using a text editor, be sure to save the file using the UTF-8 character encoding.

Saving to an SD Card

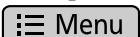
1. On the Phone screen, tap **[Contacts]**.
2. On the Contacts screen, press  **Menu**.
3. Tap **[Import/Export]**.
4. Tap **[Export to SD card]**.

5. On the **[Confirm export]** screen, tap **[OK]**.

Note

- Tapping **[Cancel]** returns you to the Contacts screen.

Loading from an SD Card

1. On the Phone screen, tap **[Contacts]**.
2. On the Contacts screen, press  **Menu**.
3. Tap **[Import/Export]**.
4. Tap **[Import from SD card]**.
5. On the **[Confirm import]** screen, select whether to back up the data.
6. Tap **[OK]**.
7. On the **[Select vCard file]** screen, select an import type.

Import one vCard file

Import one specified file.

Import multiple vCard files

Select multiple files and import them.

Import all vCard files

Import all files.

8. Tap **[OK]**.
9. On the **[Select vCard file]** screen, select the files to import.
10. Tap **[OK]**.

Note

- Tapping **[Cancel]** returns you to the Contact screen.
- If **[Import all vCard files]** is selected in step 7, steps 9 and 10 are omitted.
- If there is only 1 file on the SD card, steps 7 through 10 are omitted.
- If you have registered a Google account, any contacts you import from an SD card are automatically added to your Google account.
- For details about registering a Google account, see page 128.

Sending Contact Information as an E-mail Attachment

You can send contact information as an e-mail attachment.

Notice

- If an e-mail account has not been set up, first start the Email application and set up an e-mail account (Page 81).

Sending all contact information as an e-mail attachment

1. On the Phone screen, tap **[Contacts]**.
2. Press  **Menu**.
3. Tap **[Import/Export]**.
4. Tap **[Share visible contacts]**.
5. When the Email application has started, enter the recipient's address, a subject, and a message.
6. Tap **[Send]**.

Note

- For details about entering text, see page 25.

Sending one contact's information as an e-mail attachment

1. On the Phone screen, tap **[Contacts]**.
2. Tap the contact whose information you want to send.
3. Press  **Menu**.
4. Tap **[Share]**.
5. When the Email application has started, enter the recipient's address, a subject, and a message.
6. Tap **[Send]**.

Note

- For details about entering text, see page 25.

Assigning Ringtones to Specific Contacts

You can assign different ringtones to specific contacts.

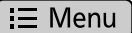
1. On the Phone screen, tap **[Contacts]**.
2. On the Contacts screen, tap the name of the contact to which you want to assign a ringtone.
3. Press  **Menu**.
4. Tap **[Options]**.
5. Tap **[Ringtone]**.
6. Select a ringtone on the **[Ringtone]** screen.
7. Tap **[OK]**.

Note

- If you specify a ringtone that is stored on an SD card and the SD card is removed, ringtone 1 will be used in place of the specified ringtone. When the SD card is re-inserted, the previously specified ringtone will be used.

Network Camera

On the Home screen, tap  to start Network Camera Viewer.



For up-to-date information about network cameras that have been tested with this unit, refer to the following web site:
<http://www.panasonic.com/sip> (for users in the United States)
<http://panasonic.net/pcc/support/sipphone> (for users in Canada)

Note

- To view a network camera's video feed from this unit, the network camera must be configured to use H.264 as its video codec.
- Depending on the camera model, some operations may not be available.

Registering a Network Camera

You can register up to 16 network cameras connected to the network.

1. On the Home screen, tap .
2. In Network Camera Viewer, press .
3. Tap **[Camera Registration]**.
4. In the **[Camera Registration]** list, tap the number of the entry you want to register the camera in.
5. Enter the necessary information.

Camera Name

Specify the camera's name. You can enter up to 20 characters.

Camera Address^{*1}

Enter the camera's IP address or FQDN (Fully Qualified Domain Name).

Port No.^{*1}

Enter the network camera's port number (1 to 65535).
 The factory default value is 80.

User ID

Enter the user name to use when connecting to the network camera (max. 32 alpha-numeric characters).

Password

Enter the password to use when connecting to the network camera (max. 32 alpha-numeric characters).

Paging No.

Enter the phone number associated with the camera (max. 32 characters).

Position of image

Specify the crop area for the image displayed in Network Camera Viewer. This unit supports VGA and 720p. If the network camera's video feed is currently being received,  indicates the current resolution (VGA or 720p).

Stream

If the camera is configured to output multiple streams, select which stream from the video camera to view (**Stream 1/Stream 2**). For details, refer to your camera's documentation.



^{*1} Required item.

6. When you have finished entering the necessary items, tap **[OK]**.

Note

- If a network camera is registered to a contact, you can view the video feed from the network camera while you are on a call with that contact (Page 58).
- In the **[Camera Registration]** list, a check mark is displayed on numbers to which a camera is already registered. The camera's name is also displayed, if one was specified.
- Tapping **[Cancel]** returns you to the **[Camera Registration]** list.
- For details about entering text, see page 25.

Selecting a Network Camera

1. On the Home screen, tap .
2. In Network Camera Viewer, press .
3. Tap **[Camera Select]**.
4. Tap a camera's name in the **[Camera Select]** list.
5. Tap **[Close]**.

Note

- If a name is not specified for a camera, a number is displayed in the **[Camera Registration]** list instead (e.g., Camera 1).
- The next time you start Network Camera Viewer, the video feed of the camera that was selected the previous time is displayed.

Controlling a Network Camera

Changing the View Area

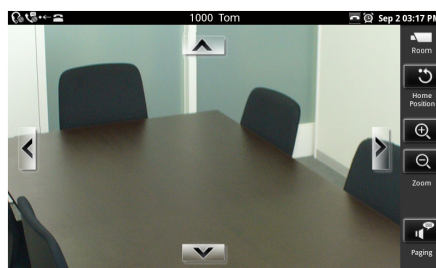
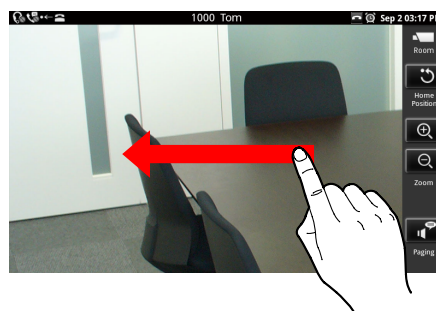

1. On the Home screen, tap .
2. Swipe across the network camera's video-feed display.



Note

- If you swipe quickly, the view may continue to move even after you release your finger.

Zooming In and Out



1. On the Home screen, tap .
2. In Network Camera Viewer, tap  (zoom in) or  (zoom out).

Centering the View on a Tap

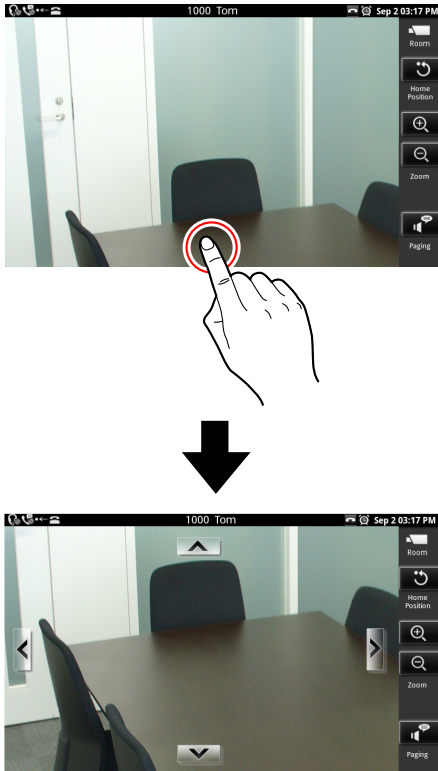
1. On the Home screen, tap .
2. Tap the display where you want to center the view.



Returning the View to Home Position (set in the camera)



1. On the Home screen, tap .
2. In Network Camera Viewer, tap .

Note

- The zoom and brightness settings are also returned to their "home" settings.

Calling a Phone Number Associated with a Camera

You can call a phone number that is associated with a network camera, called a paging number. The number is dialed from Network Camera Viewer while the camera's video feed is being displayed. The Phone screen is not displayed.

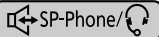

1. On the Home screen, tap .
2. In Network Camera Viewer, tap .
3. When you hear the confirmation tone, or the other party answers, begin speaking.
4. To end the call, press .

Note

- For details about registering a paging number, see page 64.

Switching Automatically among Multiple Cameras

You can have the unit cycle through the registered network cameras and display each video feed in turn.

1. On the Home screen, tap .
2. In Network Camera Viewer, press .
3. Tap **[Camera Select]**.
4. In the **[Camera Select]** list, tap **[Sequential]**.
5. Tap **[Close]**.

Note

- When automatic switching begins, the currently selected network camera's video feed is displayed first, and then video feeds are displayed in the order in which cameras are listed in the **[Camera Select]** list.
- Selecting a network camera in the **[Camera Select]** list ends automatic switching.
- If you touch the display, automatic switching will temporarily stop on the current video feed. To resume switching, tap **[Sequential]** again. While switching is temporarily stopped, doing other operations such as selecting a network camera ends automatic switching.

Setting the Switching Interval

You can change the length of time video feeds are displayed before being switched.

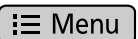
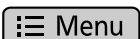

1. On the Home screen, tap .
2. In Network Camera Viewer, press .
3. Tap **[Camera Select]**.
4. Press .
5. Tap **[Sequential Interval]**.
6. Tap the desired length of time.

Note

- The factory default value is **[10 seconds]**.
- If automatic switching is already enabled, you can skip step 4.

Using Network Camera Presets

You can select a viewing position that has been registered in the network camera's settings beforehand. These are called "presets".

1. On the Home screen, tap .
2. In Network Camera Viewer, press .
3. Tap **[Preset]**.
4. After you tap **[Preset]**, select the camera position you want to view.
5. Tap **[Close]**.

Note

- You can view all the registered presets by scrolling the list up and down.
- Tapping **[Favorite]** in step 4 displays the presets registered as favorites.

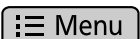

Adding a Preset to Your Favorites

1. On the Home screen, tap .
2. In Network Camera Viewer, press .
3. Tap **[Preset]**.
4. In the **[Preset]** list, touch and hold the preset you want to add to your favorites.
5. Tap **[Add to Favorites]**.

Note

- Tapping **[Cancel]** returns you to the **[Preset]** list.

Deleting from Your Favorites

1. On the Home screen, tap .
2. In Network Camera Viewer, press .
3. Tap **[Preset]**.
4. In the **[Preset]** list, tap **[Favorite]**.
5. Touch and hold the preset you want to delete from your favorites.
6. Tap **[Remove From Favorites]**.

Note

- Tapping **[Cancel]** returns you to the **[Preset]** screen.

Editing a Preset's Name

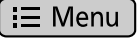
1. On the Home screen, tap .
2. In Network Camera Viewer, press .
3. Tap **[Preset]**.
4. In the **[Preset]** list, touch and hold the preset whose name you want to edit.
5. Tap **[Edit Preset Name]**.
6. Edit the preset's name as necessary, and then tap **[OK]**.

Note

- Tapping **[Cancel]** returns you to the **[Preset]** screen.
- For details about entering text, see page 25.

Deleting a Preset's Name that You Edited

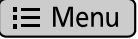
1. On the Home screen, tap .
2. In Network Camera Viewer, press .
3. Tap **[Preset]**.
4. In the **[Preset]** list, touch and hold the preset whose name you want to delete.
5. Tap **[Delete Preset Name]**.





Note

- Deleting a preset's name returns it to its default value (**Preset**).
- Tapping **[Cancel]** returns you to the **[Preset]** screen.

Configuring Display Properties

You can adjust the brightness of the network camera and set up automatic mode.

Adjusting the Brightness of the Picture

1. On the Home screen, tap .
2. In Network Camera Viewer, press .
3. Tap **[Camera Settings]**.
4. Tap **[Brightness]**.
5. Tap  (brighter) or  (darker) to adjust the brightness.
6. Tap **[Close]** to save the setting.



Note

- Tapping **[Reset]** in step 5 returns the setting to the value specified in the camera's settings.

Automatic Mode

Auto Pan

The camera can be set to pan horizontally (left–right) over its entire viewing range repeatedly.



1. On the Home screen, tap .
2. In Network Camera Viewer, press .
3. Tap **[Camera Settings]**.
4. Tap **[Auto Mode]**.
5. On the **[Auto Mode]** screen, tap **[Auto Pan]**.

Note

- Tapping **[Cancel]** returns you to the **[Camera Settings]** screen.

Preset Sequence

You can have the camera cycle through and display viewing positions registered as presets.

1. On the Home screen, tap .
2. In Network Camera Viewer, press .
3. Tap **[Camera Settings]**.
4. Tap **[Auto Mode]**.



- On the **[Auto Mode]** screen, tap **[Preset Sequence]**.

Note

- Tapping **[Cancel]** returns you to the **[Camera Settings]** screen.

Automatic Tracking



You can have the camera automatically follow a moving object.

- On the Home screen, tap .
- In Network Camera Viewer, press .
- Tap **[Camera Settings]**.
- Tap **[Auto Mode]**.
- On the **[Auto Mode]** screen, tap **[Auto Tracking]**.

Note

- Tapping **[Cancel]** returns you to the **[Camera Settings]** screen.

Canceling Automatic Mode

- On the Home screen, tap .
- In Network Camera Viewer, press .
- Tap **[Camera Settings]**.
- Tap **[Auto Mode]**.
- On the **[Auto Mode]** screen, tap **[Off]**.

Note

- Changing the viewing direction in Network Camera Viewer, such as by swiping or tapping  also cancels automatic mode.
- If another user accesses the same network camera and cancels automatic mode or changes the viewing direction, automatic mode will be canceled for everyone.

Receiving Alarms from Network Cameras

When an alarm from a network camera (movement detection, error, abnormality, etc.) is detected, this unit can display the video feed from the camera that issued the alarm.

Configuring an Alarm Notification

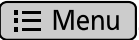
- On the Home screen, press .
- Tap **[Settings]**.
- Tap **[Network Camera]**.
- Tap **[Alarm notification]**.
- Select a notification method:

Pop up live screen

A notification alarm will sound, and the video feed from the camera that issued the alarm will be displayed.

Pop up live screen or status bar notification

A notification alarm will sound, and then one of the following will occur:

- If you are viewing a video feed from any camera, the camera name +  will be displayed in the status bar.
- Otherwise, the video feed from the camera that issued the alarm will be displayed.

Status bar notification

A notification alarm will sound, the camera name +  will be displayed in the status bar.

- Tap **[OK]**.

Note

- To prevent the Network Camera Viewer from switching too frequently between video feeds when several alarms are issued in a short time span, an alarm disarm time is set (default: 2 seconds). For details about the alarm disarm time, see page 125.
- The video feed that is displayed when an alarm is detected is the current video feed, not the feed from the time the alarm was issued.
- The video feed displayed in Network Camera Viewer when an alarm is issued does not automatically close, even after some time has passed.

- If you are viewing the video feed from a camera when it issues an alarm, only a notification alarm will sound.
- Notifications on the Notification screen are displayed in order, newest first. New notifications from a network camera overwrite previous notifications from that camera, so only the most recent notification from any given camera is displayed.
- If an error occurs regarding the alarm port number, such as a port number conflict,  is displayed in the status bar. For details about the alarm port setting, see page 125.

Disabling an Alarm Notification

1. On the Home screen, press  Menu .
2. Tap **[Settings]**.
3. Tap **[Network Camera]**.
4. Tap **[Alarm notification]**.
5. Select **[Off]**.
6. Tap **[OK]**.

Built-in Applications

This unit comes with a number of built-in applications you can use.

Starting an Application

1. On the Application screen, tap the icon of the application you want to start.

Clock





The unit can be used as a desktop alarm clock.

Displaying the Date and Time

When you start the Clock application, the current date and time are displayed prominently.

1. On the Application screen, tap .

Buttons and icons displayed on the Clock application's main screen

	Displays the alarm list
	Displays the Gallery application (Page 85)
	Displays the Music application (Page 87)
	Returns to the Home screen
	Dims the display. The display returns to its normal brightness at the next user action, such as touching the screen or lifting the handset.



Note

- On the Clock application's main screen, the day and time of the next alarm, if any is set, is displayed in the upper-left area. Tapping this displays the list of alarms.

Setting an Alarm



When an alarm is set,  is displayed in the status bar, and the alarm notification screen will be displayed at the time specified.

Adding a new alarm





1. On the Application screen, tap .
2. Tap .
3. Tap **[Add alarm]**, and then specify the time for the alarm.
4. Tap **[Set]**.

5. Specify the alarm tone or other items as necessary.
6. Tap **[Done]**.



Editing an alarm

1. On the Application screen, tap .
2. Tap .
3. Tap the alarm you want to edit.
4. Change the time, alarm tone or other items as necessary.
5. Tap **[Done]**.



Turning an alarm on or off

1. On the Application screen, tap .
2. Tap .
3. Tap the icon next to the alarm you want to turn on or off.
 - : The alarm is off; tap this to turn it on.
 - : The alarm is on; tap this to turn it off.



Note

- On the **[Alarms]** screen (displayed after tapping ) , tapping  displays the Clock application's main screen.

Deleting an Alarm

1. On the Application screen, tap .
2. Tap .
3. Tap the alarm you want to delete.
4. Tap **[Delete]**.
5. Tap **[OK]**.

Note

- On the **[Alarms]** screen (displayed after tapping ) , tapping  displays the Clock application's main screen.

Stopping an Alarm

At the specified time, the alarm's tone will sound and the alarm notification screen will be displayed.

1. On the alarm notification screen, tap **[Dismiss]**.

Activating and Canceling Snooze

Activating Snooze



When snooze is activated, the alarm will sound again after a specified length of time.

1. On the alarm notification screen, tap **[Snooze]**.



Canceling Snooze

1. Tap the status bar.
2. On the notification screen, tap **[Alarm (snoozed)]**.

Using Alarm Clock's Menu

1. On the Application screen, tap .
2. Tap .
3. Press  **Menu**.

You can configure the following settings:

Desk clock		Displays the clock over the entire display.
Add alarm		Add and set a new alarm.
Settings	Alarm volume	Set the alarm's volume.
	Snooze duration	Specify the length of time before the alarm sounds again when you tap [Snooze] on the alarm notification screen.
	Volume button behavior	Select the action that occurs when you press the volume keys ( , ) while the alarm is sounding. You can select [None] , [Snooze] , or [Dismiss] .





Browser

You can browse and view web pages.

Displaying a Web Page in Browser



1. On the Application screen, tap .
2. Tap the URL input box, and then enter a URL or some text to search the web for.
3. Tap **[Go]**.

Note



- If you entered search text in step 2, select the web page you want to view from the search results that are displayed.
- You can use  to enlarge () or shrink () the text on the screen.
 is displayed at the bottom of the screen when you scroll.
- For details about entering text, see page 25.

Using Bookmarks

Adding a Bookmark

1. On the Application screen, tap .
2. Display the web page that you want to bookmark.
3. Press  **Menu**.
4. Tap **[Bookmarks]**.
5. Tap **[Add]**.
6. Change the title of the bookmark as necessary, and then tap **[OK]**.

Displaying a Web Page from the Bookmark List



1. On the Application screen, tap .
2. Press  **Menu**.
3. Tap **[Bookmarks]**.
4. Tap the web site you want to view.

Opening and Closing Windows

Opening a New Window

1. On the Application screen, tap .
2. On the web page currently displayed in the browser, touch and hold a link to a page you want to view.
3. Tap **[Open in new window]**.

Closing a Window

1. While viewing a web page in the browser, press  **Menu**.
2. Tap **[Windows]**.
3. Tap  in the row of the window you want to close.

Setting the Home Page

You can set which web page is displayed when you open a new window.

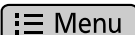
1. On the Application screen, tap .
2. Press  **Menu**.
3. Tap **[More]**.
4. Tap **[Settings]**.
5. Tap **[Set home page]**.
6. Enter the URL of the web page you want to set as the home page.
7. Tap **[OK]**.

Going Back to the Previous Page

You can return to the web page you were viewing before the current web page.

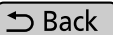
1. While you are viewing a page in Browser, press  **Back**.

Note

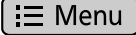
- To display the web page you were viewing before going back a page, press  **Menu**, and then tap **[Forward]**.

Using Browser's Menus

Using the Menu Displayed by Touching and Holding a Link



1. On the Application screen, tap .
2. While viewing a page in Browser, touch and hold a link.
The following actions are available:

Open	Open the link.
Open in new window	Open the link in a new window.
Bookmark link	Bookmark the web page pointed to by the link.
Save link	Save the contents of the music, URL, document, etc. that is pointed to by the link to an SD card.
Share link^{*1}	Send the URL pointed to by the link in an e-mail message.
Copy link URL	Copy the URL pointed to by the link.
Save image	Save the image pointed to by the link to an SD card. This action is available only if the link points to an image file.

View image	Display the image pointed to by the link. This action is available only if the link points to an image file.
-------------------	--

^{*1} This item is displayed only if an e-mail account is configured. (To configure an e-mail account, see page 81.)

Using the Menu Displayed by Pressing the Menu Button

1. On the Application screen, tap .
2. While viewing a page in the web browser, press .

The following actions are available:

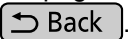
New window	Display a new window.	
Bookmarks	The bookmark screen is displayed where you can add new bookmarks and display bookmarked pages.	
Windows	Display a list of currently open windows.	
Stop	Stop loading the web page. This action is available only while a page is loading.	
Refresh	Reload the information for the current web page. This action is available only after a web page has finished loading.	
Forward	Go forward one page when you are viewing a page displayed by pressing  .	
More	Add bookmark	Add a bookmark for the current web page.
	Find on page	Search for text within the current web page.
	Select text	Select and copy text on the current web page.
	Page info	Display information about the current web page.
	Share page^{*1}	Send the URL of the current web page in an e-mail message.
	Downloads	View a list of files (images, music, URLs, documents, etc.) you downloaded from web sites using the [Save link] or [Save image] commands.
	Settings	Configure settings such as text size and security.

^{*1} This item is displayed only if an e-mail account is set up. (To set up an e-mail account, see page 81.)

Calculator

You can use the calculator application to perform mathematic calculations.

1. On the Application screen, tap .

Note

- Touching and holding in the calculation field shows editing options such as **[Select text]**, **[Copy all]**, and **[Paste]**.
- Tapping **[CLEAR]** deletes the character in front of the cursor.
Touching and holding **[CLEAR]** deletes the entire calculation.

Using Calculator's Menu

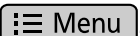
1. On the Application screen, tap .
2. Press  Menu.

The following actions are available:



Clear history	Delete the calculation history.
Advanced panel	Switch from the basic arithmetic pad to the advanced function pad.
Basic panel	Switch from the advanced function pad to the basic arithmetic pad.

Calendar

You can add and manage events.



Events that you have registered are displayed in the Schedule display on the Phone screen (Page 35). When a notification set for an event is activated,  is displayed in the status bar.

Displaying Calendar

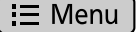

1. On the Application screen, tap .
2. Press .
3. Tap **[Day]**, **[Week]**, **[Month]**, or **[Agenda]** to change the view.

Note

- Pressing  and then tapping **[Today]** allows you to quickly change the view to display today.
- Tapping a day in Month view displays either Day view or Agenda view, depending on whichever was displayed more recently.
- If Google account synchronization is enabled, tapping **[More]** → **[Calendars]** after step 2 displays the Google account you are synchronizing with. You can switch whether to display and synchronize the calendar by tapping the account:

	Synchronize the calendar and display the synchronized calendar's events.
	Synchronize the calendar but do not display the synchronized calendar's events.
	Do not synchronize the calendar and do not display events from the Google account's calendar.



Adding an Event

1. On the Application screen, tap .
2. Press .
3. Tap **[More]**.
4. Tap **[New event]**.
5. Enter a name, the date and time, the location, details, etc. for the event.
6. In **[Reminders]**, select how long before the start of the event you want to be notified of the event.
7. Tap **[Done]**.



Note

- In step 6, tapping  allows you to add additional reminders.
- For details about entering characters, see page 25.
- If you synchronize your calendar with a Google account (Page 128), existing events and any events you add will be added to the Google account.

Checking an Event

1. On the Application screen, tap .
2. Press .
3. Tap **[Day]**, **[Week]**, **[Month]** or **[Agenda]** to change the view.
4. Tap the event you want to check.

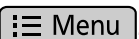

Editing an Event

1. On the Application screen, tap .
2. Press .
3. Tap **[Day]**, **[Week]**, **[Month]** or **[Agenda]** to change the view.
4. Tap the event you want to edit.
5. Press .
6. Tap **[Edit event]**.
7. Enter the new information as necessary, and then tap **[Done]**.

Note

- For details about entering text, see page 25.

Deleting an Event

1. On the Application screen, tap .
2. Tap .
3. Tap **[Day]**, **[Week]**, **[Month]** or **[Agenda]** to change the view.
4. Tap the event you want to delete.
5. Tap .
6. Tap **[Delete event]**.
7. Tap **[OK]**.

Note

- If Google account synchronization is enabled, deleting events on the unit also deletes them from the Google account.

Canceling a Notification/Activating Snooze

When a notification is set for an event,  is displayed in the status bar on the specified date and time.



Follow the procedure below to cancel the notification or to activate snooze.

1. Tap the status bar.
2. Tap the notification.
3. Tap either **[Dismiss all]** or **[Snooze all]**.

Dismiss all	Cancels the notifications of all events.
Snooze all	The notifications of all events will be reactivated after 5 minutes.

Configuring Calendar's Settings

1. On the Application screen, tap .
2. Press  Menu.
3. Tap **[More]**.
4. Tap **[Settings]**.
5. Configure the settings as necessary.

<p>Set alerts & notifications</p>	<p>Select the notification method.</p> <p>Alert: At the specified date and time,  is displayed in the status bar, and the Notification screen is also displayed. If a notification ringtone is set, it is played.</p> <p>Status bar notification: At the specified date and time,  is displayed in the status bar. If a notification ringtone is set, it is played.</p> <p>Off: Notifications are not performed.</p>
<p>Select notification sound</p>	<p>Select the ringtone to be played when a notification occurs.</p>
<p>Default reminder time</p>	<p>Specify the number of minutes notifications should occur before the beginning of an event.</p>

Email

You can compose e-mail messages. You can also attach photos to messages.



Setting Up an E-mail Account

1. On the Application screen, tap .
2. Enter an e-mail address and its associated password.
3. Tap **[Next]**.
4. Following the on-screen instructions, configure the settings.

Note

- For details about entering text, see page 25.

Creating and Sending a New E-mail Message

1. On the Application screen, tap .
2. Press  **Menu**.
3. Tap **[Compose]**.
4. Enter the recipient, subject, and body.
5. Tap **[Send]**.

Note

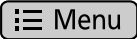
- You can create an e-mail message from the Contacts screen. On the Contacts screen, select the contact you want to send the e-mail to, and then tap the e-mail address. When the message composition screen is displayed, follow steps 4 and 5 above. It is also possible to search for an e-mail address using the contact search box (Page 60).
- Entering the first few characters of an e-mail address in the recipient field displays e-mail addresses registered in your contacts that match the entered text.
- Tapping the icon next to the To, Cc, or Bcc fields lets you select an address from your contacts.
- If you have configured multiple accounts and you want to send an e-mail from an account other than your default account, select an account after step 1.
- To add a Cc or Bcc field, in step 4 press , and then tap **[Add Cc/Bcc]**.
- To attach a file, in step 4 press , tap **[Add attachment]**, and then select a file. The only files you can attach are image files (JPEG, GIF, PNG, BMP). Use the Music application to attach an audio file (Page 88), and use Contacts to attach contact information (Page 62). The maximum size of a file you can send or receive as an attachment is 5 MB.
- Use only half-width alphanumeric characters in the file names of files you attach to e-mail messages. Using other characters (such as full-width characters used in Japanese) may result in the file names becoming garbled.
- For details about entering text, see page 25.

Notice

- Do not attach copyright-protected graphic files to e-mail messages if you do not hold the copyrights to those files.

Reading E-mail

1. On the Application screen, tap .
2. Tap the e-mail message you want to read.

Note

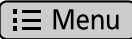
- If you have configured multiple accounts, select an account after step 1.
- To manually receive e-mail, tap **[Load more messages]**.
- You can tap  to mark a message as starred. You can view a list of starred messages by pressing  while viewing your inbox, and then tapping **[Accounts]** → **[Starred]** (Page 83).

Using the Menu while Viewing a Message

While viewing an e-mail message, tapping  displays the following actions:

Delete	Move the current e-mail message to the trash.
Forward	Forward the current e-mail message.
Reply	Reply to the current e-mail message.
Reply all	Reply to the sender and all recipients of the current e-mail message other than yourself.
Mark as unread	Mark the current e-mail message as unread.

Viewing an Attachment

1. On the Application screen, tap .
2. Tap the e-mail message you want to read.
3. Tap **[Open]**, located next to the attachment.

Saving an Attachment to an SD Card

You can save attachments in received messages to an SD card.

1. On the Application screen, tap .
2. Tap the e-mail message you want to read.
3. Tap **[Save]**, located next to the attachment.

Note

- When the file has been saved, the message **[Attachment saved to SD card as "****.***"]** is displayed.

Forwarding an E-mail Message

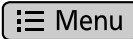

1. On the Application screen, tap .
2. Tap the e-mail message you want to forward.
3. Press , and then tap **[Forward]**.
4. Enter the address you want to forward the message to.
5. Tap **[Send]**.

Note

- Attachments cannot be forwarded. When forwarding an e-mail message that has an attachment, first save the attachment to an SD card, and then attach it in step 4 to the message you are forwarding. (For details about saving an attachment to an SD card, see page 82. For details about attaching a file to an e-mail message, see page 81.)

Displaying a List of Folders

You can display and view the contents of folders such as your inbox, sent messages, drafts, etc.

1. On the Application screen, tap .
2. Press .
3. Tap **[Folders]**.

Note

- If you have configured multiple accounts, you must select an account after step 1.

Deleting All Messages in the Trash

IMPORTANT

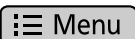
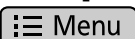

- Deleting all messages from the trash permanently removes them from the unit. This action cannot be undone.

1. On the Application screen, tap .
2. Press .
3. Tap **[Folders]**.
4. Press .
5. Tap **[Empty trash]**.
6. Tap **[OK]**.

Note

- If you have configured multiple accounts, you must select an account after step 1.

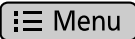

Adding an Account

1. On the Application screen, tap .
2. Press .
3. Tap **[Accounts]**.
4. Press .
5. Tap **[Add account]**.
6. Enter an e-mail address and its associated password.
7. Tap **[Next]**.
8. Follow the on-screen instructions.

Note

- If you have configured multiple accounts, steps 2 to 3 are unnecessary.
- For details about entering text, see page 25.



Deleting an Account

1. On the Application screen, tap .
2. Press  Menu.
3. Tap **[Accounts]**.
4. Touch and hold the account you want to delete.
5. Tap **[Remove account]**.
6. Tap **[OK]**.

Note

- If you have configured multiple accounts, steps 2 to 3 are unnecessary.

Changing Account Settings

1. On the Application screen, tap .
2. Press  Menu.
3. Tap **[Accounts]**.
4. Touch and hold the account you want to change.
5. Tap **[Account settings]**.

You can change the following settings:

Account name	Change the account name.
Your name	Change the sender name.
Signature	Enter some text to append to the end of e-mail messages, such as your name.
Email check frequency	Specify whether to automatically check for new messages. Also, if you enable automatic checking, specify the frequency at which to check.
Default account	Set this account as the preferred account.
Email notifications	Select whether to display a notification in the status bar when a new message arrives.
Select ringtone	If you enabled [Email notifications] , select the ringtone to play when a new message arrives. This ringtone has a higher precedence than the one specified for [Notification ringtone] (Page 117).
Incoming settings	Configure the incoming mail server settings.
Outgoing settings	Configure the outgoing mail server settings.

Note

- If you have configured multiple accounts, steps 2 to 3 are unnecessary.

Gallery







You can display and edit (rotate, crop, delete) images saved on an SD card.

Displaying an Image

1. On the Application screen, tap .
2. Select an image folder.
3. Tap the image you want to view.

Icons Displayed while Viewing an Image

You can perform the following operations by using the icons that are displayed while you are viewing an image.

	Delete the current image.
	Display the previous image in the image folder.
	Display the next image in the image folder.
	Zoom in on () and out of () the current image.

Viewing Images as a Slideshow

1. On the Application screen, tap .
2. Touch and hold the folder that contains the images you want to view as a slideshow.
3. Tap **[Slideshow]**.



Note

- Tapping the display during a slideshow ends the slideshow.

Deleting an Image

IMPORTANT

- Deleted images cannot be restored from the trash.

1. On the Application screen, tap .
2. Select an image folder.
3. Tap the image you want to delete.
4. Tap .
5. Tap **[OK]**.

Using Gallery's Menu

When you press  Menu while viewing an image, the following actions are available.

Image Folder View

Settings	Configure various settings, such as the display size for thumbnail images and slideshow settings.
-----------------	---

Thumbnail View

Slideshow	Play a slideshow.
Multiselect	Select multiple images, which you can then delete.
Settings	Configure various settings, such as the display size for thumbnail images and slideshow settings.

Single Image View

Rotate	Rotate the current image to the right or to the left.
Delete	Delete the current image.
Crop	Crop the current image.
Details	Display details about the current image.
Slideshow	Begin a slideshow starting with the current image.
Settings	Configure various settings, such as the display size for thumbnail images and slideshow settings.

Music

You can play music that was attached to an e-mail message or is saved on an SD card.

Playing Music







1. On the Application screen, tap .
2. Select the **[Artists]**, **[Albums]**, **[Songs]**, or **[Playlists]** tab.
3. Select an item as necessary, and then tap the song you want to play.

Note

- If you receive or make a call while music is playing, the music will stop automatically.
- If you start playing music during a call, normally the other party will not be able to hear it. However, if the playback volume is loud, sound from the speaker can be picked up by the microphone, and the other party may be able to hear the music.

Icons Displayed while Playing Music

You can perform the following operations by using the icons that are displayed while you are playing music.

	Display the songs in the current playback list.
	Shuffle the songs in the current playback list.
	Loop playback. Tapping this button cycles through the loop modes as follows: [Repeating all songs.] → [Repeating current song.] → [Repeat is off.]
	Skip to the previous song in the playback list. This button will also return you to the start of the current song.
	Pause the current song. When a song is paused, tapping  resumes playing it.
	Skip to the next song in the playback list.

Pausing the Current Song

If you are viewing another screen while playing music, you can pause the music from the status bar.

1. Tap the status bar.
2. Tap the song on the notification screen.
3. Tap .

Making a Playlist

You can organize songs you like by creating playlists.

1. On the Application screen, tap .
2. Select the **[Artists]**, **[Albums]**, **[Songs]**, **[Playlists]**, or **[Now playing]** tab.

3. Select an item as necessary, and then touch and hold a song you want to add to a playlist.
4. Tap **[Add to playlist]**.
5. Select the playlist you want to add the song to.

Note

- If you select **[New]** in step 5, enter a name for the playlist.

Editing a Playlist

1. On the Application screen, tap .
2. Tap the **[Playlists]** tab.
3. Touch and hold the playlist you want to edit.
The following actions are available:

Play	Begin playing the selected playlist.
Delete	Delete the selected playlist.
Rename	Change the name of the selected playlist.
Edit	Set the period for which items are displayed in [Recently added] .

Note

- If the only available playlist is **[Recently added]**, then some actions will not be available.

Search for Related Content in Browser



A search will be performed in Browser based on the selected song's artist, album, and title.

1. On the Application screen, tap .
2. Select the **[Artists]**, **[Albums]**, **[Songs]**, **[Playlists]**, or **[Now playing]** tab.
3. Touch and hold a song title or item as necessary.
4. Tap **[Search]**.
5. Tap **[Browser]**.

Note

- If you selected **[Now playing]** in step 2, step 4 is omitted.

Using the Music Application's Menu

1. On the Application screen, tap .
2. Select the **[Artists]**, **[Albums]**, **[Songs]**, **[Playlists]**, or **[Now playing]** tab.
3. Press .

The following actions are available:

Play all	Play the songs in the selected list.
Party shuffle	A list will be created from the songs on the SD card, and the songs will be played in a random order. You may change the order of songs, and add and remove songs as you like.

Shuffle all	Play through all the songs on the SD card in a random order.
Library	Display the screen that was displayed before you started playing music.
Add to playlist	Add the selected song to a playlist.
Set to ringtone list	Add the selected song as a selection for incoming ringtones (Page 98).
Delete	Delete the selected song.
Share	Send the currently playing song as an attachment to an e-mail message.

Note

- Depending on the selected tab, some actions may not be available.
- While playing a party shuffle, tapping  on the **[Now playing]** tab lets you change the order of songs in the list, remove songs, etc.

Notice

- Do not attach copyright-protected music files to e-mail messages if you do not hold the copyrights to those files.

Advanced Settings

Forward/Do Not Disturb

Enabling Do Not Disturb (DND) prevents incoming calls from ringing at your unit when you are away from your seat or otherwise unavailable to answer calls.

Forwarding allows you to have incoming calls forwarded to a specified destination when you are away from your seat.

1. Tap the status bar.
2. Tap [**Forward/DND**].
3. Select the setting to configure.

All

Forward all calls.

If you select this setting, you must also specify the number to forward calls to.

Busy

Forward calls that arrive while you are on a call.

If you enable this setting, you must also specify the number to forward calls to.

No Answer

Forward calls after you do not answer for a specified length of time.

If you enable this setting, you must also specify the number to forward calls to and the number of times the unit rings before the call is forwarded.

Do Not Disturb

Prevent calls from ringing at your unit.

4. When you have finished, tap [**OK**].

Note

- FWD/DND can be enabled only when the unit is idle or during pre-dialing.
- If multiple lines are configured on your unit, select the tab of the line to configure after step 2.
- You can enable multiple settings simultaneously.
If multiple settings are enabled, the priority of the settings is as follows:
 1. Call Block, Block Anonymous Call
 2. All
 3. Do Not Disturb
 4. Busy
 5. No Answer
- You cannot enable FWD/DND on a shared line.

Canceling FWD/DND

1. Tap the status bar.
2. Tap [**Forward/DND**].
3. Deselect the check box.
4. Tap [**OK**].

Automatic Answer

Enabling Automatic Answer allows you to answer calls without having to manually go off-hook. This feature is useful when you use a headset.

1. Tap the status bar.
2. Tap **[Auto Answer]**.
3. Tap **[Enable]**.

Note

- Automatic Answer can be enabled only when the unit is idle or during pre-dialing.
- With Automatic Answer enabled, the unit will automatically answer calls only while it is idle or during pre-dialing.

Canceling Automatic Answer

1. Tap the status bar.
2. Tap **[Auto Answer]**.
3. Tap **[Disable]**.

Customizing Flexible Buttons

You can assign applications or telephone functions you frequently use to flexible buttons.

Doing so allows you to access these items with one touch and avoid multi-step procedures.

You can assign the following items to flexible buttons:

Phone function

Assign functions for making and handling phone calls to the flexible button. For details about the different types of phone functions, see page 92.

Applications

Assign an application to a flexible button. Tapping the flexible button will start the specified application.

Bookmark

Assign a web page's URL to the flexible button. Tapping the flexible button will start Browser and then load the page at the specified URL.



Network Cameras

Assign a network camera to a flexible button. Tapping the flexible button allows you to view the video feed from the specified network camera.

Note

- Some flexible buttons may already have phone functions assigned to them through configuration file programming. These buttons cannot be modified. For details, consult your administrator or dealer.
- If a phone function is assigned through configuration file programming to a button to which an application, bookmark, or network camera had previously been assigned, the phone function will override the previous setting. For details, consult your administrator or dealer.

Assigning a Function to a Flexible Button

1. On the Phone screen, tap .
2. Press  **Menu**.
3. Tap **[Start Flexible Button Prog Mode]**.
4. Tap the desired key.
5. On the **[Select]** screen, select the function you want to assign.
6. Follow the on-screen instructions.

Note

- During steps 4 to 6, if you do not perform any operations for 1 minute the unit returns to full-screen display.
- The name and icon of the flexible button will change according to the function assigned to it.
- For details about entering text, see page 25.

Removing the Function Assigned to a Flexible Button

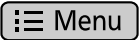
1. On the Phone screen, tap .
2. Press  Menu.
3. Tap [Start Flexible Button Prog Mode].
4. Tap the flexible button whose function you want to remove.
5. On the [Select] screen, tap [Clear].

Note

- During steps 4 to 5, if you do not perform any operations for 1 minute, the unit will return to full-screen display.

Phone Function Types

The following phone functions can be assigned to flexible buttons.
When assigning a phone function, you must specify the following three settings:

Type

The type of phone function to assign to the flexible button (DN, One-touch, Headset, BLF).

Parameter

Specify the settings necessary for the type of phone function.

Label name

Enter the label to display on the flexible button.

DN

Seizes the line assigned to the key, and also shows the status of the line.
Tapping a flexible button set as a DN (Directory Number) button answers calls arriving at that button, retrieves calls held at that button, etc.

Color (State)	Line Status
Off	Idle
Green (steady on)	Dialing/On a call

Color (State)	Line Status
Green (flashing rapidly)	Incoming call
Green (flashing slowly)	Call on hold
Red (steady on)	For a shared line, in use or has a call on private hold by another unit
Red (flashing slowly)	For a shared line, has a call on hold by another unit

Parameter

- **Ringtone:** Select the ringtone to play when a call arrives at this button. If a ringtone is already specified for the line through phone settings (Page 116), this option is unavailable.
- **Phone Number:** If multiple lines are configured on your unit, select the line to associate this DN button with. If only one line is configured, this setting is unavailable. For details, consult your administrator or dealer.

Note

- If a call is on private hold (red, steady on), the call cannot be retrieved except from the unit that put the call on hold.

One-Touch

Dials the number assigned to the button.

Parameter

Enter the number to dial when this button is tapped (max. 32 characters).

Headset

Switches headset mode on or off.

Color (State)	Headset Mode
Off	Off
Red (steady on)	On

Parameter

None

BLF

Shows the status of another local phone's line. You can use a flexible button set as a BLF (Busy Lamp Field) button to call or transfer a call to the phone assigned to the button.

When a call arrives at the phone assigned to a BLF button, tapping the button allows you to answer the call instead of the original recipient. (This feature requires the Direct Call Pickup setting to be specified. For details, consult your administrator or dealer.)

Color (State)	Line Status
Off	Idle
Red (steady on)	On a call
Red (flashing)	Incoming call

Parameter

Enter the number of the local phone to monitor (max. 32 characters).

Using a Headset

To use a headset, you must enable headset mode.

Enabling Headset Mode

1. Tap the status bar.
2. Tap **[Headset mode]**.
3. Tap **[On]**.

Note

- You can also use a flexible button set as a headset button to switch **[Headset mode]**. For details about configuring flexible buttons, see page 91.
- For details about connecting a headset, see page 104.



Disabling Headset Mode

1. Tap the status bar.
2. Tap **[Headset mode]**.
3. Tap **[Off]**.

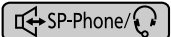
Making a Call Using a Headset

1. Press .
2. Enter a phone number.
3. To end the call, press .

Receiving a Call Using a Headset

1. Press .
2. To end the call, press .

Activating the Screen Lock

When you activate the screen lock, you can lock access to normal phone functions and to applications. This feature is useful for preventing unwanted use of the unit while you are away from your seat.

Phone numbers set beforehand as emergency numbers can still be dialed, and calls can still be received.

Notice

- If an unlock pattern, PIN, or password has not been set, the screen lock cannot be activated, so be sure to set one beforehand (Page 118).

1. Tap **[Screen lock now]** in the application dock.
 - The screen lock will be activated and the screen saver will start.

Note

- To dial an emergency number, see page 52.

Unlocking the Screen Lock

1. Touch the display or key sheet, or press an alphanumeric or symbol key on an attached USB keyboard.
Or, lift the handset off its cradle.
2. Trace the unlock pattern, enter the PIN, or enter the password.

Note

- The lock is activated according to the method you selected for **[Set up screen lock]** in the **[Security]** settings (Page 118).
- If you selected **[Pattern]** in the lock settings, trace the unlock pattern in a single stroke without lifting your finger off the display.
- If the unlock pattern, PIN, or password is input incorrectly 5 times in a row, a message will be displayed, and you will not be able to unlock the unit for 30 seconds.

Customizing the Phone

Changing the Wallpaper

You can change the wallpaper (background image) of the Home screen and the Phone screen.

Changing the Home Screen Wallpaper

1. On the Home screen, press  **Menu**.
2. Tap **[Wallpaper]**.
3. Select the image to set as the wallpaper.

Select built-in wallpaper

Select from images included on the unit.

Select wallpaper from Gallery

Select from images saved on an SD card.

4. Do one of the following, depending on your selection:

Select built-in wallpaper

Tap **[Set wallpaper]**.

Select wallpaper from Gallery

Move the border and change the crop size as necessary, and then tap **[Save]**.

Note

- The size of the wallpaper is 800 × 455 pixels. On the Home screen, the wallpaper will be displayed in the area indicated by the dotted line in the following figure:

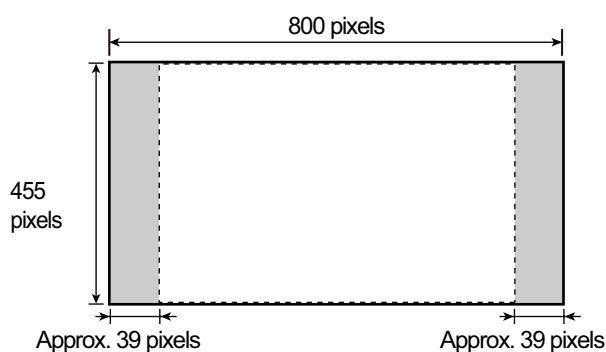

- For the Home screen wallpaper, make an image that is 800 × 455 pixels, and then resize it to 640 × 480 pixels using an image editor. If you try to use the image without resizing it, it may not be displayed correctly.

- The following file formats can be used for the Home screen wallpaper: JPEG, BMP, GIF, PNG.
- Depending on configuration file programming, you may not be able to change the wallpaper. For details, consult your system administrator or dealer.

Changing the Phone Screen Wallpaper

1. On the Phone screen, touch and hold the wallpaper area in the upper left of the display.



2. Select the image to set as the wallpaper.

Select wallpaper from Gallery

Select from images saved on an SD card.

Select built-in wallpaper

Select from images included on the unit.

Bright screen

Change the color of the wallpaper and dial keys to a bright color.

Dark screen

Change the color of the wallpaper and dial keys to a dark color.

Note

- For the Phone screen wallpaper, use an image that is 800 × 455 pixels. To place your logo on the wallpaper, refer to the following figure:

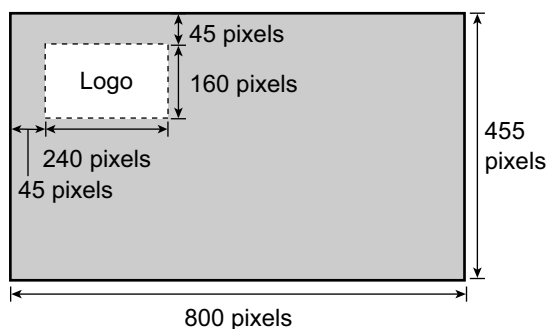

- The following file formats can be used for the Phone screen wallpaper: JPEG, GIF, PNG.
- Depending on configuration file programming, you may not be able to change the wallpaper. For details, consult your system administrator or dealer.

Adding and Deleting Shortcuts, Widgets and Folders

You can add widgets and shortcuts to applications to the Home screen and place frequently used applications in the application dock.

The following shortcuts, widgets and folders can be added.

Shortcuts

- Applications (Page 71)
- Bookmarks
- Contact
- Direct dial
- Email
- Music playlist
 - Play all
 - Recently added
- Settings
 - Cleaning mode
 - Screen lock now

Widgets

- Analog clock
- Calendar
- Music
- Picture frame
- Search

Folders

- New folder
- All contacts
- Contacts with phone numbers
- Starred contacts

Adding a Shortcut, Widget or Folder

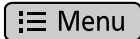
1. On the Home screen, press  **Menu**, and then tap **[Add]**.
Or, touch and hold on the Home screen a spot with no icons.
2. Select **[Shortcuts]**, **[Widgets]**, or **[Folders]**.
3. Tap the item you want to add.

Moving a Shortcut, Widget or Folder

1. On the Home screen, touch and hold a shortcut, widget or folder, and then drag it to the spot you want to move it to.

Deleting a Shortcut, Widget or Folder

1. On the Home screen, touch and hold the shortcut, widget or folder you want to delete.
2. Drag the item to .

Adding to the Application Dock

1. On the Application screen, touch and hold the application you want to add.
2. Drag the item to the spot in the application dock you want to place it.

Note

- Up to 7 applications can be added.
- Widgets and folders cannot be added to the application dock.

Displaying Your Schedule on the Phone Screen

On the Phone screen, you can change the area where the dial keys are displayed to display your schedule instead.

1. On the Phone screen, press  **Menu**.
2. On the **[Menu]** screen, tap **[Phone screen setting]**.
3. Tap **[Schedule]**.

Note

- Initially, the unit is set to display the dial keys.
- To return the display to the dial keys, select **[Dial]** in step 3.
- The Schedule/Dial Key display can also be changed temporarily (Page 36).

Setting a Ringtone

You can change the ringtone that plays when the unit receives a call.

1. On the Home screen, press .
2. Tap **[Settings]**.
3. Tap **[Sound]**.
4. Tap **[Phone ringtone]**.
5. Select a ringtone.
6. Tap **[OK]**.

Note



- If multiple lines are configured on your unit, you can set a different ringtone for each line.
- In step 5, if you select **[Automatic]**, the ringtone assigned to the DN button (flexible button) at which a call arrives will be used. Ringtones specified here override the DN button settings (Page 92).
- Even if the ringer volume is off, you can still select and listen to the available ringtones.
- You can also select from music on an SD card. To select a ringtone from an SD card, you must configure some settings beforehand (Page 98).
- For music on an SD card, "(SD)" is displayed in front of the title.
- When a music file on the SD card is set as the ringtone and you remove the SD card, "Ringtone 1" will be used as the ringtone. If you reinsert the SD card, the file you had previously specified will be used again as the ringtone.

Using Music on an SD Card as the Ringtone

You can use music on an SD card as the ringtone.

Notice

- Do not remove the SD card while performing the following procedure.

1. On the Home screen, tap .
2. Tap the **[Songs]** tab.
3. Touch and hold the title of the song you want to set as the ringtone.
4. Tap **[Set to ringtone list]**.
5. Press  to return to the Home screen.
6. On the Home screen, press .
7. Tap **[Settings]**.
8. Tap **[Sound]**.
9. Tap **[Melody for phone ringtone]**.
10. Select the ringtone you want to change, and then tap **[Change]**.
11. On the **[Ringtone List (Music on SD)]** screen, select the file you want to add as the ringtone.
12. Tap **[OK]**.
13. On the **[Melody for phone ringtone]** screen, tap **[Cancel]**.

Note

- Ringtones you add are stored in ringtones 10 to 32, overwriting the factory default ringtone.
- The following music file formats are supported by this unit:
 - 3GPP (.3gp)
 - MPEG-4 (.mp4, .m4a)
 - MP3 (.mp3)
 - MIDI (.mid)
 - RTTTL/RTX (.rtttl)
 - iMelody (.imy)
 - Ogg (.ogg)
 - WAVE (.wav)
- For details about setting a ringtone, see page 98.
- For details about setting a ringtone for an individual contact, see page 63.

Resetting Ringtones to Their Factory Settings

1. On the Home screen, press .
2. Tap **[Settings]**.

3. Tap **[Sound]**.
4. Tap **[Melody for phone ringtone]**.
5. Select the ringtones you want to reset to their factory settings, and then tap **[Reset to default]**.

Web User Interface Programming

The unit provides a Web-based interface for configuring various settings and features, including some that are not programmable directly from the unit. The following list contains some useful features that are programmable through the Web user interface.

For details, consult your administrator or dealer.

- Basic network settings^{*1} (Page 115)
- User password (for access to Web user interface)
- HTTP authentication settings
- Default outgoing line
- Call rejection phone numbers^{*1} (Page 53)
- Block caller ID
- Block anonymous calls
- Do Not Disturb^{*1} (Page 90)
- Call forward^{*1} (Page 90)

^{*1} These settings can also be configured directly through the unit.

Notice











- Each time you want to access the Web user interface, you must enable Web programming (Page 116).

Accessibility

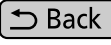
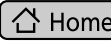
For users with difficulties operating the touch display directly, this unit supports navigation of the interface and operation of phone functions with a USB keyboard. Most navigation features are available simply by connecting a USB keyboard. However, by enabling Accessibility mode (Page 124), more functions can be accessed directly with the keyboard.

Keyboard Operation

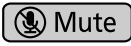
Navigation of the user interface is done primarily with the arrow keys ([↑], [↓], [←] and [→]) and the [Enter] key. The following table shows the functions of other keys, both when Accessibility mode is on and off:

Key	Accessibility Mode On	Accessibility Mode Off	Key Sheet Equivalent
[↑], [↓], [←], [→]	Moves the cursor/highlight up, down, left or right.		   
[Enter]	Performs the action equivalent to tapping the highlighted item.		
[Esc]	On the Phone screen <ul style="list-style-type: none"> During pre-dialing: Equivalent to tapping [Cancel]. Ignored otherwise. On other screens/applications <ul style="list-style-type: none"> Navigates back one screen. 	Navigates back one screen.	
[Home]	Returns to the Home screen.		
[End]	Ends the current call if you are using the handset. (This operation does not end calls in hands-free mode.)		—
Application key	Moves the cursor to the quick-search box. On the Contacts screen, the cursor is moved to the Contact search box (Page 60).		—
[F1]	Volume up.	Opens the menu.	
[F2]	Volume down.	(no function)	
[F3]	Activates the speakerphone or headset mode (Page 24).		
[F4]	Cancels the speakerphone or headset mode (Page 24).		
[F5]	Activates Mute (Page 56). When you press this key, a confirmation tone (single) is heard.	(no function)	
[F6]	Cancels Mute (Page 56).	(no function)	
[F7]	Enables Automatic Answer (Page 91). When you press this key, a confirmation tone (single) is heard.	(no function)	—

Key	Accessibility Mode On	Accessibility Mode Off	Key Sheet Equivalent
[F8]	Disables Automatic Answer (Page 91). When you press this key, a confirmation tone (double) is heard.	(no function)	—
[F9]	Redial (Page 51).	(no function)	—
[F10]	Accesses voice mail (Page 56).	(no function)	—
[F11]	<ul style="list-style-type: none"> Places the call on hold or retrieves a call on hold (Page 54). If a call arrives while you are on a call, places the current call on hold and answers the incoming call (Page 53). If you are on a call and have a call on hold, swaps the calls. 	(no function)	—
[F12]	<ul style="list-style-type: none"> Begins a transfer operation by placing the current call on consultation hold (Page 55). After you begin a transfer but before the transfer destination answers, cancels the transfer and retrieves the call. After the transfer destination answers, switches between the transfer destination and the call to transfer. 	(no function)	—

Connections and Installation

Notice

Panasonic assumes no responsibility for injuries or property damage resulting from failures arising out of improper installation or operation inconsistent with this documentation.

Attaching the Stand (Adjusting the Angle of the Unit)

The stand can be attached to the unit in two ways in order to change the angle of the unit. Depending on the angle you want to use the unit at, the holes to which you attach the stand differ, so determine your preferred angle before attaching the stand. If you want to change the angle after you have attached the stand, remove the stand (Page 103), and then reattach it at the desired angle.

Attaching the Stand

1. Insert the 4 tabs into the holes on the back of the unit body (either A or B).

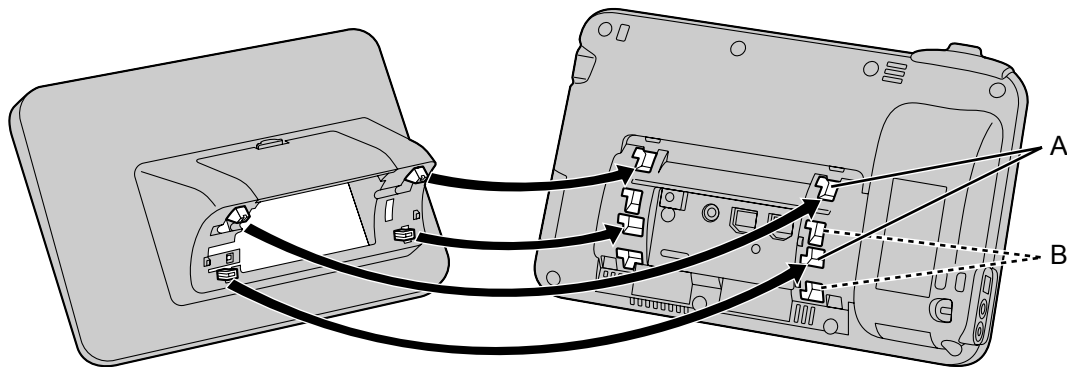

■ For "A"

■ For "B"

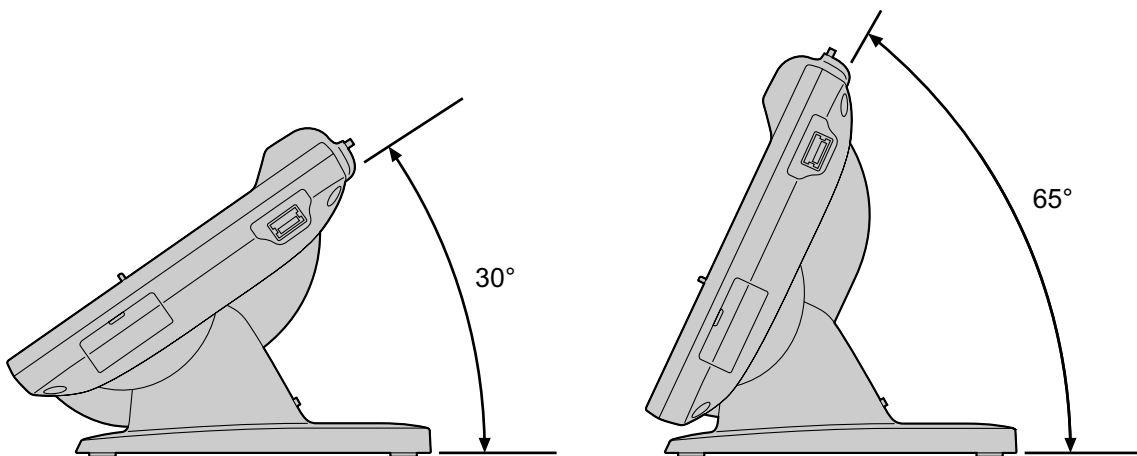

2. To fasten the stand, slide the stand to the left until it clicks.

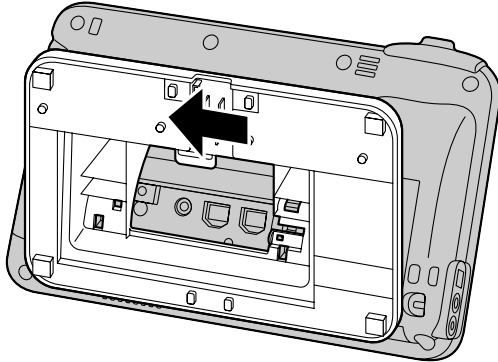
**Notice**

- If you place the display face down when you attach the stand, be sure to place a soft cloth under the display. Failure to do so may result in damage to the display.

Removing the Stand

1. Gently lift up the tab on the back (❶) with your finger, slide the stand to the right, and then remove it.

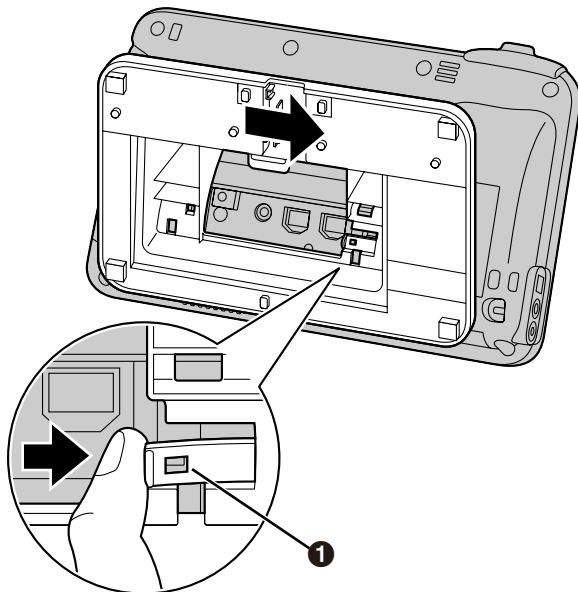
**Notice**

- Do not forcefully lift or pull the tab. Doing so could cause the tab to break.

Connections

Connections for Ethernet Cables, AC Adaptor, Headset

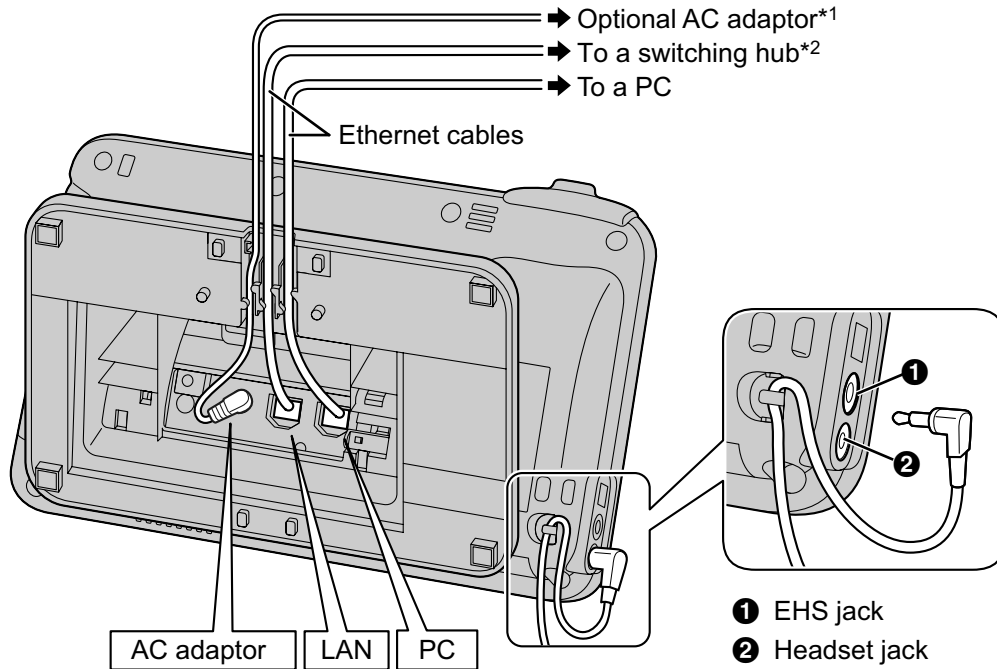

*1 If power is supplied over Ethernet (PoE), an AC adaptor is unnecessary.
*2 To use PoE, use a PoE switching hub that is PoE Class 3 compliant.

When connecting an Ethernet cable

Connect the Ethernet cable as shown in the following figures.

- If the distance from the end of the connector to the bend in the cable is 30 mm (1 ³/₁₆ in) or less

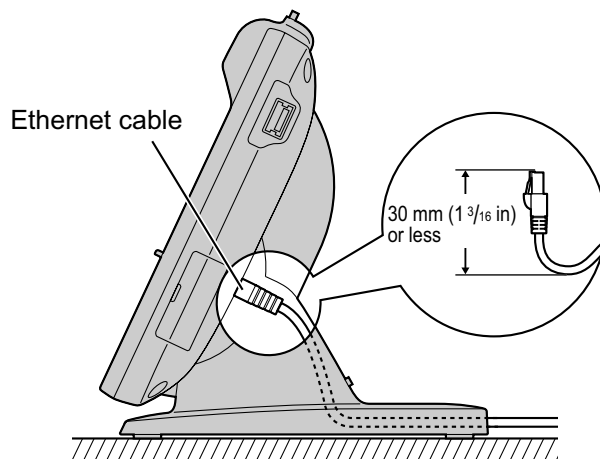

- If the distance from the end of the connector to the bend in the cable is more than 30 mm (1 ³/₁₆ in)
Remove the cable cover (❶) from the back of the stand, and then run the Ethernet cable so the stand lies flat on a horizontal surface.

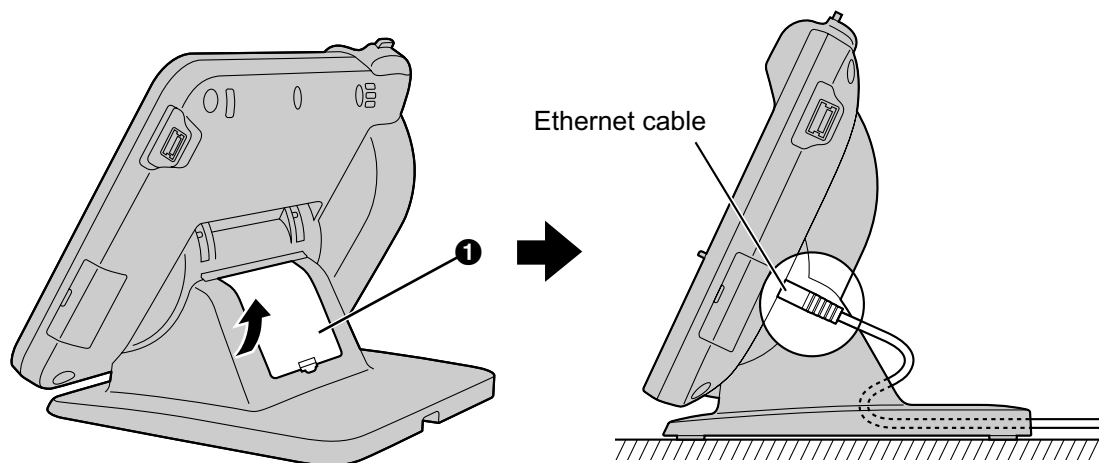

Notice

Optional AC adaptor

- For this Smart Desk Phone, you must use only the Panasonic AC adaptor KX-A422 (PNLV228).
- Ensure that the AC outlet is installed near the unit and is easily accessible.
- Ensure that the AC adaptor cord has slack. Pulling the cord too tightly can result in damage to the connectors.

When connecting a headset

- Ensure that the headset cord has slack. Pulling the cord too tightly can result in damage to the connectors.
- The following headsets can be used with this unit. (Not all operations with the headsets can be guaranteed.)

- Wired headsets:
Panasonic KX-TCA400 or KX-TCA430
- EHS headsets:
Selected Plantronics®-brand headsets

For up-to-date information about headsets that have been tested with this unit, refer to the following web sites:

<http://www.panasonic.com/sip> (for users in the United States)

<http://panasonic.net/pcc/support/sipphone> (for users in Canada)

When selecting Ethernet cables

- Use a straight, category 5e cable (sold separately) that is 6.5 mm ($\frac{1}{4}$ in) in diameter or less.
- Use flexible cables without jack covers. Do not use cables with a hard coating that may tear or crack when bent.
- To prevent damage to the cables, use cables that do not protrude from the bottom of the base.

When connecting a PC

- Only a PC can be connected to the PC port. Other phones, or network devices such as routers or switching hubs, cannot be connected.
- The PC port does not support PoE for connected devices.

Connecting the Handset

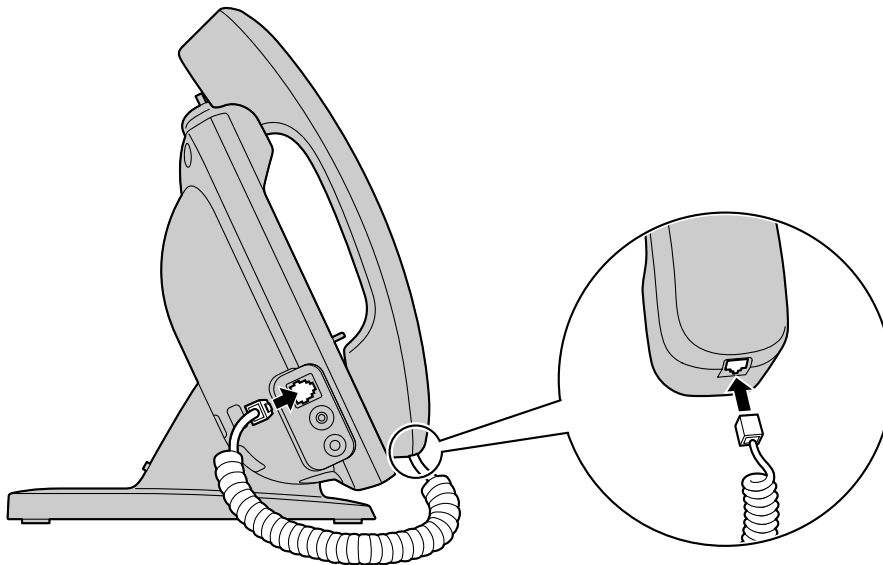

Connecting a USB Keyboard

You can connect a standard USB keyboard (available commercially).

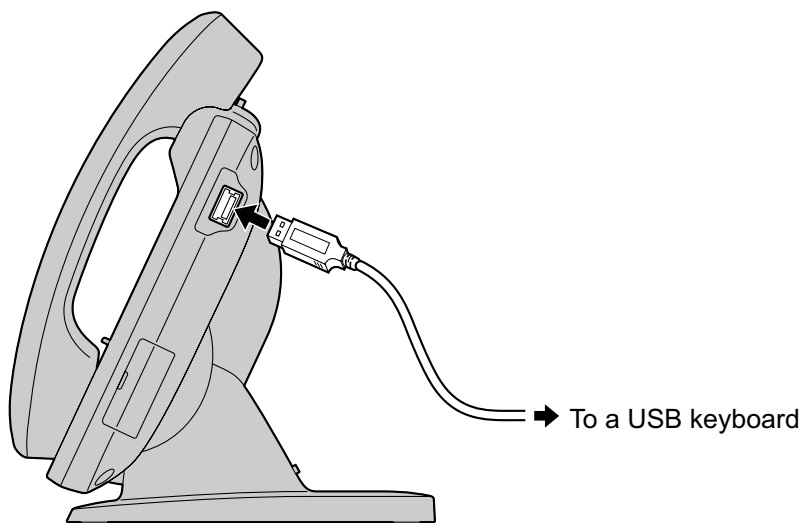

Notice

- Return to the Home screen before connecting or disconnecting a USB keyboard.
- Ensure that the USB cable has slack. Pulling the cord too tightly can result in damage to the connectors.

Note

- Devices other than USB keyboards cannot be connected.
- You may connect a USB hub to the unit, and then connect a USB keyboard to the hub. In this case, you can connect a maximum of 2 hubs in a chain.

Wall Mounting

To mount the unit on a wall, you must purchase the wall mount kit (Page 17).

If the stand is attached, remove it (Page 103).

Carefully read the safety notices regarding wall mounting before mounting the unit on a wall (Page 7).

Notice

- Use only the washers and screws included with the wall mount kit.
- If you place the display face down when you attach the wall mounting adaptor, be sure to place a soft cloth under the display before attaching the adaptor. Failure to do so may result in damage to the display.

1. Insert the 4 tabs of the wall mounting adaptor into the designated openings in the base (①), and then slide the wall mounting adaptor up until it clicks (②).

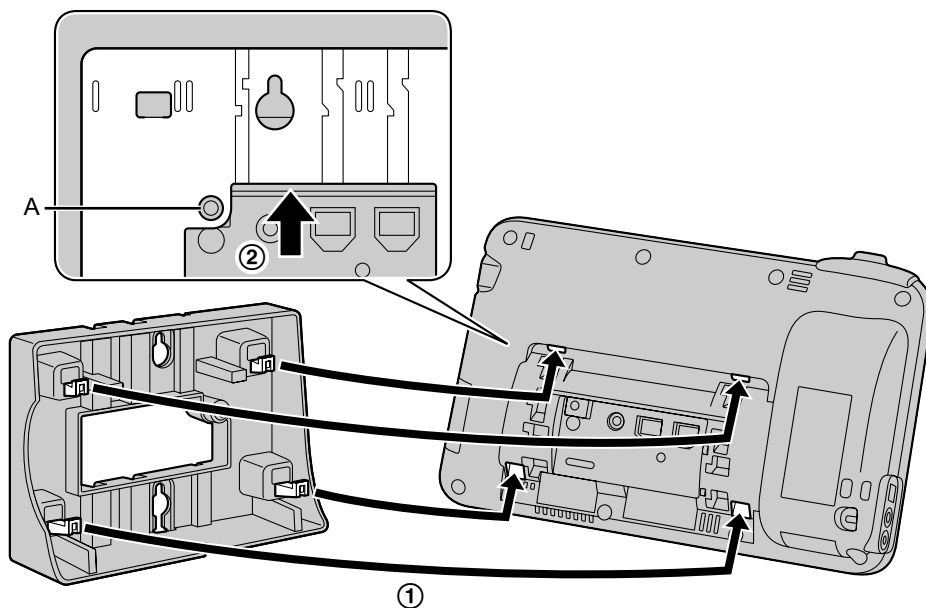

Notice

- Ensure that the screw hole (A) shown in the figure above is accessible through the wall mounting adaptor.

2. Fasten the wall mounting adaptor to the base with the screw for the wall mounting adaptor. (Recommended torque: 0.4 N·m [4.08 kgf-cm/3.54 lbf-in] to 0.6 N·m [6.12 kgf-cm/5.31 lbf-in])

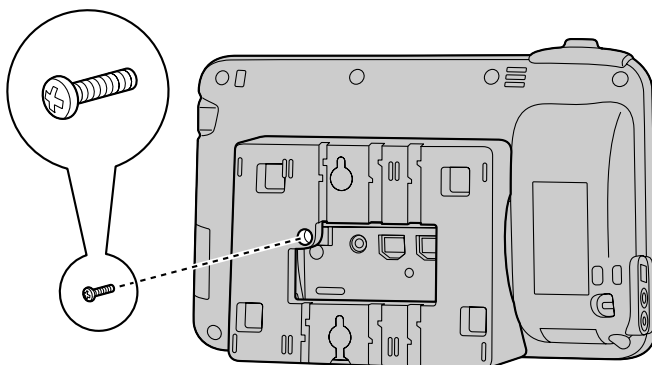

3. Connect the cables to the unit, and run the cables through the wall mounting adaptor, as shown in the illustration below.

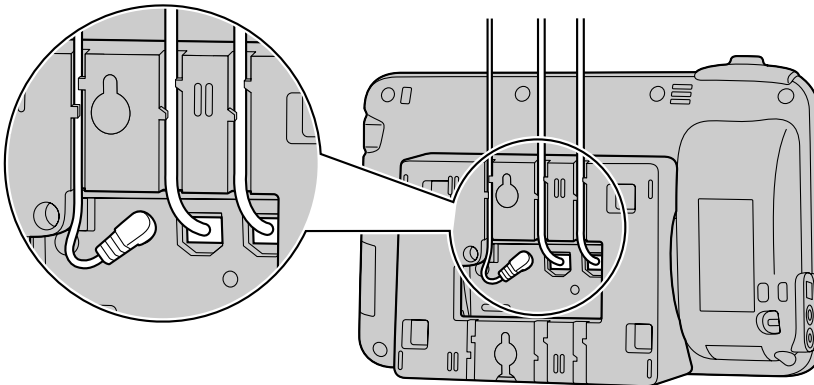

Note

- The cables can also be run from the bottom of the unit.
- For details about connecting the cables, see page 104.

4. Screw the 2 screws for wall attachment with their washers into the wall as shown in the following figure, and then mount the unit on the wall.

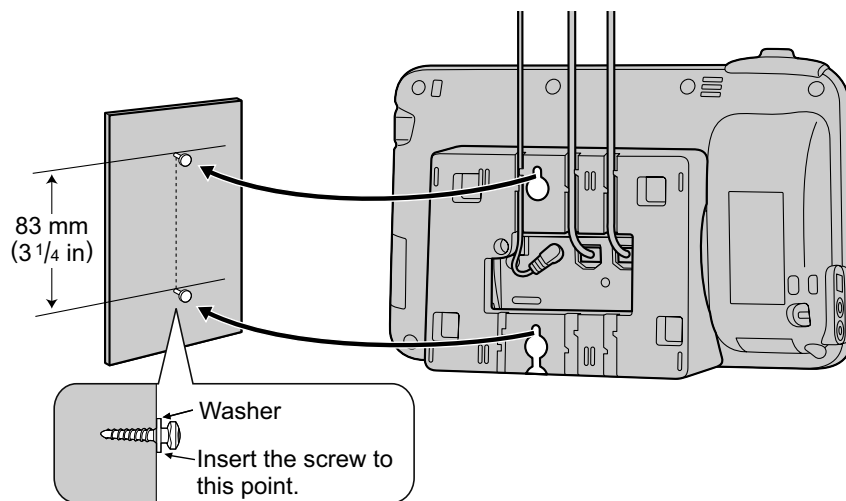

Note

- You can find a wall mounting template at the end of this manual.

5. Remove the handset hook by pushing it firmly upwards.

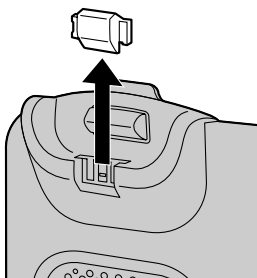

6. Turn the handset hook up-side-down.

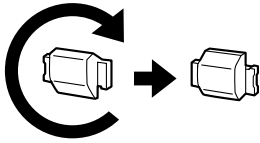

7. Slide the handset hook back into its slot until it clicks.

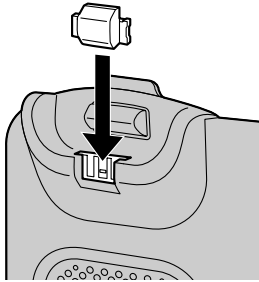

- The handset will be safely hooked when it is in the cradle.

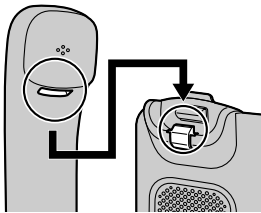

Hooking the Handset During a Conversation

1. Hook the handset over the top edge of the unit.

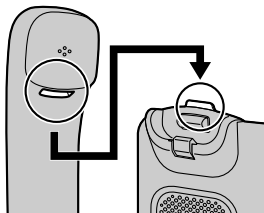

Configuration

You can configure the settings required to connect the unit to the network, as well as other various settings.

Making Settings

1. On the Home Screen, press  **Menu**.
2. Tap **[Settings]**.
3. Navigate to and tap the desired setting.
4. Make changes to the setting as required.

Setting Items

The following items for the unit can be configured.

Main Category	Sub-Category	Setting	Reference
└ Screen lock now			Page 115
└ Network	└ MAC Address		Page 115
	└ Basic Network settings	└ Connection mode	Page 115
		└ DHCP Settings	Page 115
		└ Static Settings	Page 115
	└ Proxy server settings	└ Use proxy server	Page 116
	└ Embedded web		Page 116
	└ Network Test	└ Target address	Page 116
└ Sound	└ Volume	└ Ringtone	Page 116
		└ Media	Page 116
		└ Alarm	Page 116
		└ Use incoming call volume for notifications	Page 116
	└ Phone ringtone		Page 117
	└ Melody for phone ringtone		Page 117
	└ Notification ringtone		Page 117
	└ Audible touch tones		Page 117
	└ Audible selection		Page 117

Main Category	Sub-Category	Setting	Reference
└ Display	└ Brightness		Page 117
		└ Animation	Page 117
		└ Screen timeout	Page 118
└ Touch panel	└ Cleaning mode		Page 118
└ Security	└ Set up screen lock (Change screen lock)	└ None	Page 118
		└ Pattern	Page 118
		└ PIN	Page 118
		└ Password	Page 118
		└ Use visible pattern ^{*1}	Page 118
		└ Visible passwords	Page 118
		└ Use secure credentials	Page 119
		└ Install from SD card	Page 119
		└ Set password	Page 119
		└ Clear storage	Page 119
└ Applications	└ Running services		Page 119
└ Accounts & sync	└ Background data		Page 119
		└ Auto-sync	Page 119
		└ Account name	└ Synchronization interval
			└ Sync Contacts
			└ Sync Calendar
			└ Remove account
		└ Add account	
└ SD card & phone storage	└ Total space		Page 120
		└ Available space	Page 120
		└ Unmount SD card (Mount SD card)	Page 120

Main Category	Sub-Category	Setting	Reference
	└ User dictionary		Page 123
└ Accessibility	└ Key command on USB keyboard		Page 124
└ Date & time	└ NTP Server	└ Use NTP server	Page 124
	└ Set date		Page 124
	└ Select time zone		Page 124
	└ Set time		Page 124
	└ Use 24-hour format		Page 124
	└ Select date format		Page 124
└ Network Camera	└ Alarm notification		Page 125
	└ Alarm disarm time		Page 125
	└ Alarm port number		Page 125
└ About phone	└ Status	└ Network	Page 125
		└ Phone service	Page 125
		└ MAC address	Page 125
	└ Legal information	└ Open source licenses	Page 125
	└ Model number		Page 125
	└ OS version		Page 125
	└ Kernel version		Page 125
	└ Firmware version		Page 125
└ Administration ^{*3}			

*1 This setting is available only if an unlock pattern is specified.

*2 This setting is available only if [English (United Kingdom)] or [English (United States)] is selected in [Select language locale].

*3 This setting is for system administrators. For details, contact your system administrator or dealer.

Setting Item Details

Screen lock now

Setting	Description	Value Range	Default
Screen lock now	Activates the screen lock.	—	—

Network

Setting	Description	Value Range	Default	
MAC Address	Displays the MAC address.	—	—	
Basic Network settings	Connection mode	Selects whether to automatically acquire an IP address from a DHCP server (DHCP Settings) or enter an IP address manually (Static Settings). <input type="checkbox"/> DHCP <input type="checkbox"/> STATIC	DHCP	
	DHCP Settings	Selects whether to automatically acquire a DNS server or enter one manually when connecting using DHCP. When [Use the following settings] is selected, enter the DNS servers' addresses.	<input type="checkbox"/> Receive DNS server address automatically <input type="checkbox"/> Use the following settings	Receive DNS server address automatically
	—DNS1	When manual entry is selected for the DNS server, enter the address for DNS server 1 here.	xxx.xxx.xxx.xxx	—
	—DNS2	When manual entry is selected for the DNS server, enter the address for DNS server 2 here.	xxx.xxx.xxx.xxx	—
	Static Settings	When [STATIC] is set for [Connection mode] , enter the information here.	—	—
	—Static IP address	Enter the IP address here when [STATIC] is selected.	xxx.xxx.xxx.xxx	—
	—Subnet mask	Enter the subnet mask here when [STATIC] is selected.	xxx.xxx.xxx.xxx	—
	—Default gateway	Enter the default gateway here when [STATIC] is selected.	xxx.xxx.xxx.xxx	—
	—DNS1	Enter the address for DNS server 1 here when [STATIC] is selected.	xxx.xxx.xxx.xxx	—
	—DNS2	Enter the address for DNS server 2 here when [STATIC] is selected.	xxx.xxx.xxx.xxx	—

Setting		Description	Value Range	Default
Proxy server settings ^{*1*}	Use proxy server	Enables the use of a proxy server. If you enable this feature, specify values in [Proxy server address] , and [Proxy server port] .	On/Off	Off
	—Proxy server address	Enter the address of the proxy server.	xxx.xxx.xxx.xxx -or- a URL	—
	—Proxy server port	Enter the port number of the proxy server.	1 to 65535	8080
Embedded web ^{*2}		Enables web interface programming.	On/Off	Off
Network Test	Target address	Performs a network test. Enter an IP address or URL.	xxx.xxx.xxx.xxx -or- a URL	—

*1 The proxy server settings apply to browsing the web with the Browser application. Configure these settings if your network environment requires it.

*2 Depending on the unit's settings, you may not be able to change these settings. For details, consult your administrator.

Sound

General

Setting		Description	Value Range	Default
Volume	Ringtone	Sets the volume of the ringtone.	Level 0 to 7	5
	Media	Sets the volume for playing back music with the Music application, etc.	Level 0 to 15	11
	Alarm	Sets the alarm volume.	Level 0 to 7	6
	Use incoming call volume for notifications	Specifies whether to apply the volume of the incoming ringtone to the notification ringtone.	On/Off	On
	— Notification	When [Use incoming call volume for notifications] is off, sets the notification ringtone volume.	Level 0 to 7	5

Incoming calls

Setting	Description	Value Range	Default
Phone ringtone	Sets the incoming ringtone. If multiple lines are configured on your unit, you must first select which line to use the ringtone for. You can assign a different ringtone to each line. If you select [Automatic] , the ringtone assigned to the DN button (Page 92) the call arrives at will be used.	Automatic , Ringtone 1 to 32	Automatic
Melody for phone ringtone	Adds music saved to the SD card to ringtones.	Ringtone 10 to 32	—

Notifications

Setting	Description	Value Range	Default
Notification ringtone	Sets the sound to play when a notification occurs, such as for new e-mail or an error.	Sound 1 to 19	1

Feedback

Setting	Description	Value Range	Default
Audible touch tones	Sets whether sounds are heard each time a dial key is tapped.	On/Off	On
Audible selection	Sets whether sounds are heard when menu selections are made.	On/Off	On

Display

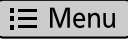
Setting	Description	Value Range	Default
Brightness	Sets the brightness of the screen. To set manually, deselect [Automatic brightness] and instead tap the slider to adjust the brightness.	<input type="checkbox"/> Automatic brightness or Level 1–18	14
Animation	Sets the animation effects for changing between screens. Some animations: Certain screen elements are animated by sliding into view. (For example, the menu displayed when  Menu is pressed.) All animations: The screen will slide into view each time the screen is changed.	<input type="checkbox"/> No animations <input type="checkbox"/> Some animations <input type="checkbox"/> All animations	Some animations

Setting	Description	Value Range	Default
Screen timeout	Sets the amount of time before the screen backlight automatically turns off.	<input type="checkbox"/> 1 minute <input type="checkbox"/> 5 minutes <input type="checkbox"/> 10 minutes <input type="checkbox"/> 30 minutes <input type="checkbox"/> 60 minutes <input type="checkbox"/> 120 minutes <input type="checkbox"/> 180 minutes <input type="checkbox"/> 300 minutes <input type="checkbox"/> Always On	1 minute

Touch panel

Setting	Description	Value Range	Default
Cleaning mode	Enables cleaning mode.	—	—

Security

Screen unlock pattern

Setting	Description	Value Range	Default
Set up screen lock/Change screen lock ¹	None	Disable the unlock setting for the screen lock.	—
	Pattern	Register the unlock pattern for the screen lock. Connect 4 to 9 points.	—
	PIN	Register a numeric PIN for the screen lock.	4 to 16 digits
	Password	Register a password for the screen lock.	4 to 16 alpha-numeric characters
Use visible pattern ²	Sets whether a trail of the input points is displayed when entering the unlock pattern.	On/Off	On

¹ If screen lock settings have been configured previously, **[Change screen lock]** will be displayed. Tapping **[Change screen lock]** displays the unlock screen, where you must enter the unlock pattern, PIN, or password to proceed.

² This setting is available only if an unlock pattern is specified.

Passwords

Setting	Description	Value Range	Default
Visible passwords	Sets whether entered password letters are momentarily displayed after they are input.	On/Off	On

Credential storage

Setting	Description	Value Range	Default
Use secure credentials	Allows applications to access credentials and to use them on a secured network. When enabling this, enter a password in [Set password] .	On/Off	Off
Install from SD card	Installs encrypted credentials from the SD card.	—	—
Set password	Sets or changes the password for the storage of credentials or certificates.	—	No password set
Clear storage	Erases all stored credentials and certificates, and resets the password.	—	—

Applications

Setting	Description	Value Range	Default
Running services	Displays applications that are currently running in the background. Applications can be stopped, or settings can be configured.	—	—

Accounts & sync

General sync settings

Setting	Description	Value Range	Default
Background data	Selects whether to enable applications to synchronize and to send and receive data while they are in the background.	On/Off	On
Auto-sync	Selects whether contacts and calendar events are automatically synchronized. To enable automatic synchronization, you must first select the [Background data] check box.	On/Off	On

Manage accounts

Setting		Description	Value Range	Default
Account name ^{*1}	Synchronization interval	Specifies the interval at which to automatically synchronize data. If you select [Automatic (Push)] , synchronized contacts and calendar events are updated on the unit soon after they are updated from the Google account. However, it may take a while for the update to occur.	<input type="checkbox"/> Automatic (Push) <input type="checkbox"/> Every 5 minutes <input type="checkbox"/> Every 10 minutes <input type="checkbox"/> Every 15 minutes <input type="checkbox"/> Every 30 minutes <input type="checkbox"/> Every hour	Every 15 minutes
	Sync Contacts	Enables the synchronizing of contacts.	On/Off	Off
	Sync Calendar	Enables the synchronizing of the calendar.	On/Off	Off
	Remove account	Remove the Google account information from the unit.	—	—
Add account ^{*2}		If no Google account is registered, newly registers your Google account.	—	—

*1 The name of the registered Google account is displayed.

*2 Only one account can be registered. An account cannot be added if one has already been registered.

SD card & phone storage

SD card

Setting	Description	Value Range	Default
Total space	Displays the total space of the SD Card.	—	—
Available space	Displays the amount of available space of the SD card.	—	—
Unmount SD card (Mount SD card)	Unmounts (releases the in-use status) of the SD card so that it can be safely removed. If an SD card has been unmounted, this setting changes to [Mount SD card] . Select this to mount the SD card again.	—	—
Format SD card	Formats the SD card.	—	—
Clear cache	Use this function when the Gallery application does not display image thumbnails correctly.	—	—

Internal phone storage

Setting	Description	Value Range	Default
Available space	Displays the amount of available space of the unit's internal memory.	—	—

Search

Web

Setting	Description	Value Range	Default	
Google search	Show web suggestions	Sets whether search suggestions are displayed as search text is being entered.	On/Off	On

Phone

Setting	Description	Value Range	Default	
Searchable items	Web	Searches the web, bookmarks, and the web browsing history.	On/Off	On
	Apps	Searches installed application names.	On/Off	On
	Contacts	Searches the names of contacts.	On/Off	On
	Music	Searches artist names, album names, and track names stored in the Music application.	On/Off	Off
Clear shortcuts	Clears the search history.		—	—

Language & keyboard

Setting	Description	Value Range	Default
Select language locale	Specifies the language to use for the interface. The USB keyboard type also changes to match this setting. If you select [Automatic] , the language and keyboard will be set automatically according to the configuration file.	Automatic, Deutsch, English (United Kingdom), English (United States), Español, Français (Canada), Français (France), Italiano, Nederlands, Русский, 日本語	English (United States)

Text settings

Setting	Description	Value Range	Default	
iWnn IME ¹	Select Language	Selects the language to use for the iWnn IME keyboard.	Dutch, English (UK), English (US), French, French (Canada), German, Italian, Japanese, Russian, Spanish	English (US)
	Sound on Key Press	Sets whether sounds are heard each time a key is tapped.	On/Off	Off
	Key Preview	Sets whether to display an enlarged image of a key when it is selected.	On/Off	On
	Auto Capitalization	Sets whether to capitalize the initial character when entering Latin characters.	On/Off	On
	Input Word Learning	Sets whether to remember the conversions that are selected.	On/Off	On
	Word Prediction	Sets whether to display possible conversions as characters are entered.	On/Off	On
	Typing Error Correction	Sets whether to display correction suggestions for incorrectly entered text.	On/Off	On
	Wildcard Prediction	Sets whether to predict possible conversions from the number of characters in the reading.	On/Off	On
	Lines of Candidate Area	Sets the number of lines to display for predictive text candidates.	1, 2	1

Setting		Description	Value Range	Default
iWnn IME (continued)	Mushroom	Sets whether to allow applications to use the Mushroom application for inputting common phrases.	Use/No use	No use
	User Dictionary	Edit the words in the user dictionary.	—	—
	Clear Learning Dictionary	Delete all the content from the learning dictionary.	—	—
Android keyboard	Sound on keypress	Sets whether a sound is heard each time a key is tapped.	On/Off	Off
	Auto-capitalization	Specifies whether to automatically capitalize the first letter.	On/Off	On
	Input languages	Sets which languages are available for the Android keyboard. For each language, you can set whether it is displayed.	Deutsch (Deutschland), English (United Kingdom), English (United States), Español (España), Français (Canada), Français (France), Italiano (Italia), Nederlands (Nederland), Русский (Россия)	All disabled
	Quick fixes²	Corrects commonly typed mistakes.	On/Off	On
	Show suggestions	Displays suggestions for words during input.	On/Off	On
	Auto-complete	Inputs the suggested word when a space or punctuation mark is input. This setting is available when [Show suggestions] is enabled.	On/Off	On
	User dictionary	Add or delete words from the user dictionary.	—	—

¹ In **[Select Language]**, if **[Japanese]** is selected as the keyboard language, the following settings will also be displayed in the **[iWnn IME]** settings: **[Keyboard Type]**, **[Flick Input]**, **[Flick Sensitivity]**, and **[Toggle Input]**.

² This setting is available only if **[English (United Kingdom)]** or **[English (United States)]** is selected in **[Select language locale]**.

Accessibility

Setting	Description	Value Range	Default
Key command on USB keyboard	Sets whether telephone functions can be performed by using a USB keyboard.	On/Off	Off

Date & time

Setting	Description	Value Range	Default	
NTP Server	Use NTP server	Specifies whether to use an NTP server. If enabled, enter information for [NTP server address] and [Synchronization Interval] .	On/Off	On
	—NTP server address	Sets the NTP server to use.	xxx.xxx.xxx.xxx	—
	— Synchronization Interval	Sets the interval for synchronization with the NTP server.	10–86400 s	43200
Set date^{*1}	Enter the date here when an NTP server is not used.	—	—	
Select time zone	Selects the time zone.	Select from 86 regions	GMT +00:00	
Set time^{*1}	Enter the time here when an NTP server is not used.	—	—	
Use 24-hour format	Specifies whether the time is displayed in a 24-hour format (when off, the time is displayed in a 12-hour format).	On/Off	On	
Select date format	Selects the format for the display of the date.	<input type="checkbox"/> Normal^{*2} <input type="checkbox"/> mm/dd/yyyy <input type="checkbox"/> dd/mm/yyyy <input type="checkbox"/> yyyy/mm/dd	Normal	

^{*1} When an NTP server has not been specified, when unit is turned off, time and date settings are lost. Each time the unit is restarted, the time and date settings must be made again.

^{*2} The date format associated with this setting depends on the value selected in **[Select language locale]** (Page 121).

Network Camera

Alarm settings

Setting	Description	Value Range	Default
Alarm notification	Sets the alarm notification method.	<input type="checkbox"/> Pop up live screen <input type="checkbox"/> Pop up live screen or status bar notification <input type="checkbox"/> Status bar notification <input type="checkbox"/> Off	Off
Alarm disarm time	Specifies the length of time after an alarm is issued for which subsequent alarms will be ignored.	<input type="checkbox"/> 2 seconds <input type="checkbox"/> 3 seconds <input type="checkbox"/> 4 seconds <input type="checkbox"/> 5 seconds <input type="checkbox"/> 6 seconds <input type="checkbox"/> 7 seconds <input type="checkbox"/> 8 seconds <input type="checkbox"/> 9 seconds <input type="checkbox"/> 10 seconds	2 seconds
Alarm port number	Specifies the port number used to receive alarm notifications.	1024–65535	1818

About phone

Setting	Description	Value Range	Default
Status	Network	Displays the status of the network.	—
	Phone service	Displays the status of the phone service for each configured line.	—
	MAC address	Displays the MAC address.	—
Legal information	Open source licenses	Displays open source license information.	—
Model number		Displays the model number.	KX-UT670
OS version		Displays the software version of the phone's interface.	2.2
Kernel version		Displays the kernel version.	2.6.32.9
Firmware version		Displays the firmware version. For details about updating the firmware, contact your system administrator or dealer.	—

Miscellaneous Information

Updating the Firmware

Updating the firmware to the latest version provides you with the latest features and improvements. For details, consult your administrator or dealer.

Using an SD Card

With an optional SD card, you can do the following:

- Add a photo stored on an SD card to a contact (Page 57)
- Save and load contacts to and from an SD card (Page 61)
- Set music stored on an SD card as a ringtone (Page 98)
- Set an image stored on an SD card as wallpaper (Page 95)
- Attach an image stored on an SD card to an e-mail (Page 81)
- Save files attached to e-mails to an SD card (Page 82)
- Update the firmware from an SD card (For details, consult your administrator or dealer.)

Precautions

To prevent data corruption and damage to the SD card, and to ensure correct operation of the unit, observe the following precautions:

- Do not remove the SD card or unplug the AC adaptor during the following operations:
 - Music playback
 - Backup
 - Reformatting
 - Reading data from the card
 - Erasing data from the card

Also, do not subject the unit to shaking or strong impacts. If power is supplied by the Ethernet cable, do not disconnect the Ethernet cable.

- Do not touch the terminal contacts on the back of the card.
- To prevent damage to the unit, do not use cards other than those approved for use with the unit.

Supported SD Cards

With this unit, you can use the following types of SD cards, which meet the SD specifications:

- SD memory card (2 GB or less)
 - SD memory card
 - miniSD card (with adaptor)
 - microSD card (with adaptor)
- SDHC memory card (32 GB or less)
 - SDHC memory card
 - miniSDHC card (with adaptor)
 - microSDHC card (with adaptor)
- SDXC memory card (128 GB)

- SDXC memory card
- microSDXC card (with adaptor)

For up-to-date information about SD cards that have been tested with this unit, refer to the following web site:

<http://www.panasonic.com/sip> (for users in the United States)

<http://panasonic.net/pcc/support/sipphone> (for users in Canada)

- Depending on the type of SD card, the time required for reading and writing operations may vary.
- Some SD cards may not be compatible with this unit.
- Multi-media cards are not supported.

Write Protection

SD memory cards can be locked to prevent formatting, deleting, and writing.

To lock an SD memory card, slide the switch on the side of the card to the "lock" position.

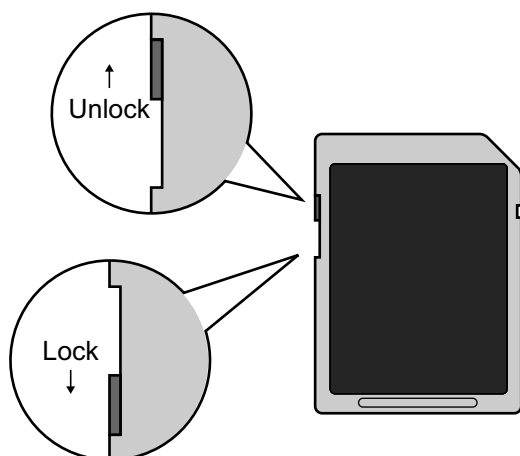

Backing up Data on an SD Card

Data saved on an SD card may be damaged or lost if the card is exposed to electromagnetic radiation or static electricity. Be sure to back up important data to a computer or other external source.

Inserting and Removing an SD Card

Inserting an SD card

1. With the label facing you, insert the card into the slot until it clicks.

Removing an SD card

1. Tap the status bar.
2. On the notification screen, tap **[Unmount SD card]**.
3. On the confirmation window, tap **[Unmount SD card]**.
4. Gently push the card in to release it, and then remove it.

Note

- The SD card can also be unmounted through settings (Page 120).

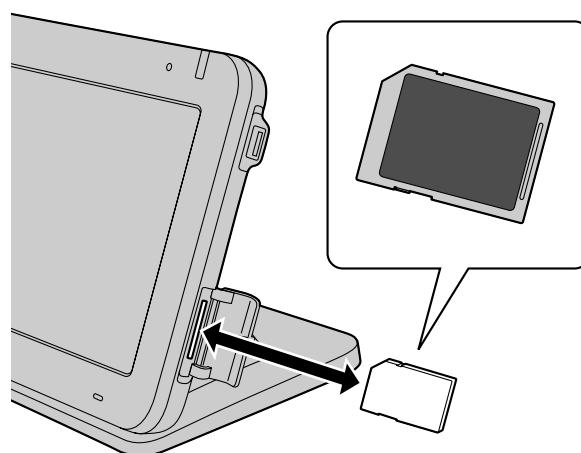

Formatting an SD Card

Before using an SD card, you should first format it.

IMPORTANT

- When you format a card, all data saved on the card is erased.
- While formatting a card, do not remove the card or unplug the AC adaptor. If power is supplied by the Ethernet cable, do not disconnect the Ethernet cable.
- While formatting a card, do not subject the unit to shaking or strong impacts.

1. On the Home screen, press **[Menu]**.
2. Tap **[Settings]**.
3. Tap **[SD card & phone storage]**.
4. Tap **[Unmount SD card]**.
5. Tap **[Format SD card]**.

Note

- When formatting is complete, you will be able to use **[Unmount SD card]**.

Setting up a Google Account for Synchronizing

By registering your Google account, you can synchronize contacts and calendar events between this unit and your Google account.

For example, by synching the Calendar application, events that you create on this unit will automatically be registered in your Google calendar on the web.

Registering a Google Account

Notice

- You must have an existing Google account to register it to this unit. You can obtain an account from the following URL:

<https://www.google.com/accounts/>

1. On the Home screen, press  **[Menu]**.
2. Tap **[Settings]**.
3. Tap **[Accounts & sync]**.
4. Tap **[Add account]**.
5. Enter your user name and password, and then tap **[Sign in]**.
6. When registration has completed, tap **[OK]**.

Note

- Only one account can be registered. If you have already registered an account, you cannot register any additional accounts.
- When a Google account is registered, existing contacts and calendar events are automatically added to the registered account.

Enabling Automatic Synchronization

1. On the Home screen, press  **[Menu]**.
2. Tap **[Settings]**.
3. Tap **[Accounts & sync]**.
4. Select both the **[Background data]** and **[Auto-sync]** check boxes.

Note

- By tapping the account name, you can select which data to synchronize and the interval at which to synchronize data (Page 120).

Synchronizing Manually

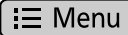
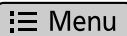
1. On the Home screen, press  **Menu**.
2. Tap **[Settings]**.
3. Tap **[Accounts & sync]**.
4. Tap the account name.
5. Press .
6. Tap **[Sync now]**.

Note

- If **[Auto-sync]** is enabled, you can select what data to synchronize (contacts, calendar) after step 4. Only selected data is synchronized. If **[Auto-sync]** is disabled, both contacts and calendars will be synchronized. For details about automatic synchronization, see page 128.

Removing Your Google Account Information

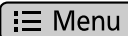
1. On the Home screen, press .
2. Tap **[Settings]**.
3. Tap **[Accounts & sync]**.
4. Tap the account name.
5. Tap **[Remove account]**.
6. On the confirmation window, tap **[Remove account]**.

Note

- If you remove the Google account, all contacts and calendar events will be deleted from the unit. If you do not want to delete your contacts, first export them to an SD card, and then import them after you have removed the account (Page 61).

Initializing the Unit

Initializing the unit resets all its settings to their factory default values. For details, consult your administrator or dealer.

Data Backup and Restore

You can back up and restore the unit's data to and from an SD card. For details, consult your administrator or dealer.

Cleaning the Unit

When you clean the unit, turn off the unit by unplugging the AC adaptor and/or disconnecting the Ethernet cable. Cleaning the unit while it is still on can result in erroneous behavior.

However, by enabling cleaning mode, you can wipe the display without turning the unit off (Page 130).

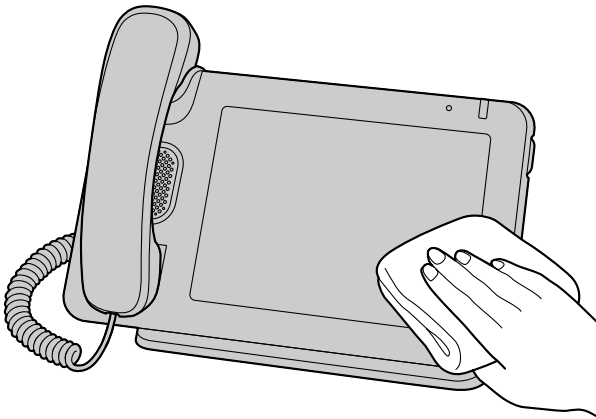

- Wipe the unit with a soft and dry cloth. If the unit becomes particularly dirty, apply a light kitchen cleanser to a soft cloth, wring the cloth thoroughly, and then wipe the unit. When finished, dry the unit with a soft and dry cloth.
- Do not clean the unit with cleaners that contain: petroleum, scouring powder, paint thinner, benzine, wax, hot water or powdered soap. When using chemical cleansers, follow the instructions on the label carefully.
- When wiping smudges off the display, use a soft and dry cloth. Touch the display only with the fleshy part of your fingers, and avoid touching it with your fingernails.

Enabling Cleaning Mode

To prevent incorrect operation while cleaning the unit, you can set the unit to ignore any operations from the key sheet and the display.

1. On the Home screen, press  **Menu**.
2. Tap **[Settings]**.
3. Tap **[Touch panel]**.
4. Tap **[Cleaning mode]**.

Note

- This mode can be enabled only when the unit is idle.

- When in cleaning mode, the message/ringer lamp flashes green.
- If you receive a call, cleaning mode will be canceled and you can answer the call.

Exiting Cleaning Mode

You can exit cleaning mode by lifting the handset off its cradle.

Note



- If a USB keyboard is connected, you can also exit cleaning mode by pressing an alphanumeric or symbol key on the keyboard.

Troubleshooting

If you experience trouble, refer to the information in this section. If the problem persists, disconnect and then reconnect the AC adaptor and/or Ethernet cable.

Before troubleshooting, confirm all connections (Page 104), and ensure that power is being supplied from the Ethernet cable. If you are using an AC adaptor to supply power, ensure that the AC outlet the unit is connected to is receiving power.

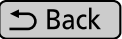
General Use

Issue	Possible Cause & Solution
The display is blank.	<ul style="list-style-type: none"> The unit is still starting up. → While the unit is starting up, the display will be blank for a while. Wait for the unit to finish starting up. The display's backlight is off. → Lift the handset or touch the display.
The unit does not respond to operations or does not operate as expected.	<ul style="list-style-type: none"> Some cables or cords are not connected correctly. → Check whether the connections are correct (Page 104). If some connections are incorrect, disconnect all cables and cords and then connect them again. Your connection settings are incorrect. → Consult your administrator to confirm that your settings are correct.
The display is not shown well.	<ul style="list-style-type: none"> The screen's brightness is set too low. → Adjust the display's brightness (Page 117). The ambient light sensor is covered by something. → Check that the ambient light sensor is not covered or blocked. If it is, remove whatever is blocking it.
The previous screen is not displayed even when I press  .	<ul style="list-style-type: none"> The Home screen is displayed. → You cannot go back from the Home screen. You must reopen the screen you want to view again.
I forgot my password.	<ul style="list-style-type: none"> Reinitialize the unit, and then set a password again. For details about reinitializing the unit, consult your administrator or dealer.
The display of the date and time is wrong.	<ul style="list-style-type: none"> This unit can retrieve the date and time from an NTP server. The NTP server settings may be incorrect. → For details about NTP server settings, consult your administrator or dealer. If the unit cannot connect to the NTP server, you can also set the date and time manually (Page 124).
Changes to settings, contacts, etc., were not saved.	<ul style="list-style-type: none"> You answered a call while making changes. → If you answer a call before you finish making changes, the changes you made up until then will not be saved. Make the necessary changes again. You moved to another screen while making changes. → If you move to another screen while making changes, those changes may not be saved even if you press  to return to the previous screen. Make the necessary changes again.

Issue	Possible Cause & Solution
The display goes dark while registering or editing information.	<ul style="list-style-type: none"> You have not performed any operations for a certain length of time. → If no operations are performed for a certain length of time, the screen saver will automatically start.
Nothing happens when I touch the display.	<ul style="list-style-type: none"> A protective film is covering the display. → Remove any film from the display. The display is dirty. → Clean the display.
I cannot open an e-mail attachment.	<ul style="list-style-type: none"> The file may be an unsupported type, or the data may be corrupt. → Save the attachment to an SD card, and then try opening it in the Gallery application. If the attachment still does not open, try opening it on a computer. (For details about saving an attachment to an SD card, see page 82. For details about displaying an image in Gallery, see page 85.) The e-mail account is an IMAP account. → If the e-mail account's type is IMAP, attachments larger than 4 MB cannot be opened. Either use an account that uses POP3, or register the account again using POP3 as the account type (Page 83).
The Music application quits unexpectedly when I try to open a file.	<ul style="list-style-type: none"> The file may be an unsupported type, or the data may be corrupt. → Try playing back the file stored on the SD card on a computer or other device.
The Gallery application quits unexpectedly when I try to open a file.	<ul style="list-style-type: none"> The file may be an unsupported type, or the data may be corrupt. → Try viewing the file stored on the SD card on a computer or other device.
The times listed in the incoming call log or the times listed on sent e-mails are not correct.	<ul style="list-style-type: none"> The date and time are not set. → Set the date and time (Page 124).

Making and Receiving Calls

Issue	Possible Cause & Solution
I cannot make calls.	<ul style="list-style-type: none"> The phone number was entered incorrectly. → Confirm that you have entered the phone number of the other party correctly (Page 51). If the problem is not resolved, contact your administrator or dealer.
I cannot redial by selecting an entry in a call log.	<ul style="list-style-type: none"> The number you are trying to redial is too long. → If the dialed number is longer than 32 digits, it cannot be redialed correctly (Page 51).
The unit does not ring when a call is received.	<ul style="list-style-type: none"> The ringer is turned off. → Press  while a call is being received, or change the ringer volume setting (Page 116).

Issue	Possible Cause & Solution
I cannot transfer a call.	<ul style="list-style-type: none"> You are in a 3-party conference call. → When the 3-party conference call ends, try the operation again (Page 55).
I cannot do a blind transfer.	<ul style="list-style-type: none"> You are either in the middle of transferring a call or you are in a 3-party conference call. → Either cancel the transfer or end the 3-party conference call, and then try the operation again (Page 55).
I cannot establish a 3-party conference call.	<ul style="list-style-type: none"> You are in the middle of transferring a call. → Cancel the transfer, and then try the operation again (Page 55).
I cannot assign anything to a flexible button.	<ul style="list-style-type: none"> You are on a call or the screen lock is active. → When the call ends, try the operation again. → Unlock the screen lock, and then try the operation again. Some flexible buttons may already have phone functions assigned to them through configuration file programming. → These buttons cannot be modified. For details, consult your administrator.

Sound Quality

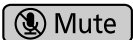

Issue	Possible Cause & Solution
The other party cannot hear my voice.	<ul style="list-style-type: none"> The unit is muted. → If the light on  is flashing red, press  to turn off mute (Page 19). The microphone is blocked. → During a call, avoid blocking the microphone with your hands or other objects.



Issue	Possible Cause & Solution
<p>While on speakerphone, the other party's voice breaks up, or I hear an echo of my own voice.</p>	<ul style="list-style-type: none"> • Just after a call begins, the unit may not have yet adjusted itself to the call's environment. <ul style="list-style-type: none"> → Just after a call begins, take turns with the other party talking to each other. The unit will adjust itself in accordance with the call environment so that both you and the other party can hear each other as clearly as possible. • You are too far away from the microphone. <ul style="list-style-type: none"> → Try speaking closer to the microphone. • The environment is not suited to speakerphone calls. <ul style="list-style-type: none"> → Do not use the unit within 2 m (7 ft) of radios, televisions, office equipment, microwave ovens, air conditioners, or other devices that emit electrical noise. → If using the unit in a room with windows, close the curtains or blinds to prevent echoes. → Use the unit in a quiet environment. • The unit was moved during a call. <ul style="list-style-type: none"> → Do not move the unit while on a call. • The microphone is blocked. <ul style="list-style-type: none"> → During a call, avoid blocking the microphone with your hands or other objects. • The other party is using a half-duplex speakerphone. <ul style="list-style-type: none"> → If the other party is using a half-duplex speakerphone, sound may cut out occasionally during calls. For best performance, the other party should use a full-duplex speakerphone.
<p>I cannot hear the other party through the handset.</p>	<ul style="list-style-type: none"> • The handset is not connected correctly. <ul style="list-style-type: none"> → Check whether the handset is connected correctly. If it is not connected correctly, connect it again (Page 107).

Contacts

Issue	Possible Cause & Solution
I cannot add a new contact.	<ul style="list-style-type: none"> The maximum number of contacts are already registered. → Delete unnecessary contacts (Page 59).
Contact information I loaded from an SD card contains garbled text.	<ul style="list-style-type: none"> The character encoding of the vCard file you imported was not UTF-8. → Use the UTF-8 character encoding when saving vCard files you want to load into the unit (Page 61).

Network Camera

Issue	Possible Cause & Solution
I cannot connect to a network camera.	<ul style="list-style-type: none"> The settings for the camera are not configured correctly. → Check whether the settings are correct, and then configure the settings again as necessary (Page 64). No network cameras are registered. → Register a network camera (Page 64). The settings for a network camera registered to a contact are not configured correctly. → Check whether the settings registered to the contact are correct, and then configure the settings again as necessary (Page 58). The network camera is not functioning properly. → Refer to the documentation of the network camera.
The video feed does not display.	<ul style="list-style-type: none"> The network camera is not configured to use H.264 as its video codec. → Change the network camera's settings so that it uses H.264 as its video codec. For details, consult the network camera administrator. The stream you have selected to view (Page 64) is not enabled. → Change the network camera's settings to enable the appropriate stream. For details, consult the network camera administrator. The resolution of the video feed is more than 1280 × 720 pixels. → Change the network camera's settings so that the video feed's resolution is 1280 × 720 pixels or less. For details, consult the network camera administrator.
Some or all of the controls are unavailable.	<ul style="list-style-type: none"> The network camera you are connected to does not support these functions. → Refer to the documentation of the network camera, or consult your administrator. Access limitations have been set for the network camera. → Consult the network camera administrator.
Even when I tap the video feed, the display area does not change.	<ul style="list-style-type: none"> The network camera is at the furthest position it can move to.
Even when I tap  /  , the network camera does not zoom in/out.	<ul style="list-style-type: none"> The network camera is at its zoom in/out limit.

Issue	Possible Cause & Solution
Even when I tap  , the network camera does not return to its home position.	<ul style="list-style-type: none"> A home position is not configured in the network camera's settings. → Consult the network camera administrator.
Even when I tap  , a call is not made.	<ul style="list-style-type: none"> The phone number registered on the [Camera Registration] screen is not correct. → Check whether the setting is correct, and enter the setting again as necessary (Page 64). You are already on a call. → When you finish the call, tap  again.

Note

- If the information provided here does not resolve your issue, refer to the documentation of the network camera, or consult your network camera administrator.

SD Cards

Issue	Possible Cause & Solution
The SD card is not recognized.	<ul style="list-style-type: none"> The SD card is not formatted according to the SD standard. → This unit does not support SD cards that are not formatted according to the SD standard. Format the SD card with this unit, and then try again (Page 127).
I cannot save to an SD card.	<ul style="list-style-type: none"> The SD memory card is not compatible with this unit. → Use an SD card that is compatible with this unit (Page 126). The SD card is not formatted correctly. → Format the SD card (Page 127). The SD card is not completely inserted. → Remove the SD card, and then reinsert the card, making sure to insert it completely (Page 127). The write-protection switch on the SD is set to the "lock" position. → Remove the SD card, set the write-protection switch on the card to the unlock position, and then reinsert the card (Page 127).
Images saved on the SD card are not displayed on the [Select wallpaper from Gallery] screen.	<ul style="list-style-type: none"> The image size is unsupported. → For the Phone screen wallpaper, use an image with a resolution of 800 × 455 pixels (Page 95).
Music saved on the SD card is not displayed on the ringtone selection screen.	<ul style="list-style-type: none"> You have not registered the file to the ringtone list in the Music application. → In the Music application, register the music you want to use as a ringtone to the ringtone list, and then add it as a ringtone in [Melody for phone ringtone] (Page 98).
When I install a certificate, the file names of files on the SD card are not displayed.	<ul style="list-style-type: none"> Change the file name to have 9 characters or more, and then try again.

Issue	Possible Cause & Solution
<p>Thumbnails of images on the SD card are not displayed, or different images are displayed.</p>	<ul style="list-style-type: none"> • The SD card was not unmounted before it was removed from the unit. <ul style="list-style-type: none"> → Unmount the SD card before removing it (Page 120). To display the correct thumbnail images, clear the SD card's cache (Page 120).

USB Devices

Issue	Possible Cause & Solution
<p>The USB device I connected does not work.</p>	<ul style="list-style-type: none"> • You connected a USB device that this unit does not support. <ul style="list-style-type: none"> → This unit supports only standard USB keyboards. • The maximum number of chained hubs has been exceeded. <ul style="list-style-type: none"> → The maximum number of hubs you may chain together is 2.
<p>The keyboard I connected does not work.</p>	<ul style="list-style-type: none"> • The USB keyboard is not connected correctly. <ul style="list-style-type: none"> → Check whether the keyboard is connected correctly (Page 107). If it is not connected correctly, disconnect it, and then connect it again.
<p>Some of the keys on the USB keyboard do not work.</p>	<ul style="list-style-type: none"> • The locale of the keyboard is different from the locale selected for the unit. <ul style="list-style-type: none"> → When you specify a locale for the unit in the [Language & keyboard] settings (Page 121), the USB keyboard type is set to the same locale. Therefore, if you use a keyboard designed for a different locale from the one specified, the character that appears on the screen when you press a key may differ from the character printed on the keyboard. (For example, if the locale is "French" but you use a US keyboard, pressing the [Q] key causes an "A" to appear on the screen.) • You are using a key that is not supported by this unit. <ul style="list-style-type: none"> → Confirm which keys are supported (Page 29).

Function Settings

Issue	Possible Cause & Solution
<p>I cannot configure settings.</p>	<ul style="list-style-type: none"> • You are on a call. <ul style="list-style-type: none"> → When you finish the call, try configuring the settings again. • You moved to another screen while configuring settings. <ul style="list-style-type: none"> → If you move to another screen while making changes, those changes may not be saved. Configure the settings again as necessary.

Error Messages

Issue	Possible Cause & Solution
Network error Address conflict.	<ul style="list-style-type: none"> • The network settings are incorrect. → Consult your administrator or dealer.
Network error Invalid IP address.	
Check LAN cable.	<ul style="list-style-type: none"> • The Ethernet cable is not connected correctly. → Check whether the Ethernet cable is connected correctly to the unit (Page 104). If it is not connected correctly, disconnect it, and then connect it again.
The clock is not adjusted because an NTP server is not specified.	<ul style="list-style-type: none"> • An NTP server is not specified. → Tap [Enter NTP], and then configure the NTP server settings (Page 124). Consult your administrator or dealer for details about the settings for an NTP server.

Specifications

Item	Specification
Display	7-inch touch display WVGA (800 × 480 pixels) 262,000 colors
VoIP Connection Method	SIP
VoIP Audio Codec	G.722, G.711, G.729a
Network Camera Codec	H.264
Ethernet Interface	10Base-T/100Base-TX/1000Base-T
IP Address Mode	Automatic (DHCP), Manual (Static)
Speaker	1
Microphone	1
Ethernet Port (LAN)	2 (RJ45)
USB Port	1 (USB 2.0 Host)
SD Card Slot	1
Headset Jack	1 (ø 2.5 mm [³ / ₃₂ in])
EHS Jack	1 (ø 3.5 mm [¹ / ₈ in], EHS only)
Ambient Light Sensor	1
Dimensions (Width × Depth × Height)	Approx. 270 mm × 180 mm × 220 mm (11 in × 7.1 in × 8.7 in) (When the angle is set to 65° and including the handset and stand)
Weight	Approx. 1,300 g (2.9 lb) (Including handset and handset cord)
PoE	IEEE 802.3af compliant (LAN port only)
Power Consumption	PoE Stand-by: approx. 5.2 W (with backlight off) Talking: approx. 7.0 W AC Adaptor Stand-by: approx. 4.6 W (with backlight off) Talking: approx. 6.2 W
Maximum Power Consumption	PoE: 12.9 W AC Adaptor: 11.5 W
Operating Environment	0 °C to 40 °C (32 °F to 104 °F)

Revision History

Software File Version 01.030

Added Contents

- Receiving Alarms from Network Cameras (Page 69)
- Setting Items
 - Accounts & sync (Page 119)
 - Network Camera (Page 125)
- Setting up a Google Account for Synchronizing (Page 128)

Changed Contents

- Using a USB Keyboard (Page 29)
- Soft Keys (Page 38)
- Adding Contacts (Page 57)
- Saving/Loading Contact Information to/from an SD Card (Page 61)
- Registering a Network Camera (Page 64)
- Switching Automatically among Multiple Cameras (Page 67)
- Displaying Calendar (Page 78)
- Forward/Do Not Disturb (Page 90)
- Phone Function Types (Page 92)
- Changing the Wallpaper (Page 95)
- Setting a Ringtone (Page 98)
- Setting Items
 - SD card & phone storage (Page 120)
 - Language & keyboard (Page 121)
 - Date & time (Page 124)
 - About phone (Page 125)
- Troubleshooting
 - SD Cards (Page 136)

Index

A

AC adaptor 104
 Accessibility 100
 Accessories 17
 Alarm (network camera) 69
 Ambient light sensor 18
 Application dock 31
 Applications 71
 Browser 74
 Calculator 77
 Calendar 78
 Clock 71
 Email 81
 Gallery 85
 Music 87
 Auto pan 68
 Automatic Answer 91

B

Back (Key Sheet button) 19

C

Cable cover 20
 Call log, deleting an entry 52
 Call record 40
 Call waiting 53
 Cleaning 130
 Cleaning mode 130
 Conference call 55
 Configuration 111
 About phone 125
 Accessibility 124
 Accounts & sync 119
 Applications 119
 Date & time 124
 Display 117
 Language & keyboard 121
 Network 115
 Network Camera 125
 Screen lock now 115
 SD card & phone storage 120
 Search 121
 Security 118
 Sound 116
 Touch panel 118
 Connections 104
 Contacts
 Adding 57
 Deleting 59
 Joining 61
 Loading from an SD card 62
 Save format 61
 Saving to an SD card 61
 Searching 60
 Sending as e-mail attachment 62
 Separating 61
 Controls, locations of 18

Current tab 37

D

DC jack 22
 Dial key display 35
 Do Not Disturb 90

E

EHS jack 21
 Emergency number
 Calling 52
 Registration 30
 Enter (Key Sheet button) 19
 Ethernet cable 104

F

Flexible buttons, customizing 91
 Folders 96
 Forward 90

G

Google account 128

H

Handset 17
 Connecting 107
 Hooking during a conversation 110
 Handset cord 17
 Handset hook 18
 Handset jack, modular 21
 Hands-free mode 24
 Headset 104
 Headset mode 93
 Headset jack 21
 Hold 54
 Hold tab 37
 Home (Key Sheet button) 19

I

Icons 46
 Incoming Call tab 40
 Incoming tab 37
 Initializing 129

K

Key Sheet 19
 Keyboard, Android 27
 Keyboard, iWnn IME 25
 Keyboard, USB 29
 Connecting 107

L

LAN port 22, 104

M

Making a call 51

Index

Menu (Key Sheet button) 19
Message/Ringer lamp 18, 22
Microphone 18
Missed Call tab 40
Multiple incoming calls 53
Mute 56
Mute (Key Sheet button) 19

N

Navigation key (Key Sheet button) 19
Network camera
 Alarm 69
 Brightness 68
 Calling a phone 66
 Centering 66
 Changing the view area 65
 Home position 66
 Preset sequence 68
 Presets 67
 Registering 64
 Selecting 65
 Zooming in/out 65

O

One-touch dialing button 52
Optional accessories 17
Outgoing Call tab 40

P

PC port 22, 104
Phone (Key Sheet button) 19
Phone, basic operation 24
Photo 41
Pre-dial 51

Q

Quick Contact 51

R

Receiving a call 53
Redial 51
RESET button 22
Ringtones 98
 Setting a ringtone to a contact 63
 Using music on an SD card 98

S

Schedule display 35, 97
Screen lock 94
Screens
 Application screen 34
 Call Log screen 40
 Calling screen 37
 Contacts screen 41
 Flexible Button screen 42
 Home screen 31
 Lock screen 44
 Network Camera Viewer 43

Notification screen 33
Phone screen 35
Status bar 32
SD card 126
 Formatting 127
 Locking/Unlocking 127
SD card slot 20
Shortcuts 96
Soft keys 38
Speaker 18
Specifications 139
SP-Phone (Speakerphone)/Headset (Key Sheet button) 19
Stand 17
 Attaching 102
Swipe (definition) 23
Switching automatically (network camera) 67
Synchronization settings 128

T

Tap (definition) 23
Text entry 25
Touch (definition) 23
Touch and hold (definition) 23
Touch display 18
 Operation 23
Tracking, automatic 69
Transfer 55
Transfer, blind 55
Troubleshooting 131

U

USB port 20

V

Ventilation opening 22
Voice messages, checking 56
Volume (Key Sheet button) 19

W

Wall mounting 108
Wallpaper 95
Web User Interface Programming 99
Widgets 96
Wire openings 22

WALL MOUNTING TEMPLATE

1. Drive the screws into the wall as indicated.
2. Hook the unit onto the screw heads.

Note:

Make sure to set the print size to correspond with the size of this page. If the dimensions of the paper output still deviate slightly from the measurements indicated here, use the measurements indicated here.

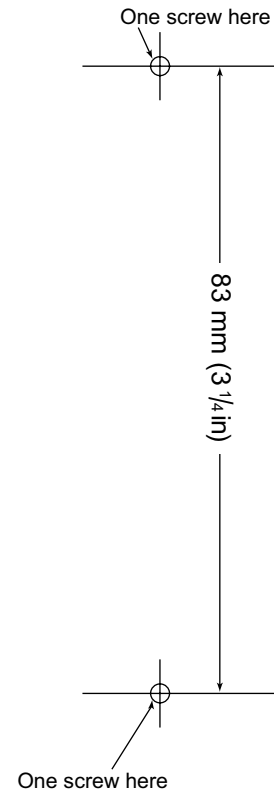

Panasonic Corporation of North America

One Panasonic Way, Secaucus, New Jersey 07094

<http://www.panasonic.com/sip>

Panasonic Canada Inc.

5770 Ambler Drive, Mississauga, Ontario, L4W 2T3

<http://www.panasonic.ca>

Copyright:

This material is copyrighted by Panasonic System Networks Co., Ltd., and may be reproduced for internal use only. All other reproduction, in whole or in part, is prohibited without the written consent of Panasonic System Networks Co., Ltd.

© Panasonic System Networks Co., Ltd. 2011